

PIAGGIO WOULD LIKE TO THANK YOU

for choosing one of its products. We have prepared this booklet to help you to get the very best from your scooter. Please read it carefully before riding the scooter for the first time. It contains information, tips and precautions for using your scooter. It also describes features, details and devices to assure you that you have made the right choice. We believe that if you follow our suggestions, you will soon get to know your new vehicle and it will serve you well for a long time to come. This booklet forms an integral part of the scooter; should the scooter be sold, it must be transferred to the new owner.

# Beverly 500



The instructions given in this manual are intended to provide a clear, simple guide to using your scooter; this booklet also details routine maintenance procedures and regular checks that should be carried out on the vehicle at an **authorised Dealer or Service Centre**. The booklet also contains instructions for simple repairs. Any operations not specifically described in this manual require the use of special tools and/or particular technical knowledge: to carry out these operations refer to any **authorised Dealer or Service Centres**.



### **Personal safety**

Failure to completely observe these instructions will result in serious risk of personal injury.



### **Safeguarding the environment**

Sections marked with this symbol indicate the correct use of the vehicle to prevent damaging the environment.



### **Vehicle intactness**

The incomplete or non-observance of these regulations leads to the risk of serious damage to the vehicle and sometimes even the invalidity of the guarantee.

*The signs that you see on this page are very important. They are used to highlight those parts of the booklet that should be read with particular care. As you can see, each sign consists of a different graphic symbol, making it quick and easy to locate the various topics.*



# INDEX

<b>VEHICLE</b> .....	7	Safe driving.....	28
Dashboard.....	8	Accessories.....	29
Analogue instrument panel.....	8	<b>MAINTENANCE</b> .....	31
Clock.....	9	Engine oil level.....	32
Key switch.....	10	Engine oil level check.....	32
Locking the steering wheel.....	10	Engine oil top-up.....	32
Releasing the steering wheel.....	10	Warning light (insufficient oil pressure).....	32
Switch direction indicators.....	10	Engine oil change.....	33
Horn button.....	11	Hub oil level.....	34
Light switch.....	11	Tyres.....	36
Start-up button.....	11	Spark plug dismantlement.....	38
Engine stop button.....	12	Removing the air filter.....	39
The immobilizer system.....	12	Air filter cleaning.....	40
Keys.....	12	Cooling fluid level.....	41
Immobilizerdevice enabled indicator led.....	13	Checking the brake oil level.....	42
Operation.....	13	Braking system fluid top up.....	43
Programming the immobilizer system.....	14	Battery.....	44
Accessing the fuel tank.....	15	Use of a new battery.....	45
Power supply socket.....	16	Checking the electrolyte level.....	45
Identification.....	17	Long periods of inactivity.....	45
Saddle opening button.....	18	Fuses.....	47
Rear top box opening.....	18	Front light group.....	52
<b>USE</b> .....	19	Headlight adjustment.....	52
Checks.....	20	Front direction indicators.....	54
Refuelling.....	20	Rear optical unit.....	54
Tyre pressure.....	22	Number plate light.....	56
Shock absorbers adjustment.....	23	Helmet compartment lighting bulb.....	56
Running in.....	24	Rear-view mirrors.....	56
Starting up the engine.....	24	Front and rear disc brake.....	57
Difficult start up.....	25	Puncture.....	58
Stopping the engine.....	26	Periods of inactivity.....	59
Stand.....	26	Cleaning the vehicle.....	59
Automatic transmission.....	27	<b>TECHNICAL DATA</b> .....	65

Kit equipment.....	69
<b>SPARE PARTS AND ACCESSORIES.....</b>	<b>71</b>
Warnings.....	72
<b>PROGRAMMED MAINTENANCE.....</b>	<b>75</b>
Scheduled maintenance table.....	76

# Beverly 500



**PIAGGIO®**



**Chap. 01  
Vehicle**

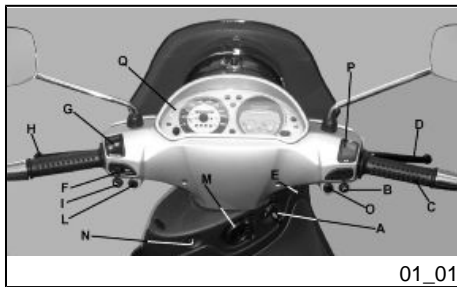

01\_01

## Dashboard (01\_01)

A = Ignition key-switch

B = Starter button

C = Throttle control

D = Front brake lever

E = Cooling hatch

F = Turn signal switch

G = Light switch with passing

H = Rear brake control

I = Horn button

L = Switch pre-installation

M = Bag hook

N = Saddle opening electric switch

O = Switch pre-installation

PI = Engine cut-off switch

Q = Instrument panel

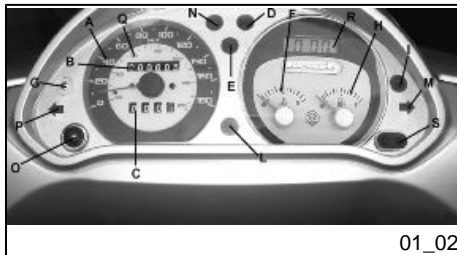

01\_02

## Analogue instrument panel (01\_02)

A = Speedometer (km/h)

B = Odometer

C = Trip odometer

D = Oil pressure warning light

E = High-beam warning light



**F** = Water temperature gauge

**G** = Immobilizer LED

**H** = Fuel gauge

**I** = Low fuel warning light

**L** = Headlight warning light

**M** = Right turn indicator warning light

**N** = Injection telltale light

**O** = Odometer reset button

**P** = Left turn indicator warning light

**Q** = Speedometer (mph)

**R** = Digital clock

**S** = Clock controls

### **Clock (01\_03)**

Hours and minutes are displayed in a 1 to 12 format on the instrument panel; operating the function selection button «1», month, day and seconds are also displayed besides hours and minutes. Adjust above functions with button «2» until the desired function flashes and it can be adjusted using the key «1».



01\_03

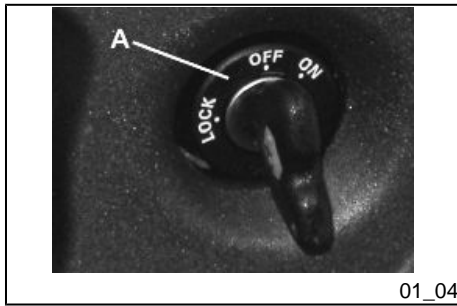

01\_04

### Key switch (01\_04)

**LOCK**= Ignition barred, key can be removed, mechanical antitheft device activated.

**OFF**= Ignition barred, key can be removed, mechanical antitheft device deactivated.

**ON**= Prestarting position, key cannot be removed, mechanical antitheft device deactivated.

### Locking the steering wheel

Turn the handlebar to the left as far as it will go, turn the key to position «**LOCK**» and remove the key.

### Releasing the steering wheel

Reinsert the key and turn it to «**OFF**».

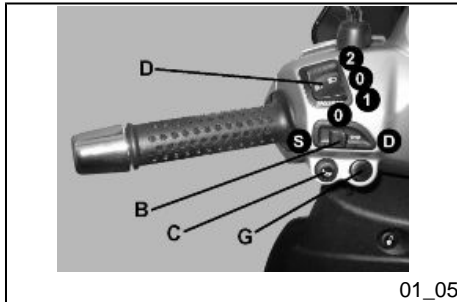

01\_05

### Switch direction indicators (01\_05)

Lever towards "S" = Left turn indicator is switched on;

Lever towards "D" = Right turn indicator is switched on;

The lever returns automatically to position "0" and the turn indicator "B" remains on; to switch off, push the lever again.

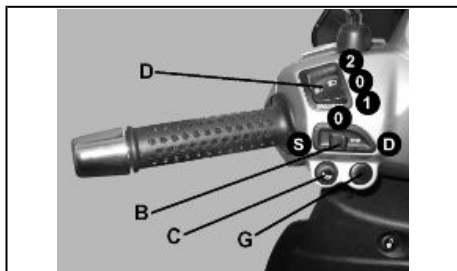

01\_06

### Horn button (01\_06)

Push the «C» button to sound the horn.

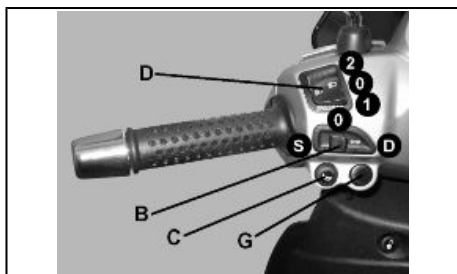

01\_07

### Light switch (01\_07)

0 = Dipped beam/tail light

1 = Upper beam

2 = Passing (flashing)

#### WARNING

THE SIDELIGHT BULB REMAINS ALWAYS ON IF THE KEY IS SET TO «ON».

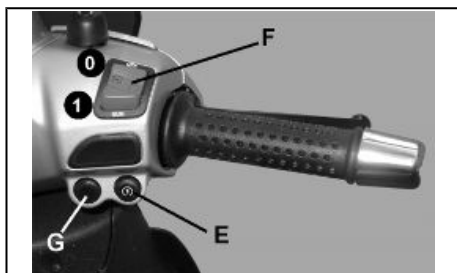

01\_08

### Start-up button (01\_08)

Starter button «E»

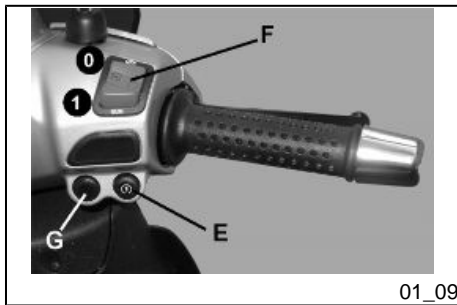

## Engine stop button (01\_09)

0 = OFF

1 = RUN

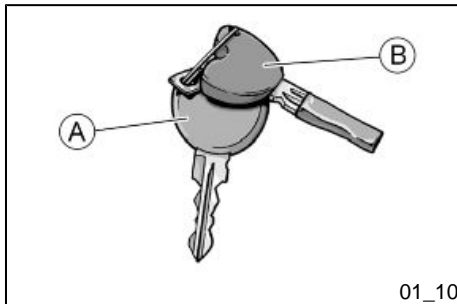

## The immobilizer system

In order to enhance theft protection, the scooter is equipped with a «**PIAGGIO IMMOBILIZER**» electronic engine locking device that is activated automatically when the starter key is removed. Upon start-up, the «**PIAGGIO IMMOBILIZER**» system checks the starter key, and only if this key is recognised will the immobilizer system allow the scooter to be started.

## Keys (01\_10, 01\_11, 01\_12)

Two types of keys come with the vehicle. The red-handgrip key "A" is the "**MAS-TER**" key. Only a single copy of this key is supplied, which is necessary to program all your other keys and for your dealer to perform some maintenance operations. For this reason it is advised that it be used only in exceptional circumstances. The black key "B" (single copy supplied) is used for normal operations such as:

- engine start up
- glove-box opening

Together with the keys comes a CODE CARD which is imprinted with the mechanical code of the keys.

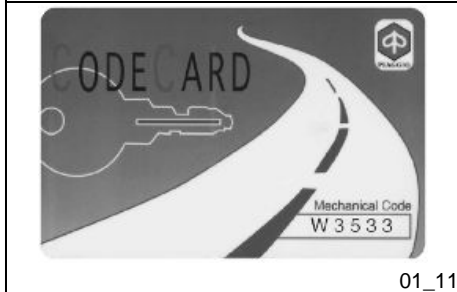

**WARNING**

**LOSING THE RED KEY PREVENTS ANY REPAIRS OF THE "PIAGGIO IMMOBILIZER" SYSTEM AND THE ENGINE CONTROL UNIT.**

**WARNING**

**KEEP THE "CODE CARD" AND THE RED HANDGRIP KEY IN A SAFE PLACE (NOT ON YOUR VEHICLE).**

**Immobilizerdevice enabled indicator led (01\_13)**

Activation of the «**PIAGGIO IMMOBILIZER**» system is signalled by a flashing warning light «**G**» (see «**Analogue instrument panel**» section).

In order to reduce battery discharge, the indicator LED turns off automatically after 48 hours of uninterrupted functioning.

Should the system fail, different LED flashing patterns will be provided by an **authorised Piaggio-Gilera service centre** with information on the type of fault detected.

**Operation**

Every time the starter key is removed in the "**OFF**" or "**LOCK**" position, the safety system activates the immobilizer system. Turning the key to "**ON**" disables the engine lock, provided that the safety system recognises the code transmitted by the key. If the code is not recognised, turn the key first to "**OFF**" and then to "**ON**"; if the lock cannot be disabled, try with the other key supplied (red-coloured). If the engine cannot be started, contact an **authorised Piaggio service centre**, which is provided with the electronic equipment required to detect and repair the system. The immobiliser is activated even when the engine is switched off with the engine cut-off switch. This happens even if the starter key is in position "**ON**". When additional keys are required, please note that data storage (up to 7 keys max.) must be done on all keys, both new ones and existing ones. Take the key with the red grip and all the black keys supplied to an **authorised Piaggio service centre**. The codes of keys not submitted for the

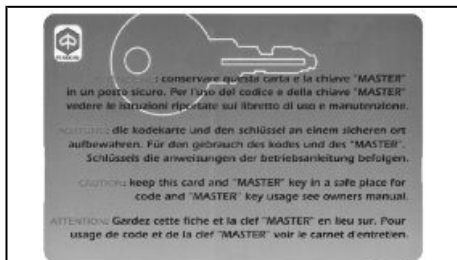

01\_12

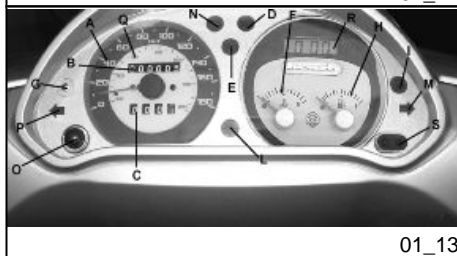

01\_13

new storage procedure are deleted from the memory. Any lost keys will therefore not be enabled to start the engine.

#### **WARNING**



**EACH KEY HAS ITS OWN AND UNIQUE CODE, WHICH MUST BE STORED BY THE SYSTEM CONTROL UNIT.**

**VIOLENT SHOCKS MAY AFFECT THE ELECTRONIC COMPONENTS OF THE KEY.**

**IF OWNERSHIP OF THE VEHICLE IS TRANSFERRED, THE RED-HANDGRIP KEY (AS WELL AS THE OTHER KEYS) AND THE "CODE CARD" MUST ALSO BE TRANSFERRED TO THE NEW OWNER.**

### **Programming the immobilizer system**

The procedure for programming the «**PIAGGIO IMMOBILIZER**» system and/or for storing other key codes is described below.

The programming procedure should be carried out with the engine stop switch set to «**RUN**».

#### **Procedure start - red key**

Insert the red-handgrip key in the switch key (in "**OFF**" position) and turn it to "**ON**". After 1 - 3 seconds, turn the key to "**OFF**" again and pull it out.

#### **Intermediate step - black key**

After pulling out the red key, insert the black key within 10 seconds and promptly turn it to "**ON**". After 1-3 seconds, turn the key to "**OFF**" again and pull it out. In this way, a maximum of 7 black keys can be programmed by repeating the above procedure keeping the indicated times.

## Final step - red key

After pulling out the last black key, insert the red key again and turn it to "ON" (this operation should be performed within 10 seconds of pulling out the previous key). Leave it in this position for 1 to 3 seconds and return it to the «OFF» position.

## Proper programming check

Insert the red key disabling the transponder (i.e., tilt the key cap by 90°) and turn the key to "ON". Perform the engine start-up operation. Ensure that the engine does not start. Insert the black key and repeat the start-up operation. Check that engine starts.

### WARNING

**SHOULD THE ENGINE START WITH THE RED KEY (WITH TRANSPONDER OFF), OR IN THE EVENT OF WRONG OPERATION DURING PROGRAMMING, REPEAT THE PROCEDURE FROM THE BEGINNING.**

## Accessing the fuel tank (01\_14, 01\_15)

Insert the key into the switch and press down until the glove box opens. In the event that the key switch is in «LOCK», turn the key to «OFF» or «ON» before pressing down. Press lever «B» and open the cover over the fuel tank cap «C».

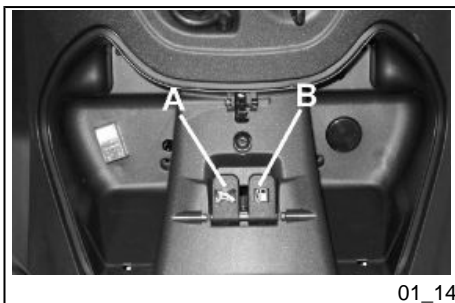

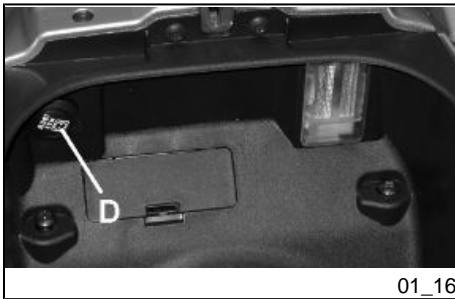

### Power supply socket (01\_16)

There is a plug socket "D" inside the helmet compartment.

The plug socket may be used for external consumers (mobile phone, inspection light, etc.).

#### CAUTION



**PROLONGED USE OF THE PLUG SOCKET MAY RESULT IN PARTIAL DISCHARGE OF THE BATTERY**

### Electric characteristic

#### Plug socket

12 V - 180 W MAX

#### Maximum power

180 W



## Identification (01\_17, 01\_18, 01\_19)

The identification numbers consist of a prefix stamped on the chassis «B» covered by port «A» and on the engine «C», followed by a number.

These numbers must always be mentioned on spare parts requests.

To read the chassis number, remove the relevant port «A» in the helmet compartment placed under the mat.

The chassis number stamped on the vehicle should be checked against that reported onto the vehicle's documents.

### CAUTION



**BE REMINDED THAT ALTERING IDENTIFICATION REGISTRATION NUMBERS CAN LEAD TO SERIOUS PENAL SANCTIONS (IMPOUNDING OF THE VEHICLE, ETC.).**

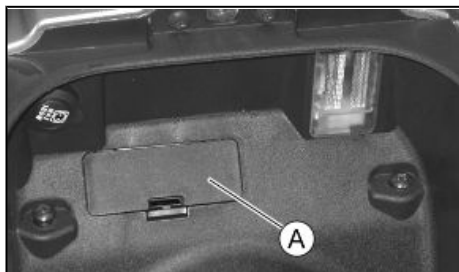

01\_17



01\_18

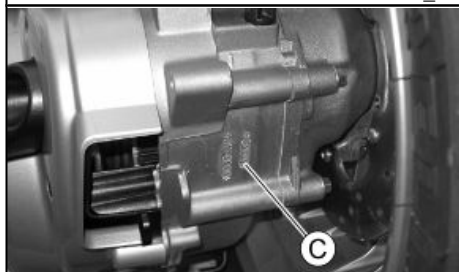

01\_19

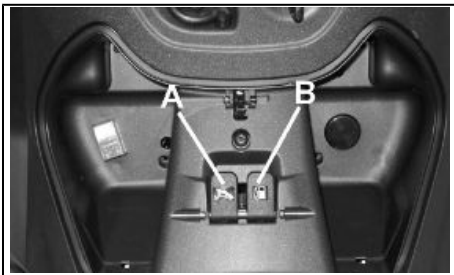

01\_20



01\_21

## Saddle opening button (01\_20, 01\_21)

With the key in position «OFF» or «ON» or with the engine on, you can electrically open the saddle by pressing button «E». If the electric opening does not work, use the emergency lever «A».

## Rear top box opening

Insert the key into the switch and press down until the glove compartment opens. In the event that the switch is in «LOCK», turn the key to «OFF» or «ON» before pressing it.

# Beverly 500



**PIAGGIO®**



**Chap. 02**  
**Use**

## Checks

Before using the vehicle, check:

1. There is enough fuel in the fuel tank.
2. Front and rear brake fluid level
3. That tyres are properly inflated.
4. The correct functioning of the tail lights, the headlight, and the turn indicators.
5. The correct functioning of front and rear brakes.
6. The oil level in the gearcase.
7. The engine oil level.
8. The coolant level

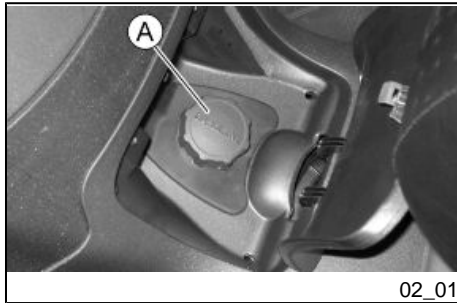

## Refuelling (02\_01, 02\_02)

**Fuel:** open the door as described in the section «Access to the gas tank» and turn the cap «A».

### Recommended fuel:

Minimum 95 octane unleaded gasoline.

The level of remaining fuel is indicated by the turning on of light «B»

### WARNING



**SWITCH OFF THE ENGINE BEFORE REFUELLING WITH PETROL.**

**PETROL IS HIGHLY INFLAMMABLE.**

**DO NOT SMOKE AND KEEP OPEN FLAMES AT A DISTANCE:FIRE HAZARD.**

**DO NOT INHALE FUEL FUMES.**



02\_02

**DO NOT ALLOW PETROL TO COME INTO CONTACT WITH HOT ENGINE OR ANY PLASTIC PARTS.**

**CAUTION**



**PETROL DAMAGES THE PLASTIC PARTS OF THE BODYWORK.**

**CAUTION**



**USING OILS OTHER THAN THOSE RECOMMENDED CAN SHORTEN THE LIFE OF THE ENGINE.**

**CAUTION**



**DO NOT USE THE VEHICLE TO THE COMPLETE EXHAUSTION OF THE FUEL; IN THE EVENT THAT THIS SHOULD OCCUR, DO NOT ATTEMPT TO START THE ENGINE. TURN THE KEY SWITCH TO OFF AND TOP-UP THE TANK AS SOON AS POSSIBLE. FAILURE TO FOLLOW THESE GUIDELINES COULD DAMAGE THE FUEL PUMP AND/OR THE CATALYTIC CONVERTER.**

**Characteristic**

**Fuel Tank Capacity**

13, 2 litres

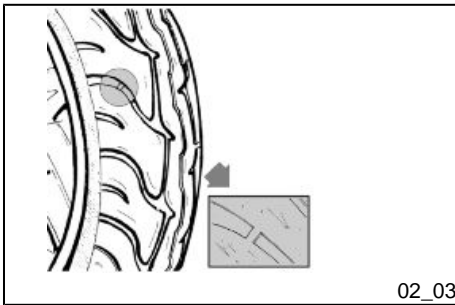

## Tyre pressure (02\_03)

Check periodically (about every 500 km) the pressure and wear of the tyres.

The tyres are equipped with wear indicators, according to which the tyres should be changed before these indicators come to the surface of the tread.

Check also that the tyres do not have tears on their sides or an irregular pattern of wear on the tread; if this occurs, go to an authorised workshop or at least equipped to perform the replacement.

### CAUTION



**TYRE PRESSURE SHOULD BE CHECKED WHEN TYRES ARE COLD. INCORRECT TYRE PRESSURE CAUSES ABNORMAL TYRE WEAR AND MAKES RIDING DANGEROUS.**

**TYRES MUST BE REPLACED WHEN THE TREAD REACHES THE WEAR LIMITS SET FORTH BY LAW.**

### Characteristic

#### Rear tyre pressure

2.2 bar with driver only

#### Rear tyre pressure

2.3 bar with passenger.



02\_04

## Shock absorbers adjustment (02\_04)

The preloading of the springs can be adjusted to 4 positions using the ring nut located in the lower part of the shock absorbers and the specific spanner supplied.

### Minimum preloading

Position 1: driver only

### Medium preloading

Position 2: driver and top-box

### Medium preloading

Position 3: rider and passenger

### Maximum preloading

Position 4: driver, passenger, and top-box.

The specific shock absorber wrench must be used to perform this operation. If there is too much resistance use the spark-plug wrench together with the shock absorber wrench.

### CAUTION



**RIDING THE VEHICLE WITH THE SPRING PRELOADING NOT CORRECTLY SET FOR THE RIDER AND POSSIBLE PASSENGER, COULD REDUCE THE COMFORT OF THE RIDE AND THE PRECISION OF THE STEERING.**

### WARNING



**WE RECOMMEND WEARING GLOVES WHILE CARRYING OUT THIS OPERATION IN ORDER TO AVOID INJURIES.**



02\_05

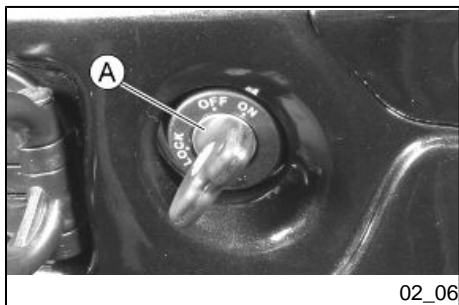

02\_06

**WARNING**

**WE STRONGLY RECOMMEND NOT TO ADJUST BOTH SHOCK ABSORBERS WITH DIFFERENT PRELOADING**

**Running in (02\_05)****WARNING**

**DURING THE FIRST 1000 KM DO NOT RIDE THE VEHICLE OVER 80% OF ITS MAXIMUM SPEED. AVOID TWISTING THE THROTTLE GRIP FULLY OR KEEPING A CONSTANT SPEED ALONG LONG SECTIONS OF ROAD. AFTER THE FIRST 1000 KM, GRADUALLY INCREASE SPEED UNTIL REACHING THE MAXIMUM PERFORMANCE.**

**Starting up the engine (02\_06, 02\_07)**

The vehicle is equipped with an ignition prevention system controlled by the side stand.

The engine cannot be started if the side stand is lowered.

If the engine is on, it will turn itself off if the side stand is lowered.

To start the engine it is necessary, before pressing the starter button, to pull and keep pulled the front or rear brake lever, which activates the appropriate switch allowing start-up.

1. Rest the vehicle on its centre-stand, ensuring the rear wheel is not touching the ground.
2. Keep the hand grip accelerator at the minimum.
3. Insert the key into the ignition switch «**A**» and turn to position «**ON**».



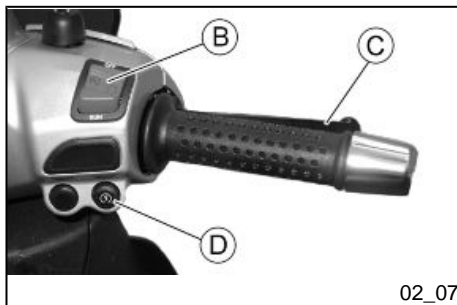

4. Make sure that the emergency stop switch «**B**» is in position «**RUN**» and the side stand is up and not engaged.

5. Pull lever «**C**» of the front or rear brake and then activate the starter button «**D**».

#### WARNING



**THE AUTOMATIC TRANSMISSION MAKES THE REAR WHEEL TURN EVEN WHEN THE THROTTLE IS SLIGHTLY TWISTED. RELEASE THE BRAKE CAREFULLY AFTER STARTING, AND THEN ACCELERATE GRADUALLY.**

#### CAUTION



**DO NOT START-UP THE ENGINE IN CLOSED AREAS BECAUSE EXHAUST GASES ARE TOXIC.**

#### Difficult start up

In the rare case of engine flooding, to facilitate start-up, it is possible to try to put the vehicle into action with the gas hand grip partially or completely open. It is however necessary, once the engine is started, to take your vehicle to an **Authorised Service Centre** to determine the cause of this problem and to re-establish the vehicle proper functioning.

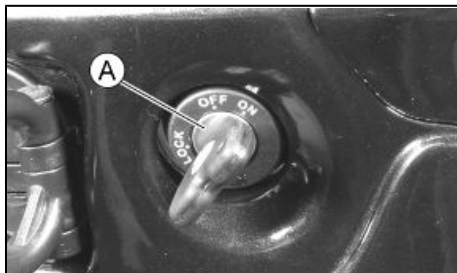

02\_08

## Stopping the engine (02\_08)

Fully untwist the throttle grip, then rotate the key in the switch «A » to «KEY OFF» (extractable key).



02\_09

## Stand (02\_09)

### Centre stand

Push with your foot on the centre stand's fork «F» while lifting the vehicle backward, holding onto the handlebar.

## Stand (02\_09, 02\_10)

### Side stand

Push with your foot on the stand's prong «L» until it releases into position, while lowering the vehicle onto the stand.

## WARNING



**THE SIDE STAND CAUSES THE ENGINE TO TURN ITSELF OFF WHENEVER IT IS LOWERED.**

## WARNING



**TAMPERING MAY CAUSE SERIOUS ENGINE MALFUNCTION.**

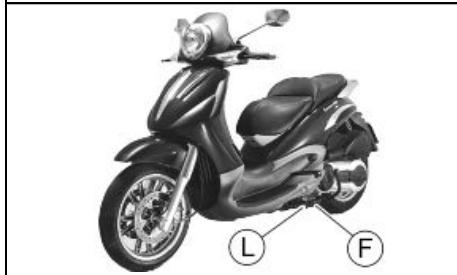

02\_10

## CAUTION



DUE TO THE HIGH TEMPERATURES THE CATALYTIC CONVERTER CAN REACH, ALWAYS TAKE CARE, WHEN PARKING THE SCOOTER, THAT THE EXHAUST DOES NOT COME INTO CONTACT WITH FLAMMABLE MATERIALS, TO AVOID SERIOUS BURNS.

## CAUTION



DO NOT SWITCH OFF THE ENGINE WHILE THE VEHICLE IS MOVING. UN-BURNED FUEL COULD ENTER THE CATALYTIC CONVERTER AND BURN, CAUSING IT TO OVERHEAT AND POSSIBLY DESTROYING IT.

### Automatic transmission (02\_11)

To ensure simple, pleasurable riding, the vehicle is equipped with automatic transmission with regulator and centrifugal clutch. The system is designed to provide the best performance (acceleration and consumption) while riding on both flat roads and uphill.

If you have to stop on an uphill slope (traffic lights, traffic jam, etc.) **use only the brake to keep the vehicle still, leaving the engine running at idle speed. Using the engine to keep the vehicle still can cause the clutch to overheat, due to the friction of the clutch mechanism itself against the clutch bell.**

It is therefore recommended to avoid conditions of prolonged clutch slippage (other than those previously indicated) like driving uphill fully laden on steep slopes or starting off with driver and passenger at slopes with steepness greater than 25%.

Observe the following precautions if the clutch overheats:

1. Do not continue riding in such conditions.
2. Let the clutch cool down with the engine at idle speed for a few minutes.



02\_11

## Safe driving

Some simple tips are provided below that will enable you to use your scooter on a daily basis in greater safety and peace of mind. Your skill and your mechanical knowledge are the basis of a safe ride. We recommend trying out the vehicle in traffic - free zones, in order to acquire a good knowledge of the vehicle it self.

1. Before riding off, remember to put on your helmet and fasten it correctly.
- 2.Reduce speed on rough roads and ride with care.
3. After riding on a long stretch of wet road without using the brakes, the braking effect is initially lower. In these conditions, it is a good idea to apply the brakes from time to time.
4. Do not brake hard on wet, unsurfaced or slippery road surfaces.
5. Avoid riding off by mounting the scooter when resting on the support. In any case, the rear wheel should not be turning when it comes into contact with the ground, in order to avoid abrupt departures.
6. If riding over roads affected by sand, mud, snow mixed with salt, etc. We advise you to frequently clean the brake disc with a mild detergent to prevent the accumulation of abrasive elements inside the eyelets leading to premature wear on the brake pads.

### CAUTION



**ALWAYS RIDE WITHIN YOUR LIMITS RIDING UNDER THE INFLUENCE OF ALCOHOL OR OTHER DRUGS AND CERTAIN MEDICATIONS IS EXTREMELY DANGEROUS.**

### CAUTION



**IN ORDER TO PREVENT ANY ACCIDENTS RIDE VERY CAREFULLY WHEN ADDING ACCESSORIES AND CARRYING LUGGAGE. THE ADDITION OF ACCESSORIES AND BAGGAGE CAN REDUCE THE STABILITY AND PERFORM-**

ANCE OF THE SCOOTER, AS WELL AS DECREASE THE LEVEL OF SAFETY DURING ITS USE. **NEVER RIDE THE SCOOTER WITH ADDED ACCESSORIES FASTER THAN 130 km/h.** WITHOUT THESE ACCESSORIES THE VEHICLE MAY BE DRIVEN AT A HIGHER SPEED WITHIN THE LEGAL LIMITS. IF THERE SHOULD BE NON-PIAGGO ACCESSORIES INSTALLED, OR AN ABNORMAL LOAD, OR IF THE SCOOTER IS NOT IN A GENERALLY GOOD CONDITION, OR WHENEVER WEATHER CONDITIONS DEMAND IT, SPEED SHOULD BE REDUCED FURTHER.

#### CAUTION



DO NOT ADJUST THE MIRRORS WHILE RIDING. THIS COULD CAUSE YOU TO LOOSE CONTROL OF THE VEHICLE.

#### CAUTION



ANY CHANGES TO THE VEHICLE PERFORMANCE AS WELL AS ALTERATIONS TO ORIGINAL STRUCTURAL PARTS IS STRICTLY FORBIDDEN BY LAW, AND RENDERS THE VEHICLE NO LONGER CONFORMING TO THE APPROVED TYPE AND DANGEROUS FOR RIDING.

### Accessories (02\_12, 02\_13)

The saddle is supplied with a protection cover. Lift the saddle and extract the cover from its housing to use it.

Fit it over the seat without pulling excessively to avoid tearing the material; lower the saddle.



02\_12



**CAUTION**



**DO NOT USE THE VEHICLE WITHOUT THE PROTECTION COVER.**

# Beverly 500



**PIAGGIO®**



**Chap. 03  
Maintenance**

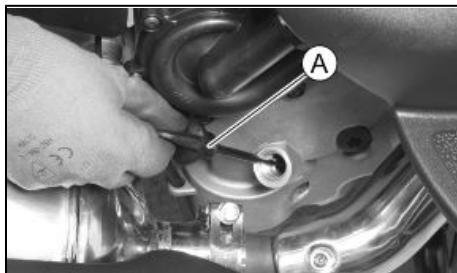

03\_01

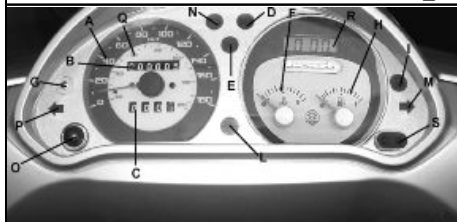

03\_02

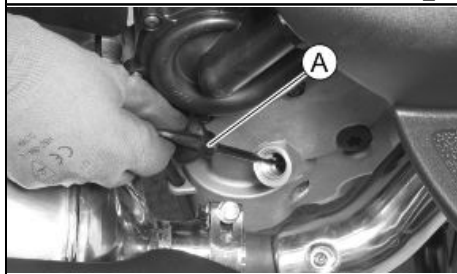

03\_03

## Engine oil level

In 4-stroke engines, engine oil is used to lubricate the distribution elements, the bushings and the thermal group. **An insufficient quantity of oil can cause serious damage to the engine.** In all four-stroke engines, a loss of efficiency in oil performance and consumption should be considered normal. Consumption can particularly reflect the conditions of use (i.e. when driving at "full acceleration" all the time, oil consumption increases). The replacement frequencies provided for by the maintenance programme are defined, depending on the total contents of oil in the engine and average consumption measured following standardised methods.

**In order to prevent any problems, we recommend checking oil level more frequently than indicated in the Scheduled Maintenance table or before setting off on long journeys. The scooter is, however, equipped with an oil pressure warning light on the instrument panel.**

## Engine oil level check (03\_01)

Every time the scooter is used, a visual check should be made on the level of the engine oil when the engine is cold. The oil level should be somewhere between the **MAX** and **MIN** index marks on the level bar; the check must be made with the scooter upright, resting on the centre stand and on a flat surface.

If the check is carried out after the vehicle has been used, and therefore with a hot engine, the level line will be lower; in order to carry out a correct check it is necessary to wait at least 10 minutes after the engine has been stopped, so as to get the correct level.

## Engine oil top-up

Always check the oil level before carrying out top ups in order **to avoid exceeding the MAX. level.** Getting an oil level between the **MIN** and **MAX** index marks requires ~ 400 cc of oil. An oil check-up and top-up should be carried out every 3000 Km by authorised personnel at any **Authorised Piaggio-Gilera Service Centre.**

## Warning light (insufficient oil pressure) (03\_02)

The scooter is equipped with a warning light "D" that lights up when the key is turned to the "ON" position.



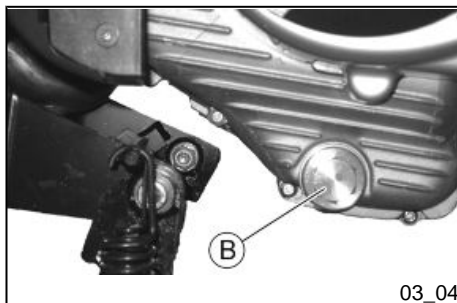

This light should, however, go out once the engine has been started.

**If the light comes on during braking, at idling speed or while turning a corner, it is necessary to check the oil level and top up if required. If, after having topped up the oil, the warning light persists in coming on while braking, at idling speed or while turning a corner, it will be necessary to turn to an Authorised Piaggio service centre.**

### Engine oil change (03\_03, 03\_04)

The engine oil and filter must be replaced every 6,000 km by an **authorised Piaggio service centre**. The engine should be emptied by draining the oil via the drainage cap "B" of the gauze filter on the transmission side. In order to facilitate the oil drainage, loosen the cap/dipstick "A". Since a certain quantity of oil still remains in the circuit, filling must be done with engine oil via cap "A". Then start the scooter, allow it to run for a few minutes and then switch it off: after five minutes, check the level and if necessary top up **without exceeding the MAX. level**. The cartridge filter must be replaced at every oil change. For top up and change, use new oil of the recommended type.

#### CAUTION



**RUNNING THE ENGINE WITH INSUFFICIENT LUBRICATION OR WITH INADEQUATE LUBRICANTS ACCELERATES THE WEAR AND TEAR OF THE MOVING PARTS AND CAN CAUSE IRRETRIEVABLE DAMAGE.**

**TOPPING UP THE ENGINE WITH AN EXCESSIVE AMOUNT OF OIL MAY CAUSE MALFUNCTION AND/OR A DROP IN PERFORMANCE OF THE VEHICLE.**

**USING OILS OTHER THAN THOSE RECOMMENDED CAN SHORTEN THE LIFE OF THE ENGINE.**

#### WARNING



**EXCESSIVE OIL LEVEL AT TOP-UPS CAN LEAD TO SCALE FORMATION AND VEHICLE MALFUNCTIONING.**

**CAUTION**

**USED OILS CONTAIN SUBSTANCES HARMFUL TO THE ENVIRONMENT. FOR OIL REPLACEMENT, CONTACT AN AUTHORISED SERVICE CENTRE, WHICH IS EQUIPPED TO DISPOSE OF USED OILS IN AN ENVIRONMENTALLY FRIENDLY AND LEGAL WAY.**

**Recommended products****AGIP CITY HI TEC 4T**

*Engine oil*

SAE 5W-40, API SL, ACEA A3, JASO MA Synthetic oil

**Characteristic****Engine oil (at oil and filter change)**

1.5 lt.

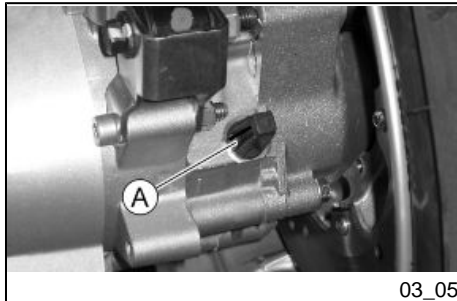

03\_05

**Hub oil level (03\_05)**

Check the oil in the rear hub.

To check the rear hub oil level, proceed as follows:

1. Park the scooter on level ground and rest it on its centre stand.
2. Unscrew the oil dipstick «A», dry it with a clean cloth. Reinsert it and **screw it tightly into place**.
3. Pull out the dipstick and check that the oil level is between the MIN and MAX reference marks. If the oil level is below the MIN notch, top up with the required amount of hub oil.
4. Screw the dipstick back in, checking that it is locked in place.

The notches on the hub oil level dipstick, apart from that indicating the **MAX** level, refer to other models from the manufacturer and have no specific function for this model.

**CAUTION**

**RIDING THE VEHICLE WITH INSUFFICIENT HUB LUBRICATION OR WITH CONTAMINATED OR IMPROPER LUBRICANTS ACCELERATES THE WEAR AND TEAR OF THE MOVING PARTS AND CAN CAUSE SERIOUS DAMAGE.**

**CAUTION**

**USED OIL CAN HARM THE ENVIRONMENT. COLLECTION AND DISPOSAL SHOULD BE CARRIED OUT IN COMPLIANCE WITH CURRENT REGULATIONS.**

**CAUTION**

**AN EXCESSIVE QUANTITY OF OIL CAN LEAD TO LEAKAGE, WHICH MAY CAUSE THE ENGINE AND THE WHEEL TO GET DIRTY.**

**CAUTION**

**UPON REPLACING HUB OIL, AVOID THE OIL COMING INTO CONTACT WITH THE REAR BRAKE DISC.**

**CAUTION**

**FOR OIL REPLACEMENT, CONTACT ANY AUTHORISED SERVICE CENTRE AS THEY ARE EQUIPPED TO DISPOSE OF USED OILS IN AN ENVIRONMENTALLY FRIENDLY AND LEGAL WAY.**

**Recommended products****AGIP ROTRA 80W-90***Rear hub oil*

SAE 80W/90 Oil that exceeds the requirements of API GL3 specifications

**Characteristic****Quantity:**

approx. 250 cc

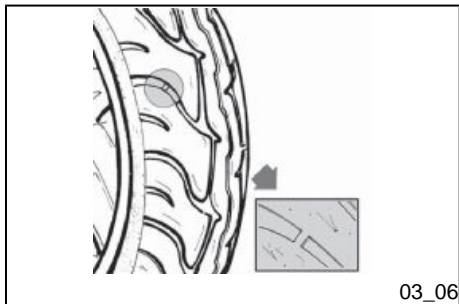

03\_06

**Tyres (03\_06)**

Check periodically (roughly every 500 km) the tyre pressure. The tyres are equipped with wear indicators; the tyres must be changed as soon as these indicators become visible on the surface. Also check that the tyres do not show signs of splitting at the side or irregular tread wear; should this occur, take your vehicle to an authorised workshop or a workshop equipped for replacement.

**CAUTION**

**TYRE PRESSURE SHOULD BE CHECKED WHEN TYRES ARE COLD. INCORRECT TYRE PRESSURE CAUSES ABNORMAL TYRE WEAR AND MAKES RIDING DANGEROUS.**

**TYRES MUST BE REPLACED WHEN THE TREAD REACHES THE WEAR LIMITS SET FORTH BY LAW.**

**CAUTION**



**IT IS MANDATORY TO ADOPT EXCLUSIVELY "S" CLASS TYRES, WHICH GUARANTEE CORRECT VEHICLE PERFORMANCE AT THE DIFFERENT SCOOTER SPEEDS. USING ANY OTHER TYRE MAY RESULT IN VEHICLE INSTABILITY. IT IS ADVISABLE TO USE TYRE TYPES RECOMMENDED BY PIAGGIO.**

**Characteristic**

**Front tyre pressure**

2.2 bar

**Rear tyre pressure**

2.2 bar with driver only

**Rear tyre pressure**

2.3 bar with passenger.

**FRONT TYRE**

Front tyre

Pirelli 110/70 16" GTS 23 M/C -  
52S TUBELESS

## REAR TYRE

Rear tyre

Pirelli 150/70 14" GTS 24 M/C -  
66S TUBELESS

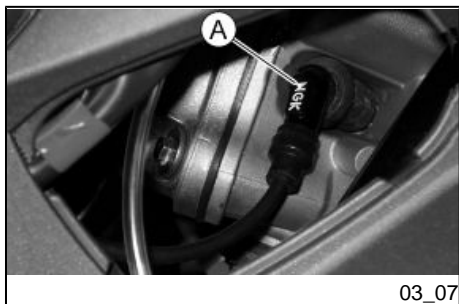

### Spark plug dismantlement (03\_07)

Proceed as follows:

1. remove the spark plug access port located on the left side of the vehicle and access the spark plug by inserting your hand;
2. disconnect the cap «A» of the spark plug HV wire;
3. unscrew the spark plug, using the spanners supplied;
4. upon re-assembly, insert the spark plug at the correct angle, screwing it in tightly by hand;
5. only use the spanner supplied for the final tightening work;
6. insert the cap «A» over the spark plug.

#### CAUTION



**THE SPARK PLUG MUST BE REMOVED WHEN THE ENGINE IS COLD. THE SPARK PLUG SHOULD BE CHECKED EVERY 6,000 KM AND REPLACED EVERY 12,000 KM. THE USE OF NON-CONFORMING IGNITION CONTROL UNITS AND SPARK PLUGS OTHER THAN THOSE PRESCRIBED CAN SERIOUSLY DAMAGE THE ENGINE**

.

#### N.B.

**THE USE OF SPARK PLUGS OTHER THAN THE INDICATED TYPE OR OF SHIELDLESS SPARK PLUG CAPS CAN CAUSE ELECTRICAL SYSTEM FAILURES.**

## Characteristic

### Spark plug

- NGK CR7EKB
- Champion RG6YC

### Electrode gap

0.7-0.8 mm

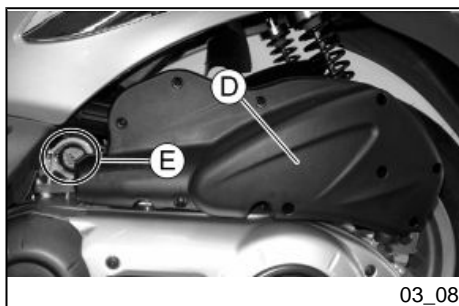

03\_08

## Removing the air filter (03\_08)

Proceed as follows:

- Loosen the clamping screws and remove the air filter cover "D";
- Remove the filter element and clean it with water and shampoo; then dry it with a clean cloth and slight blows of compressed air. Finally, immerse it in a mixture containing 50% oil of the recommended type and 50% petrol.

Then gently squeeze the filter element between your hands, allow it to drip and then refit it.

### CAUTION



**IF THE VEHICLE IS USED ON DUSTY ROADS IT IS NECESSARY TO CARRY OUT MAINTENANCE CONTROLS OF THE AIR FILTER TO AVOID DAMAGING THE ENGINE.**

### CAUTION



**IN ORDER NOT TO DAMAGE THE VEHICLE PLASTIC COVERS CONTACT AN AUTHORISED SERVICE CENTRE TO HAVE THE AIR FILTER CLEANED.**

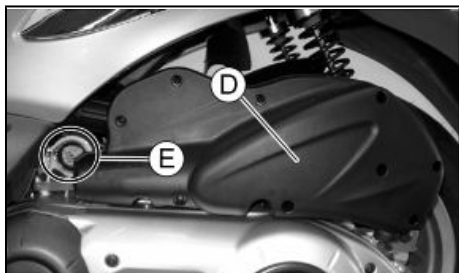

03\_09



03\_10

## Recommended products

### AGIP FILTER OIL

*Oil for air filter sponge*

Mineral oil with specific additives for increased adhesiveness

### Air filter cleaning (03\_09, 03\_10)

Periodically check the exhaust blow-by and condensate pipe in area "E" and empty it into a suitable container.

Position the scooter on the centre stand and remove cover "F", without removing any other components, working from underneath the scooter and noting that it is located behind the shoulder of the transmission air intake.

Collect the old oil in a suitable container and do not dispose of it in the environment. Carry out the operation on the cold engine in order to avoid burns caused by coming into contact with the engine.

### CAUTION



**USED OILS CONTAIN SUBSTANCES HARMFUL TO THE ENVIRONMENT. FOR OIL REPLACEMENT, CONTACT AN AUTHORISED SERVICE CENTRE, WHICH IS EQUIPPED TO DISPOSE OF USED OILS IN AN ENVIRONMENTALLY FRIENDLY AND LEGAL WAY.**



## Cooling fluid level (03\_11, 03\_12, 03\_13)

The engine cooling system is of the forced liquid circulation type. The coolant circuit contains approx. 1.7 litres of coolant consisting of a mixture of 50% demineralised water and glycol ethylene-based antifreeze solution with corrosion inhibitors.

The liquid supplied with the scooter is already mixed and ready for use.

For proper functioning of the engine, ensure that the temperature of the coolant remains in the middle zone of gauge "C" on the instrument panel. If the needle of the gauge enters the red zone, switch off the engine, allow to cool down and check the coolant level; if this is not within the prescribed limit, contact an **authorised Piaggio service centre**.

The fluid level must be checked every 6,000 kilometres with a cold engine, in the way shown below:

- a) Place the scooter in a vertical position on the stand.
- b) Loosen clamping screw "A" and remove the cover.
- c) Remove the expansion tank cover "B", turning in anticlockwise direction.
- d) Look inside the expansion tank; a scale in the plastic indicates the maximum and minimum level of the coolant.
- e) Top up, if necessary, if the fluid level is below the MIN level on the scale inside the expansion tank.

The fluid level must always be between MIN and MAX level

If the fluid is near the minimum level, proceed with the top-up operation to be carried out when the engine is cold. If it is necessary to top up the coolant frequently or if the expansion tank is completely empty, the cause has to be found in the cooling system.

It is then essential to have the cooling system inspected by an **authorised Piaggio service centre**.

The coolant should be changed every 2 years.

For this operation, please contact an **authorised Piaggio service centre**.



03\_11

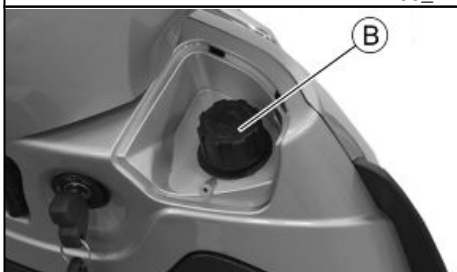

03\_12



03\_13

**N.B.**

**IF DURING A NON-DEMANDING RIDE THE COOLANT WARNING LIGHT COMES ON, SHUT OFF THE ENGINE AND ALLOW IT TO COOL DOWN. THEN CHECK THE COOLANT LEVEL; IF THE LEVEL IS NOT CORRECT, CONTACT AN AUTHORISED SERVICE CENTRE.**

**WARNING**

**TO AVOID THE RISK OF SCALDING, DO NOT UNSCREW THE EXPANSION TANK COVER WHILE THE ENGINE IS STILL HOT.**

**WARNING**

**TO PREVENT AVOID HARMFUL FLUID LEAKAGE WHILE RIDING, ENSURE THAT THE LEVEL NEVER EXCEEDS THE MAXIMUM VALUE.**

**TO ENSURE CORRECT ENGINE OPERATION, KEEP THE RADIATOR GRILLE CLEAN.**

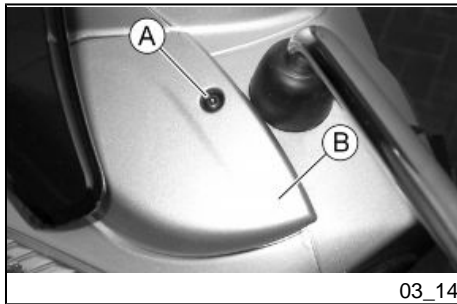
**Checking the brake oil level (03\_14, 03\_15)**

The brake fluid tanks are located on the pumps under the front handlebar cover (front on the right-hand side, rear on the left-hand side).

The procedures to checking the brake fluid level for the front and rear brakes are identical.

Proceed as follows:

1. Place the scooter on its centre stand and make sure the handlebar is centred;
2. Loosen screw "A" and remove cover "B";
3. Check the fluid level through the respective sight glass "C". A certain lowering of the level is caused by wear on the pads.

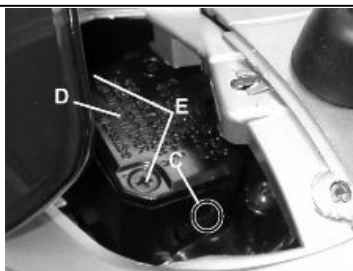

03\_15

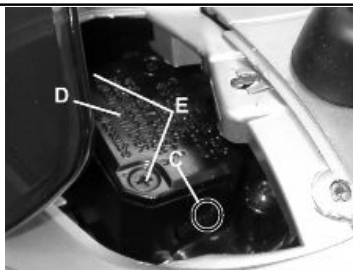

03\_16

Should the level appear to be below the minimum mark, please contact your nearest **PIAGGIO dealer or authorised service centre** in order to have a thorough inspection of the brake system carried out.

### Braking system fluid top up (03\_16)

Proceed as follows:

Remove tank cover "D" and loosen the two screws "E" and top up the brake fluid level using only the prescribed brake fluid and without exceeding the maximum level.

Under normal climatic conditions, the brake fluid should be replaced every 2 years.

This operation must be carried out by trained technicians; please contact your nearest **PIAGGIO dealer or an authorised service centre**.

#### WARNING

**BRAKE CIRCUIT FLUID IS VERY CORROSIVE; DO NOT LET IT COME INTO CONTACT WITH PAINTED PARTS.**

#### CAUTION

**ONLY USE DOT 4-CLASSIFIED BRAKE FLUID.**

#### WARNING

**THE BRAKE FLUID IS HAZARDOUS: IN CASE OF ACCIDENTAL CONTACT, WASH OFF WITH WATER.**

#### WARNING

**THE BRAKING CIRCUIT LIQUID IS HYGROSCOPIC, AND ABSORBS THE HUMIDITY OF SURROUNDING AIR. IF THE HUMIDITY IN THE BRAKING FLUID EXCEEDS A CERTAIN VALUE, IT WILL LEAD TO INEFFICIENT BRAKING. NEVER USE BRAKING FLUID KEPT IN CONTAINERS THAT HAVE ALREADY BEEN OPENED, OR PARTIALLY USED.**

### Recommended products

**AGIP BRAKE 4**

*Brake fluid*

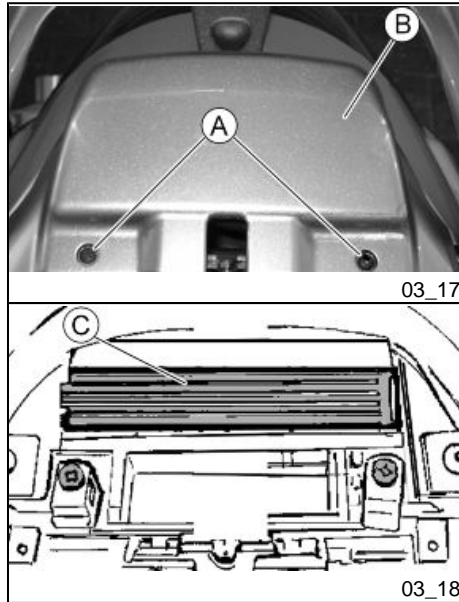

FMVSS DOT 4 Synthetic fluid

## Battery (03\_17, 03\_18)

In order to gain access to the battery, proceed as follows:

1. rest the vehicle on the central stand;
2. open the saddle as described above.
3. remove the fasteners «A» and the small cover «B».
4. release the elastic band «C».

The battery is the electric device that requires the most assiduous surveillance and the most diligent maintenance.

The main maintenance regulations to be carried out are as follows:

### WARNING



**DO NOT DISCONNECT THE BATTERY CABLES WITH THE ENGINE RUNNING, THIS CAN CAUSE PERMANENT DAMAGE TO THE VEHICLE ELECTRONIC CONTROL UNIT.**

### WARNING

**THE ELECTROLYTE CONTAINS SULPHURIC ACID: AVOID CONTACT WITH EYES, SKIN AND CLOTHES. IN THE CASE OF ACCIDENTAL CONTACT, RINSE WITH ABUNDANT OF WATER AND CONSULT A DOCTOR.**

### WARNING



**USED BATTERIES ARE HARMFUL FOR THE ENVIRONMENT. COLLECTION AND DISPOSAL SHOULD BE CARRIED OUT IN COMPLIANCE WITH CURRENT REGULATIONS.**

## Electric characteristic

### Battery

12V - 14 Ah

### Use of a new battery

Ensure that the terminals are connected correctly and check the voltage.

#### CAUTION



**DO NOT REVERSE THE POLARITY: RISK OF SHORT CIRCUIT AND DAMAGE TO THE ELECTRICAL SYSTEM.**

### Checking the electrolyte level

The electrolyte level, which should be checked regularly, must always be at the maximum level. To top it up to this level, **use only distilled water**.

Should it become necessary to top up the battery with water too frequently, check the scooter's electrical system because the battery is being overloaded, causing it to lose power quickly.

### Long periods of inactivity

Battery performance will decrease if the vehicle is not used for a long time. This is the result of the natural phenomenon of battery discharging plus residual absorption by vehicle components with constant power consumption. Poor battery performance may also be due to environmental conditions and the cleanness of the poles. In order to avoid difficult starts and/or irreversible damage to the battery, follow any of these steps:

- **At least once a month** start the engine and run it slightly above idle speed for 10-15 minutes. This keeps all the engine components, as well as the battery, in good working order.

- Take your vehicle to a garage (as indicated in the "Vehicle not used for extended periods" section) to have the battery removed. Have the battery cleaned, charged fully and stored in a dry, ventilated place. Recharge **at least once every two months**.

#### CAUTION

**THE BATTERY MUST BE RECHARGED WITH A CURRENT LOAD EQUAL TO 1/10 OF THE BATTERY RATED CAPACITY AND FOR A PERIOD NOT LONGER THAN 8 HOURS. TAKE THE VEHICLE TO AN AUTHORISED PIAGGIO SERVICE CENTRE FOR THIS OPERATION. WHEN REFITTING THE BATTERY MAKE SURE THE LEADS ARE CORRECTLY CONNECTED TO THE TERMINALS.**

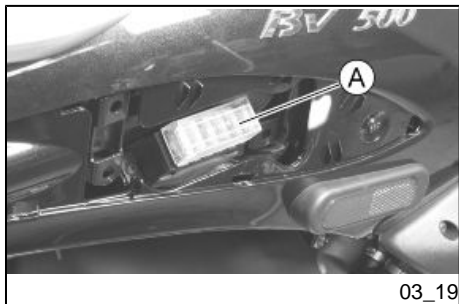

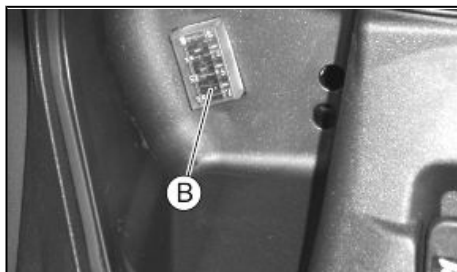

03\_20

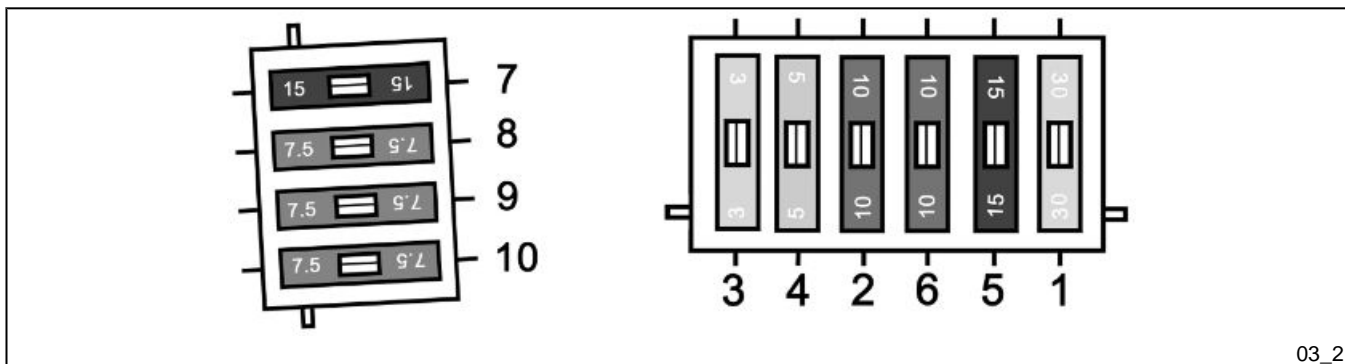

03\_21

### Fuses (03\_19, 03\_20, 03\_21)

The electrical system is equipped with:

1. Six protective fuses «A» located inside the side panel on the right-hand side;
2. Four protective fuses «B» located inside the compartment on the upper left-hand side.

The chart shows the position and characteristics of the fuses in the vehicle.

**CAUTION**

**BEFORE REPLACING A BLOWN FUSE, FIND AND SOLVE THE FAILURE THAT CAUSED IT TO BLOW. NEVER TRY TO REPLACE THE FUSE WITH ANY OTHER MATERIAL (E.G., A PIECE OF ELECTRIC WIRE).**

**CAUTION**

**MODIFICATIONS OR REPAIRS TO THE ELECTRICAL SYSTEM, PERFORMED INCORRECTLY OR WITHOUT STRICT ATTENTION TO THE TECHNICAL SPECIFICATIONS OF THE SYSTEM, CAN CAUSE ERRORS IN FUNCTIONING AND RISK OF FIRE.**

**FUSES**

General	<b>Position on fuse box:</b> 1 <b>Fuse:</b> 30A <b>Protected circuits:</b> General
Electronic control unit remote control switch	<b>Position on fuse box:</b> 2 <b>Fuse:</b> 10A <b>Protected circuits:</b> Electronic control unit remote control switch
Controller power supply, immobilizer	<b>Terminal box arrangement:</b> 3 <b>Fuse:</b> 3 A



	<b>Protected circuits:</b> Controller power supply, immobilizer
Control unit live	<b>Position on fuse box:</b> 4 <b>Fuse:</b> 5A <b>Protected circuits:</b> Control unit live
Outlet 12V-180W, button for helmet compartment lighting, bulb for helmet compartment lighting, contacts for key switch, actuator for seat opening, electrical button opening	<b>Position on fuse box:</b> 5 <b>Fuse:</b> 15A <b>Protected circuits:</b> Outlet 12V-180W, button for helmet compartment lighting, bulb for helmet compartment lighting, contacts for key switch, actuator for saddle opening, electrical button opening
Light remote control	<b>Position on fuse box:</b> 6 <b>Fuse:</b> 10A <b>Protected circuits:</b> Light remote control
Light flash, fitting for accessories, horn	<b>Position on fuse box:</b> 7 <b>Fuse:</b> 15A <b>Protected circuits:</b> Light flash, fitting for accessories, horn
Stop lights, preparation for radio and anti-theft device, damper, instrument panel live	<b>Position on fuse box:</b> 8 <b>Fuse:</b> 7.5A

**Protected circuits:** Stop lights, preparation for radio and anti-theft device, damper, instrument panel live

---

Light switch, front and rear light bulbs, license plate bulb, instrument panel lighting

**Position on fuse box:** 9

**Fuse:** 7.5A

**Protected circuits:** Light switch, front and rear light bulbs, license plate bulb, instrument panel lighting

---

Immobilizer LED, radio/intercom fitting, anti-theft system

**Position on fuse box:** 10

**Fuse:** 7.5A

**Protected circuits:** Immobilizer LED, radio/intercom fitting, anti-theft system

---

### **LIST OF BULBS**

---

High-/low-beam bulb

**Type:** Halogen (H4)

**Quantity:** 1

**Power:** 12V - 55/60W

---

Front tail light bulb

**Type:** All glass

**Quantity:** 1

**Power:** 12V - 5W

---

Turn indicator bulbs	<b>Type:</b> Spherical <b>Quantity:</b> 4 <b>Power:</b> 12V - 10W
Rear tail light bulb	<b>Type:</b> All glass <b>Quantity:</b> 2 <b>Power:</b> 12V - 3W
Stop light bulb	<b>Type:</b> Spherical <b>Quantity:</b> 1 <b>Power:</b> 12V - 10W
Instrument panel lighting bulb	<b>Type:</b> All glass <b>Quantity:</b> 2 <b>Power:</b> 12V - 2W
Helmet compartment light bulb	<b>Type:</b> Cylindrical <b>Quantity:</b> 1 <b>Power:</b> 12V - 5W
License plate light bulb	<b>Type:</b> All glass <b>Quantity:</b> 1 <b>Power:</b> 12V - 5W

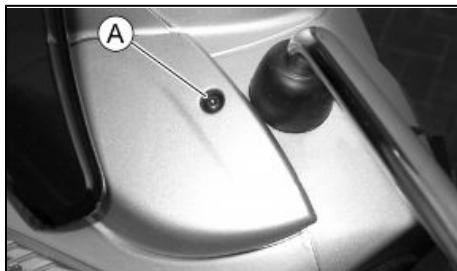

03\_22

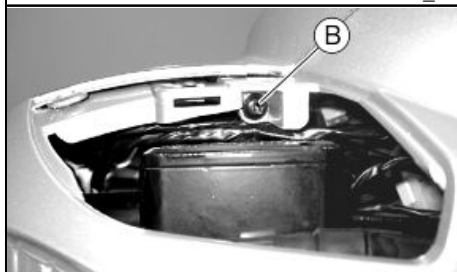

03\_23

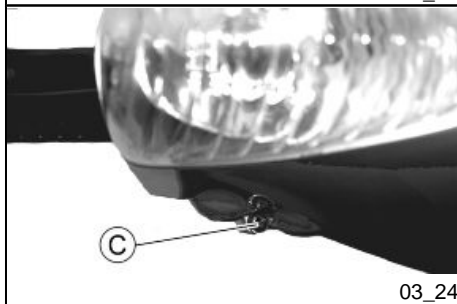

03\_24

## Front light group (03\_22, 03\_23, 03\_24, 03\_25, 03\_26)

To remove the front headlight assembly, proceed as follows:

1. Remove screws «A» of the brake fluid tank cover.
2. Remove the 3 windshield screws and the windshield proper.
3. Remove the rear-view mirrors.
4. Remove the screws "C" of the upper coupling.
5. Remove the screws "C" of the lower coupling.
6. Remove the two screws "D" of the front handlebar cover.
7. Remove the front handlebar cover.

This gives access to the bulbs.

Release the spring and take out the bulb of the high-beam/low-beam headlamp «E».

To replace the tail light «F», pull out the rubber bulb holder from its seat.

To reassemble, repeat the operation in the reverse order.

### WARNING



**THE TWIN-FILAMENT (HIGH-BEAM AND LOW-BEAM) BULB IS HALOGEN: DO NOT TOUCH THE BULB WITH YOUR FINGERS TO AVOID COMPROMISING ITS FUNCTIONING**

## Headlight adjustment (03\_27, 03\_28)

Proceed as follows:

1. Place the vehicle in running order and with the tyres inflated to the prescribed pressure, on a flat surface 10 m away from a white screen situated in a shaded area, making sure that the longitudinal axis of the vehicle is perpendicular to the screen;



03\_25

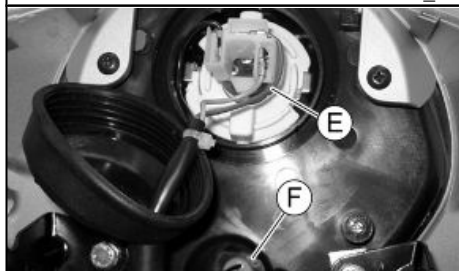

03\_26



03\_27

2. Turn on the headlight and check that the borderline of the projected light beam on the screen is not higher than 9/10 or lower than 7/10 of the distance from the ground to the centre of vehicle headlamp;

3. If this is not the case, regulate the headlight by turning screw «A».

**N.B.**

**THE ABOVE PROCEDURE COMPLIES WITH THE EUROPEAN STANDARDS REGARDING MAXIMUM AND MINIMUM HEIGHT OF LIGHT BEAMS. REFER TO THE STATUTORY REGULATIONS IN FORCE IN EVERY COUNTRY WHERE THE vehicle IS USED.**

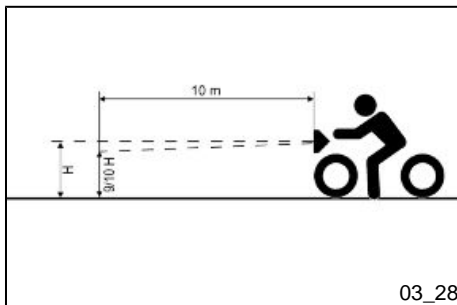

03\_28



03\_29

### Front direction indicators (03\_29)

To replace the burnt bulb, remove the screws «G»

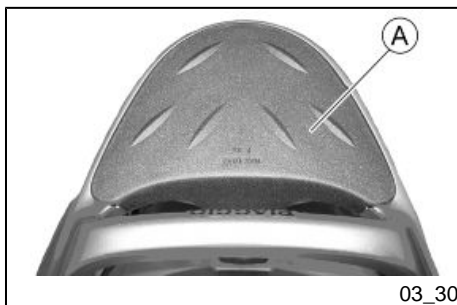

03\_30

### Rear optical unit (03\_30, 03\_31, 03\_32, 03\_33, 03\_34)

To remove the rear light assembly, proceed as follows:

1. Remove the plastic cover "A" from the rear luggage rack, then remove the two lateral screws of the lower part of the luggage rack proper.
2. Remove screw "B"
3. Remove screws "C" and the lateral panels of the side, paying attention not to damage the retaining straps.
4. Remove the two screws "D" of the light assembly being tested and remove it.

You thus gain access to the rear light bulb "E", the stop light bulb "F" and turn indicator bulbs "G".

Release the spring and take out the bulbs.

To replace the rear light bulbs "E", pull out the rubber lamp holder from its seat.

To reassemble, repeat the operation in the reverse order.

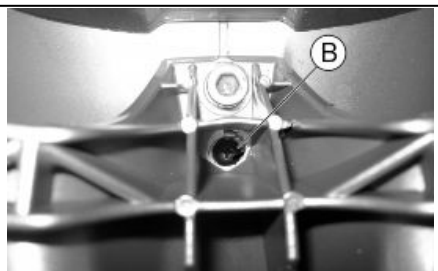

03\_31



03\_32

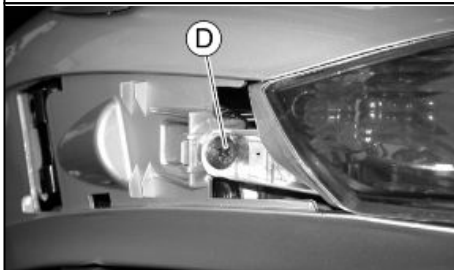

03\_33

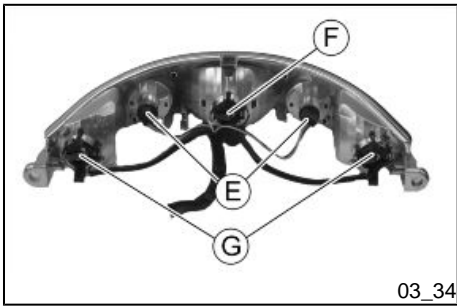

### **Number plate light**

Remove the support of the license plate light by loosening its retaining screw. Take out the rubber lamp holder and then take out the bulb.

### **Helmet compartment lighting bulb**

Open the helmet compartment, take out the snap-on transparent glass and replace the bulb.

### **Rear-view mirrors**

Adjust the mirrors by applying slight pressure to the side of the mirror to move it to the desired position.



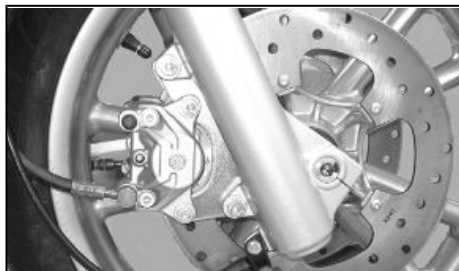

03\_35

### Front and rear disc brake (03\_35)

The brake disc and pad wear is automatically compensated, therefore it has no effect on the functioning of the front and rear brakes. For this reason it is not necessary to adjust the brakes. An excessively elastic brake lever stroke may indicate the presence of air in the braking circuit or a failure in the braking system. In this case, mainly due to the importance of brakes to guarantee safe riding conditions, the vehicle should be taken to an **Authorised Service Centre or Dealer**.

#### CAUTION



**THE BRAKING ACTION SHOULD BEGIN AFTER ABOUT 1/3 OF THE BRAKE LEVER STROKE.**

#### CAUTION



**HAVE THE BRAKE PADS CHECKED BY THE DEALER ACCORDING TO THE CHECKS SPECIFIED IN THE SCHEDULED MAINTENANCE TABLE. HOWEVER, IN THE EVENT OF NOISES COMING FROM THE FRONT AND/OR REAR BRAKE SYSTEM DURING OPERATION, IT IS ADVISABLE TO HAVE THE BRAKE SYSTEM CHECKED BY A PIAGGIO DEALER OR AUTHORISED SERVICE CENTRE. AFTER REPLACING THE BRAKE PADS, DO NOT USE THE SCOOTER BEFORE HAVING USED THE BRAKE LEVER SEVERAL TIMES IN ORDER TO ALLOW THE PISTONS TO SETTLE AND THE LEVER STROKE TO BE SET TO THE CORRECT POSITION.**

#### CAUTION



**THE PRESENCE OF SAND, MUD, SNOW MIXED WITH SALT, ETC. ON THE ROAD, CAN DRASTICALLY REDUCE THE DURATION OF THE BRAKE PADS. IN**

**ORDER TO AVOID THIS, WE RECOMMEND WASHING THE VEHICLE FREQUENTLY WHEN RIDING IN THESE ROAD CONDITIONS.**

## **Puncture**

The vehicle is equipped with Tubeless tyres (without inner tube). In the event of a puncture, contrary to the situation with a tyre with inner tube, the tyre deflates more slowly, resulting in a greater steering safety. In the event of a puncture, it is admissible to make an emergency repair using an "inflate and repair" spray can. For a final repair, take your vehicle to an **Authorised Service Centre or Dealer**. The replacement of a tyre involves removing the wheel in question. Take your vehicle to an **Authorised Service Centre or Dealer** for these operations.

### **CAUTION**



**TO USE THE "INFLATE AND REPAIR" SPRAY PROPERLY FOLLOW THE INSTRUCTIONS ON THE PACKAGING.**

### **WARNING**



**THE WHEELS FITTED WITH TYRES SHOULD ALWAYS BE BALANCED. RIDING THE VEHICLE WITH VERY LOW TYRE PRESSURE OR WITH INCORRECTLY BALANCED TYRES CAN LEAD TO DANGEROUS STEERING VIBRATIONS.**



03\_36

## Periods of inactivity (03\_36)

We recommend carrying out the following operations:

1. Clean the scooter thoroughly and then cover it with a canvas;
2. With the engine off and the piston in the bottom dead centre position, remove the spark plug, and pour into its hole 1 to 2 cc of the recommended oil. Operate the starter button 1-2 times for roughly 1 second to turn the engine over slowly, then insert the spark plug again;
3. Ensure that the **fuel tank is at least half full (in order to ensure the total immersion of the fuel pump)**; spread antirust grease on the unpainted metal parts; keep the wheels lifted above the ground by resting the chassis on two wooden wedges;
4. As regards the battery, follow the instructions in the "Battery" section.

## Recommended products

### AGIP CITY HI TEC 4T

*Oil to lubricate flexible transmissions (throttle control)*

Oil for 4-stroke engines

## Cleaning the vehicle

In order to soften the dirt and mud deposited on the painted surfaces, use a low pressure jet of water. Once softened, mud and dirt must be removed with a soft sponge for bodywork soaked in lots of water and "shampoo" (2-4% of car shampoo in water). Then rinse abundantly with water, and dry with a shammy cloth. Any polishing with silicon wax must always be preceded by washing

### CAUTION



**DETERGENTS CAN POLLUTE WATER. THE VEHICLE MUST BE WASHED AT A WASH STATION EQUIPPED WITH A SPECIAL WATER PURIFICATION SYSTEM.**

**WARNING**

**THE USE OF A HIGH-PRESSURE WATER JET IS STRONGLY DISCOURAGED FOR ANY ENGINE CLEANING OPERATION; HOWEVER, IF NO OTHER MEANS ARE AVAILABLE, IT IS THEN NECESSARY TO:**

- **ONLY USE THE FAN JET.**
- **DO NOT PLACE THE NOZZLE CLOSER THAN 60 CM.**
- **DO NOT USE WATER AT TEMPERATURES OVER 40°C.**
- **DO NOT USE HIGH-PRESSURE WATER JETS.**
- **DO NOT STEAM WASH.**
- **DO NOT DIRECT THE JET AT: THE CARBURETTOR, THE ELECTRIC CABLES, THE SLOT DIFFUSERS IN THE TRANSMISSION COVER AND THE SCROLL COVER.**

**CAUTION**

**NEVER WASH THE SCOOTER IN DIRECT SUNLIGHT, ESPECIALLY IN SUMMER WHEN THE BODYWORK IS STILL HOT AS THE SHAMPOO COULD DAMAGE THE PAINTWORK IF IT DRIES BEFORE BEING RINSED OFF. NEVER USE CLOTHS SOAKED IN ALCOHOL, PETROL, DIESEL OIL OR KEROSENE FOR CLEANING THE PAINTED OR PLASTIC SURFACES, IN ORDER NOT TO DAMAGE THE LUSTRE FINISH OR ALTER THE MECHANICAL PROPERTIES. USING SILICONE-BASED WAX CAN DAMAGE THE PAINTED SURFACES, DEPENDING ON THE VEHICLE COLOUR (SATIN COLOURS). FOR FURTHER INFORMATION ON THIS MATTER, CONTACT AN AUTHORISED SERVICE CENTRE .**



IN ORDER TO MAINTAIN PROPER CLEANING AND BRILLIANCE OF THE MUFFLER, WE RECOMMEND THE USE OF A PRODUCT SPECIFICALLY FOR CHROME-PLATED SURFACES

PIAGGIO RECOMMENDS AND DISTRIBUTES A PASTE SPECIALLY FOR THE GLOSS OF STAINLESS STEEL MUFFLERS; IT CAN BE ORDERED UNDER THE NUMBER 602683M FROM THE DEALER NETWORK.

### STARTING FAILURE

Emergency switch in «OFF»	Set the switch back to « <b>ON</b> »
Fuse blown	Replace the blown fuse and have the vehicle checked by an <b>Authorised Service Centre</b> .

### STARTING DIFFICULTIES (SEE SECTION "DIFFICULT STARTING")

Lack of fuel in tank.	Refuelling
Injection system fault	Contact an <b>Authorised Service Centre</b>
Faulty fuel pump	Contact an <b>Authorised Service Centre</b>
Battery flat	Recharge the battery.

**\* IMPORTANT: DO NOT USE THE SCOOTER TO THE COMPLETE EXHAUSTION OF THE FUEL; IN THE EVENT THAT THIS SHOULD OCCUR, DO NOT ATTEMPT TO START THE ENGINE. TURN THE KEY SWITCH TO "OFF" AND TOP-UP THE TANK AS SOON AS POSSIBLE. THE FAILURE TO FOLLOW THESE GUIDELINES COULD CAUSE DAMAGE TO THE FUEL PUMP AND/OR THE CATALYTIC CONVERTER.**

### **IGNITION PROBLEM**

Faulty spark plug	Contact an <b>Authorised Service Centre.</b>
Faulty ignition / injection control unit. Due to the presence of high voltage, this check should only be carried out by an expert.	Contact an <b>Authorised Service Centre</b>

### **LACK OF COMPRESSION**

Loosen spark plug.	Screw in the spark plug tightly
Cylinder head loose, piston gas rings worn.	Contact an <b>Authorised Service Centre.</b>
Valve stuck	Contact an <b>Authorised Service Centre.</b>

### **HIGH CONSUMPTION AND LOW PERFORMANCE**

Clogged or dirty air filter	Try to blow out with compressed air, otherwise replace the filter
-----------------------------	---

### **INSUFFICIENT BRAKING**

Greasy disc. Worn pads. Faulty braking system. Presence of air in the front and rear brake circuit. Contact an **Authorised Service Centre**.

### **INEFFICIENT SUSPENSIONS**

Shock absorber fault, oil leak, end buffer damaged; shock absorber preloading incorrectly set. Contact an **Authorised Service Centre**.

### **IRREGULAR AUTOMATIC TRANSMISSION**

Variator rollers and/or driving belt damaged. Contact an **Authorised Service Centre**.





# Beverly 500



**PIAGGIO®**



**Chap. 04**  
**Technical data**

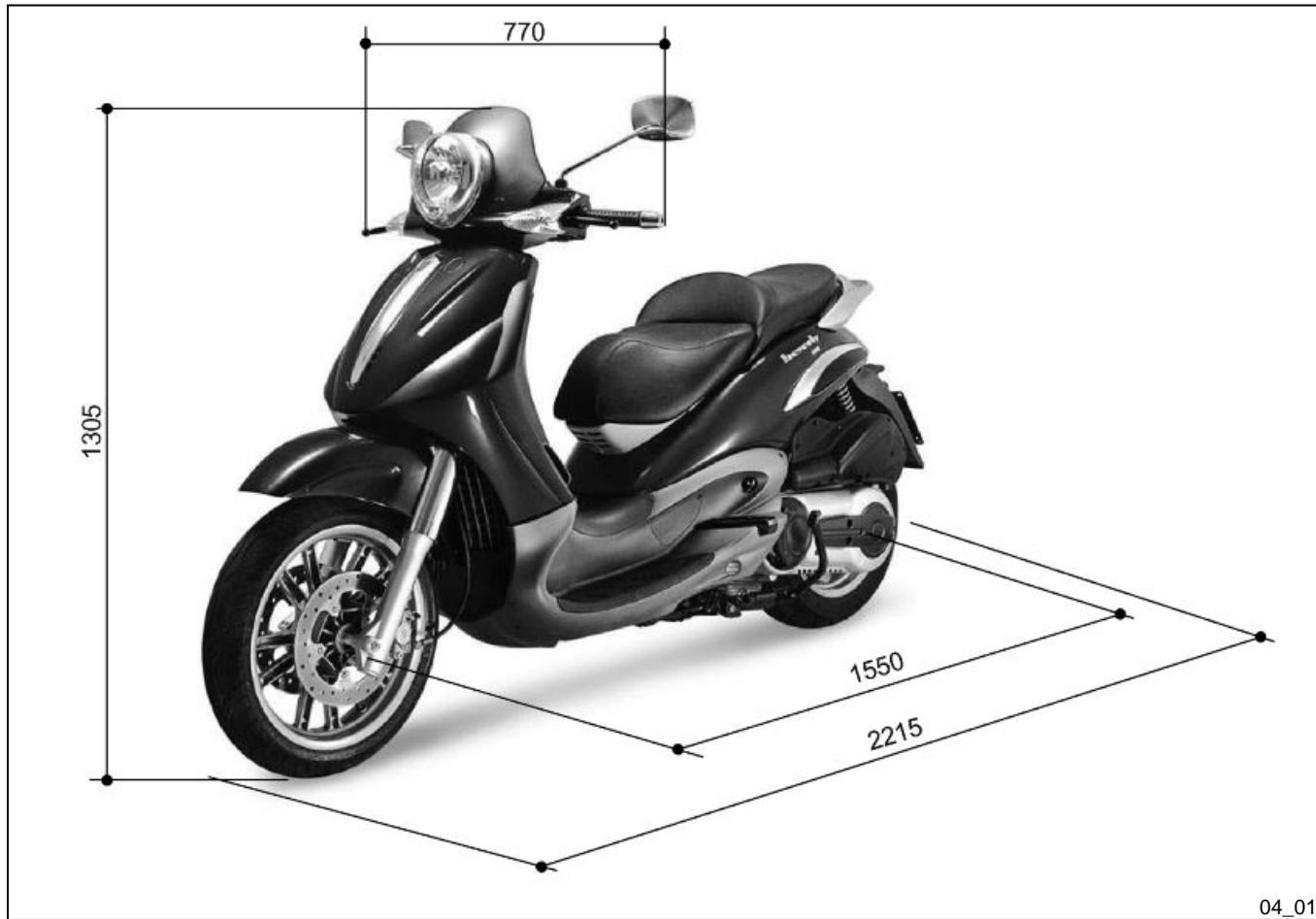

**DATA**

Version	500
Engine	Single-cylinder, four-stroke, four valves, single overhead camshaft, chain driven on the flywheel side
Bore x stroke	92 X 69 mm
Cubic capacity	460 cm <sup>3</sup>
Compression ratio	10.5: 1
Ignition advance (before TDC)	Variable advance controlled by the injection control unit
Fuel supply	38 Ø mm throttle body and single injector
Spark plug	<ul style="list-style-type: none"> <li>• NGK CR7EKB</li> <li>• Champion RG6YC</li> </ul>
Max. speed	160 km/h
Valve clearance	intake: 0.15 mm discharge (when cold): 0.15 mm (when cold)
RPM	1500 ± 50 revs/min

**TECHNICAL DATA**

Overall width	770 mm
Overall length	2215 mm
Overall height	1305 mm
Wheel base	1550 mm

Fuel supply	Electronic injection with electric fuel pump.
Exhaust muffler	absorption-type exhaust muffler with catalytic converter.
Electronic ignition	inductive, high efficiency integrated with the injection system, with variable timing and separate HV coil.
Lubrication	Engine lubrication with trochoidal pump (inside the crankcase), oil filter and pressure adjustment by-pass.
Cooling	Forced fluid circulation, with engine driven pump; 3-way thermostat to pump intake.
Transmission	Automatic expandable pulley variator, trapezoidal belt, dry automatic centrifugal clutch, gear reducer and transmission compartment with forced circulation.
Front brake	Ø 260 (vehicle RH side), with hydraulic command activated from handlebars with right-hand lever.
Combined brake	with dual disc brake, Ø 260 front (vehicle LH side) and Ø 240 rear, with hydraulic command activated from handlebars with lefthand lever. The system is provided with a pressure divider valve.
Front wheel	16"x3.00" front alloy rim
Rear wheel	14"x4.50" alloy rim

Front tyre	Pirelli 110/70 16" GTS 23 M/C - 52S TUBELESS
Rear tyre	Pirelli 150/70 14" GTS 24 M/C - 66S TUBELESS
Front suspension	Hydraulic telescopic fork with stem diameter 41 mm.
Rear suspension	engine in relation to the rocker forks with two double-acting hydraulic shock absorbers and setting of the preload in 4 positions.
Chassis	Tubular and steel sheets.
Empty weight	193 Kg
Maximum load	Maximum load 189 Kg.
Fuel tank capacity	~13,2 l (approximate value)
Reserve	approx. 3 litres (approximate value)
Engine oil (empty)	1.7 lt.
Engine oil (at oil and filter change)	1.5 lt.
Rear oil hub	Capacity: ~250 cc
Cooling system	Capacity: approx. 1.7 l

### Kit equipment

One box-spanner; one lever for box-spanner; one twin screwdriver; one special wrench for adjusting rear shock absorbers. The tools are stored in the helmet compartment.



# Beverly 500



**PIAGGIO®**



**Chap. 05**  
**Spare parts and**  
**accessories**



05\_01

## Warnings (05\_01)

### WARNING



IT IS ALSO RECOMMENDED THAT "ORIGINAL PIAGGIO SPARE PARTS" BE USED, AS THESE ARE THE ONLY ONES OFFERING YOU THE SAME QUALITY GUARANTEE AS THOSE INITIALLY FITTED ON THE SCOOTER. THE USE OF NON-ORIGINAL SPARE PARTS RENDERS THE WARRANTY VOID.

### WARNING



PIAGGIO MARKETS ITS OWN LINE OF ACCESSORIES THAT ARE RECOGNISED AND GUARANTEED FOR USE. IT IS THEREFORE ESSENTIAL, IN ORDER TO CHOOSE AND MOUNT THE ACCESSORIES CORRECTLY, TO CONTACT AN AUTHORISED DEALER OR SERVICE CENTRE. THE USE OF NON-ORIGINAL ACCESSORIES MAY AFFECT THE STABILITY AND OPERATION OF YOUR VEHICLE AND REDUCE SAFETY LEVELS WITH POTENTIAL RISKS FOR THE RIDER.

### WARNING



TO PREVENT ACCIDENTS AND TO GUARANTEE PROPER STABILITY, PERFORMANCE AND SAFETY, RIDE THE VEHICLE VERY CAREFULLY WHEN IT IS FITTED WITH ACCESSORIES OR WITH UNUSUAL LOADS.

### WARNING



IN ORDER TO PREVENT ANY ACCIDENTS RIDE VERY CAREFULLY WHEN ADDING ACCESSORIES AND CARRYING LUGGAGE. ADDING ACCESSORIES AND BAGGAGE CAN REDUCE YOUR SCOOTER STABILITY AND PERFORM-



ANCE, AS WELL AS DECREASE THE LEVEL OF SAFETY DURING USE. NEVER RIDE THE SCOOTER WITH ADDED ACCESSORIES FASTER THAN 130 Km/h. THIS MAXIMUM SPEED LIMIT CAN BE FURTHER REDUCED DUE TO THE USE OF NON-PIAGGIO ACCESSORIES, AN ABNORMAL LOAD, WORN TYRES, AND SCOOTER, STREET AND WEATHER GENERAL CONDITIONS.



# Beverly 500



**PIAGGIO®**



**Chap. 06  
Programmed  
maintenance**

## Scheduled maintenance table

Adequate maintenance is fundamental to ensure long-lasting, optimum operation and performance of your vehicle.

To this end, a series of checks and maintenance operations (at the owner's expense) have been suggested, which are included in the summary table on the following page. Any minor faults should be reported without delay to an **Authorised Service Centre or Dealer** without waiting until the next scheduled service to solve it.

All scheduled maintenance services must be carried out at the specified intervals, even if the stated mileage has not yet been reached. Punctual scooter servicing is essential to ensure your warranty remains valid. For any further information concerning Warranty procedures and "Scheduled Maintenance", please refer to the "Warranty Booklet".

### **EVERY 2 YEARS**

---

Coolant - change

---

Brake fluid - change

---

### **EVERY 3,000 KM**

---

Engine oil - level check/ top-up

---

Brake pads - check condition and wear

---

### **AFTER 1,000 KM OR 4 MONTHS**

---

Engine oil - replacement

---

Hub oil - change

---

Carburetion - check/adjust

Seals/injection system hoses - visual check

Base vent - check

Steering - adjustment

Brake control levers - greasing

Brake fluid level - check

Safety locks - check

Electrical system and battery - check

Vehicle and brake test - test ride

### **AT 6,000 KM OR 12 MONTHS**

Engine oil - replacement

Hub oil - level check

Spark plug / electrode gap - check

Air filter - clean

Engine oil - change

Valve clearance - check

Base vent - check

Variable speed rollers - replacement

Driving belt - checking

Coolant level - check

Brake fluid level - check

Electrical system and battery - check

Tyre inflation and wear - Check

Electro-hydraulic stand control joint - Check

Stand roller - Check

Vehicle and brake test - test ride

### **AT 12000 KM OR 24 MONTHS AND 60000 KM**

Engine oil - replacement

Hub oil - level check

Spark plug / electrode gap - replacement

Air filter - clean

Engine oil - change

Carburetion - check/adjust

Seals/injection system hoses - visual check

Base vent - check

Variable speed rollers - replacement

Roller support sliding blocks - check/change

Driving belt - replacement

Coolant level - check

Steering - adjustment

Brake control levers - greasing

Brake fluid level - check

---

Safety locks - check

---

Suspensions - check

---

Electrical system and battery - check

---

Headlight - adjustment

---

Tyre inflation and wear - Check

---

Electro-hydraulic stand control joint - Grease

---

Stand control roller - replace

---

Vehicle and brake test - test ride

---

### **AT 18,000 KM AND 54,000 KM**

---

Engine oil - replacement

---

Hub oil - level check

---

Spark plug / electrode gap - check

---

Air filter - change

---

Engine oil - change

---

Valve clearance - check

---

Base vent - check

---

Variable speed rollers - replacement

---

Driving belt - checking

---

Coolant level - check

---

Radiator - external cleaning/ check

---

Brake fluid level - check

---

Electrical system and battery - check

Tyre inflation and wear - Check

Electro-hydraulic stand control joint - Grease

Stand roller - Check

Vehicle and brake test - test ride

### **AT 24000 KM**

Engine oil - replacement

Hub oil - change

Spark plug / electrode gap - replacement

Air filter - clean

Engine oil - change

Fuel filter - check

Carburetion - check/adjust

Seals/injection system hoses - visual check

Base vent - check

Variable speed rollers - replacement

Roller support sliding blocks - check/change

Driven pulley bushing - check / grease

Driving belt - replacement

Coolant level - check

Steering - adjustment



---

Brake control levers - greasing

---

Brake fluid level - check

---

Safety locks - check

---

Suspensions - check

---

Electrical system and battery - check

---

Headlight - adjustment

---

Tyre inflation and wear - Check

---

Electro-hydraulic stand control joint - Grease

---

Stand control roller - replace

---

Vehicle and brake test - test ride

---

### **AT 30,000 KM, 42,000 KM AND 66,000 KM**

---

Engine oil - replacement

---

Hub oil - level check

---

Spark plug / electrode gap - check

---

Air filter - clean

---

Engine oil - change

---

Base vent - check

---

Variable speed rollers - replacement

---

Driving belt - checking

---

Coolant level - check

---

Brake fluid level - check

---

Electrical system and battery - check

Tyre inflation and wear - Check

Electro-hydraulic stand control joint - Check

Stand roller - Check

Vehicle and brake test - test ride

### **AT 36,000 KM**

Engine oil - replacement

Hub oil - level check

Spark plug / electrode gap - replacement

Air filter - change

Engine oil - change

Valve clearance - check

Carburetion - check/adjust

Seals/injection system hoses - visual check

Base vent - check

Variable speed rollers - replacement

Roller support sliding blocks - check/change

Driving belt - replacement

Coolant level - check

Radiator - external cleaning/ check

Steering - adjustment

---

Brake control levers - greasing

---

Flexible brake tubes - replacement

---

Brake fluid level - check

---

Safety locks - check

---

Suspensions - check

---

Electrical system and battery - check

---

Headlight - adjustment

---

Tyre inflation and wear - Check

---

Electro-hydraulic stand control joint - Grease

---

Stand control roller - replace

---

Vehicle and brake test - test ride

---

### **AT 48000 KM**

---

Engine oil - replacement

---

Hub oil - level check

---

Spark plug / electrode gap - replacement

---

Air filter - clean

---

Engine oil - change

---

Fuel filter - replacement

---

Carburetion - check/adjust

---

Seals/injection system hoses - visual check

---

Base vent - check

---

---

Variable speed rollers - replacement

---

Roller support sliding blocks - check/change

---

Driven pulley bushing - check / grease

---

Driving belt - replacement

---

Coolant level - check

---

Steering - adjustment

---

Brake control levers - greasing

---

Brake fluid level - check

---

Safety locks - check

---

Suspensions - check

---

Electrical system and battery - check

---

Headlight - adjustment

---

Tyre inflation and wear - Check

---

Electro-hydraulic stand control joint - Grease

---

Stand control roller - replace

---

Vehicle and brake test - test ride

---

### **AT 72,000 KM**

---

Engine oil - replacement

---

Hub oil - change

---

Spark plug / electrode gap - check / replacement

---

Air filter - change

---

Engine oil - change
Fuel filter - check
Valve clearance - check
Carburetion - check/adjust
Seals/injection system hoses - visual check
Base vent - check
Variable speed rollers - replacement
Roller support sliding blocks - check/change
Driven pulley bushing - check / grease
Driving belt - replacement
Coolant level - check
Radiator - external cleaning/ check
Steering - adjustment
Brake control levers - greasing
Flexible brake tubes - replacement
Brake fluid level - check
Safety locks - check
Suspensions - check
Electrical system and battery - check
Headlight - adjustment
Tyre inflation and wear - Check
Electro-hydraulic stand control joint - Grease
Stand control roller - replace

### **RECOMMENDED PRODUCTS TABLE**

<b>Product</b>	<b>Description</b>	<b>Specifications</b>
AGIP ROTRA 80W-90	Rear hub oil	SAE 80W/90 Oil that exceeds the requirements of API GL3 specifications
AGIP GP 330	Grease for brake control levers, throttle, stand	White calcium complex soap-based spray grease with NLGI 2; ISO-L-XBCIB2
AGIP CITY HI TEC 4T	Oil to lubricate flexible transmissions (throttle control)	Oil for 4-stroke engines
AGIP BRAKE 4	Brake fluid	FMVSS DOT 4 Synthetic fluid
SPECIAL AGIP PERMANENT	coolant	Monoethylene glycol-based antifreeze fluid, CUNA NC 956-16
AGIP FILTER OIL	Oil for air filter sponge	Mineral oil with specific additives for increased adhesiveness
AUTOSOL METAL POLISH	Muffler cleaning paste	Specific product for cleaning and polishing stainless steel mufflers.
AGIP CITY HI TEC 4T	Engine oil	SAE 5W-40, API SL, ACEA A3, JASO MA Synthetic oil
AGIP GREASE SM 2	Grease for the tone wheel revolving ring	Soap-based lithium grease containing NLGI 2 Molybdenum disulphide; ISO-L-XBCHB2, DIN KF2K-20
AGIP GREASE PV2	Grease for the steering bearings, pin seats and swinging arm	White anhydrous-calcium based grease to protect roller bearings; temperature range between -20 C and +120 C; NLGI 2; ISO-L-XBCIB2.

# TABLE OF CONTENTS

## **A**

Air filter: 39, 40

## **B**

Battery: 44, 45

Brake: 42, 57

## **C**

Clock: 9

## **D**

Disc brake: 57

## **E**

Engine oil: 32, 33

Engine stop: 12

## **F**

Fuel: 15

Fuses: 47

## **H**

Headlight: 52

Horn: 11

Hub oil: 34

## **I**

Identification: 17

Immobilizer: 12, 14

Instrument panel: 8

## **K**

Key switch: 10

Keys: 12

## **L**

Light switch: 11

## **M**

Maintenance: 31, 75, 76

Mirrors: 56

## **S**

Saddle: 18

Scheduled maintenance: 76

Shock absorbers: 23

Spark plug: 38

Stand: 26

Start-up: 11

## **T**

Tank: 15

Technical Data: 65

Top box: 18

Transmission: 27

Tyre pressure: 22

Tyres: 36



The descriptions and illustrations given in this publication are not binding. While the basic specifications as described and illustrated in this booklet remain unchanged, PIAGGIO-GILERA reserves the right, at any time and without being required to update this publication beforehand, to make any changes to components, parts or accessories, which it considers necessary to improve the product or which are required for manufacturing or construction reasons.

Not all versions shown in this publication are available in all countries. The availability of single versions should be checked at the official Piaggio sales network.

"© Copyright 2007 - PIAGGIO & C. S.p.A. Pontedera. All rights reserved. Reproduction of this publication in whole or in part is prohibited."

PIAGGIO & C. S.p.A. - After-Sales

V.le Rinaldo Piaggio, 23 - 56025 PONTEDERA (Pi)