

PIAGGIO WOULD LIKE TO THANK YOU

for choosing one of its products. We have prepared this manual to help you to get the very best from your vehicle. Please read it carefully before riding the vehicle for the first time. It contains information, tips and precautions for using your vehicle. It also describes features, details and devices to assure you that you have made the right choice. We believe that if you follow our suggestions, you will soon get to know your new scooter and it will serve you well for a long time to come. This booklet forms an integral part of the vehicle; should the vehicle be sold, it must be transferred to the new owner.

BEVERLY Cruiser 250ie



The instructions given in this manual are intended to provide a clear, simple guide to using your vehicle; this booklet also details routine maintenance procedures and regular checks that should be carried out on the vehicle at an **authorised Dealer or Service Centre**. The booklet also contains instructions for simple repairs. Any operations not specifically described in this booklet require the use of special tools and/or particular technical knowledge: to carry out these operations, refer to any **authorised Dealer or Service Centres**.



Personal safety

Failure to completely observe these instructions will result in serious risk of personal injury.



Safeguarding the environment

Sections marked with this symbol indicate the correct use of the vehicle to prevent damaging the environment.



Vehicle intactness

The incomplete or non-observance of these regulations leads to the risk of serious damage to the vehicle and sometimes even the invalidity of the guarantee.

The signs that you see on this page are very important. They are used to highlight parts of the booklet that should be read with particular care. The different symbols are used to make each topic in the manual simple and quick to locate.

INDEX

VEHICLE..... 7

- Dashboard..... 9
- Analogueinstrumentpanel..... 11
- Keyswitch..... 11
 - Lockingthesteeringwheel..... 12
 - Releasingthesteeringwheel..... 12
- Switchdirectionindicators..... 13
- Hornbutton..... 13
- Lightswitch..... 14
- Start-upbutton..... 14
- Enginestopbutton..... 15
- Theimmobilizersystem..... 15
 - Keys..... 16
 - Immobilizerdeviceenabledindicatorled..... 17
 - Operation..... 17
 - Programmingtheimmobilizersystem..... 18
- Accessingthefueltank..... 20
- Powersupplysocket..... 20
- Thesaddle..... 21
 - Openingthesaddle..... 23
- Identification..... 23
- Rearboxopening..... 24
- Bagclip..... 25

USE..... 27

- Checks..... 28
- Refuelling..... 28
- Tyrepressure..... 30
- Shockabsorbersadjustment..... 31
- Runningin..... 32
- Startinguptheengine..... 32
 - Precautions..... 33
- Difficultstartup..... 34
- Stoppingtheengine..... 34

- Stand..... 35
- Automatictransmission..... 36
- Safedriving..... 37

MAINTENANCE..... 39

- Engineoillevel..... 40
 - Engineoillevelcheck..... 40
 - Engineoiltop-up..... 41
 - Warninglight(insufficientoilpressure)..... 41
 - Engineoilchange..... 41
- Hufoillevel..... 43
- Tyres..... 45
- Sparkplugdismantlement..... 46
- Removingtheairfilter..... 47
- Airfiltercleaning..... 48
- Coolingfluidlevel..... 49
- Checkingthebrakeoillevel..... 50
 - Brakingsystemfluidtopup..... 51
- Battery..... 52
 - Useofanewbattery..... 53
- Long periods of inactivity..... 54
- Fuses..... 54
- Frontlightgroup..... 59
 - Headlightadjustment..... 60
- Frontdirectionindicators..... 61
- Rearopticalunit..... 62
- Numberplatelight..... 64
- Helmetcompartmentlightingbulb..... 65
- Rear-viewmirrors..... 65
- Frontandrear-discbrake..... 66
- Puncture..... 67
 - delveicolo..... 68
 - Cleaningthevehicle..... 68

TECHNICALDATA..... 73

Toolkit.....	78
SPAREPARTSANDACCESSORIES.....	79
Warnings.....	80
SCHEDULEDMAINTENANCE.....	83
Scheduledservicingtable.....	84

BEVERLY Cruiser 250ie



PIAGGIO®



**Chap. 01
Vehicle**

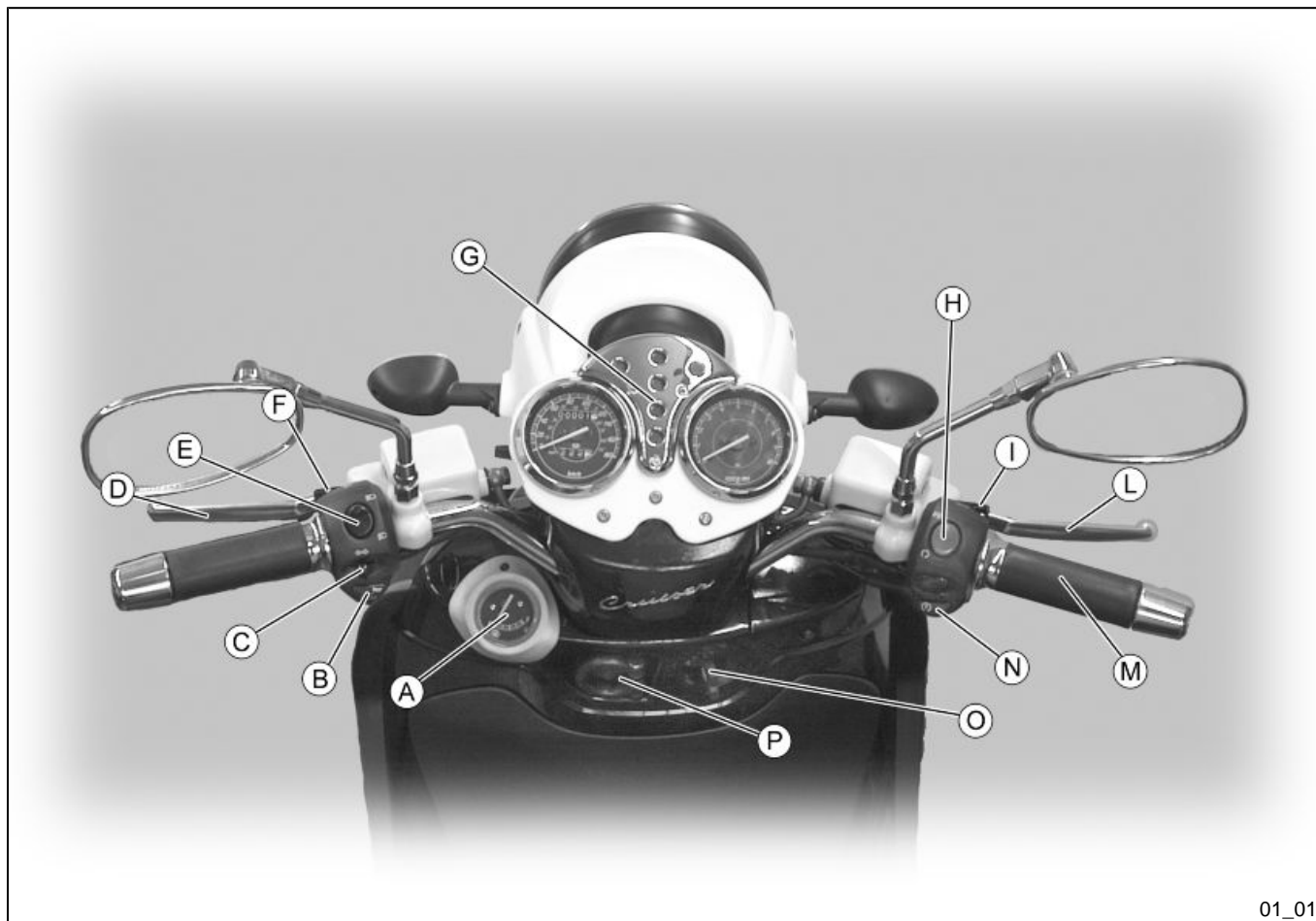

Dashboard (01_01)

A = Fuel gauge

B = Horn button

C = Turn indicator switch

D = Rear brake lever

E = Light switch

F = PASSING button

G = Instrument panel

H = Engine stop switch

I = Saddle electric opening switch

L = Front brake lever

M = Throttle grip

N = Starter button

O = Ignition key switch

P = Bag hook

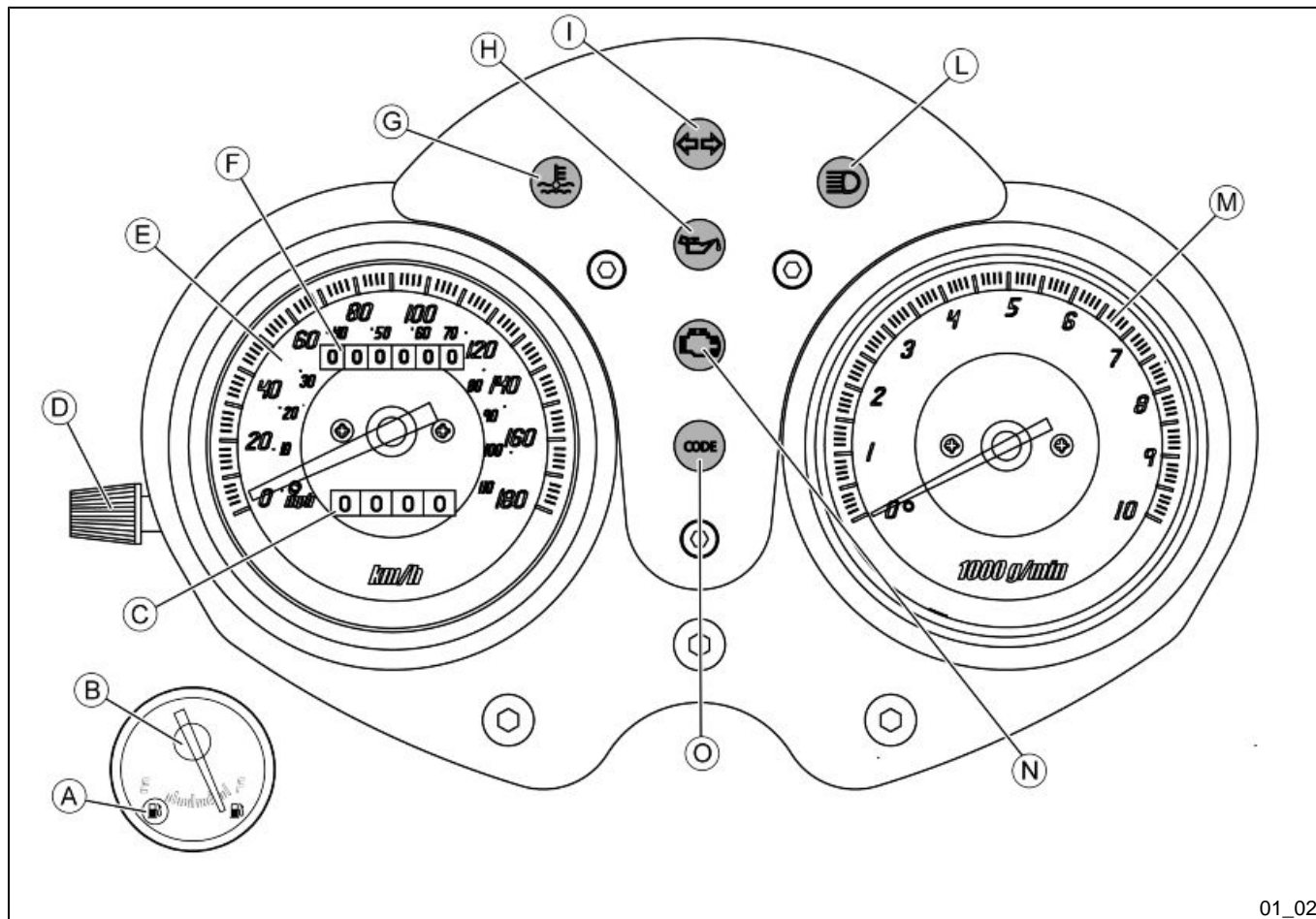

Analogueinstrumentpanel (01_02)

A = Low fuel warning light

B = Fuel gauge

C = Trip odometer

D = Trip odometer reset

E = Speedometer

F = Total Odometer

G = Water temperature warning light

H = Oil pressure warning light

I = Turn indicator warning light

L = High-beam warning light

M = Rpm indicator

N = Injection telltale light

O = Immobilizer LED

Keyswitch (01_03)

Ignition key «**A**» is located on the front leg shield back plate near the bag hook.

SWITCH POSITIONS

ON«1»: Ready to start position, non-extractable key, mechanical antitheft device disabled.

OFF «2»: Ignition disabled, extractable key, mechanical antitheft device disabled.

LOCK «3»: Ignition disabled, extractable key, mechanical antitheft device enabled.

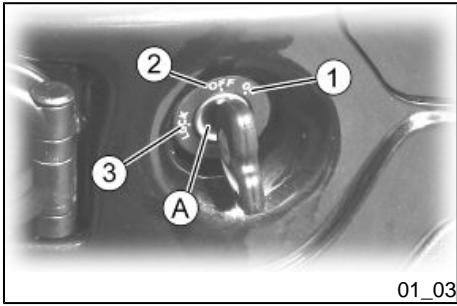

The water temperature warning light "G" and the injection warning light "N", to switch from "OFF" to "ON" position, light up for 3-4 seconds to indicate the correct operation of the failure indicator warning light.

Locking the steering wheel

Turn the handlebar to the left (as far as it will go), turn the key to «**LOCK**» and remove the key.

Releasing the steering wheel

Reinsert the key and turn it to «**OFF**».

Switchdirectionindicators (01_04)

Move the switch «C» to the left to indicate a left turn; Move the switch «C» to the right to indicate a right turn; Press the central part of the switch «C» to deactivate the turn indicators.

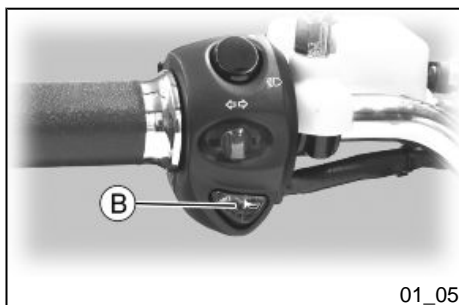
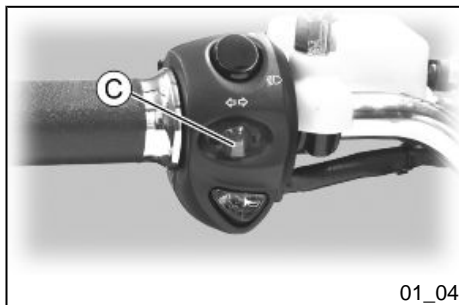

Hornbutton (01_05)

Push the button «B» to sound the horn.

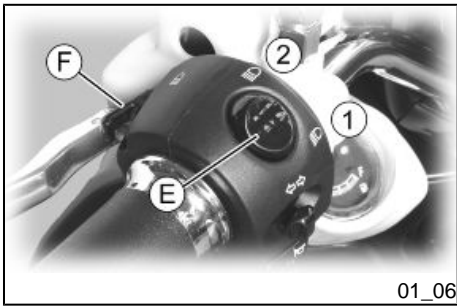

Lightswitch (01_06)

When the light switch «E» is set to «1», the low-beam light is on. When set to «2», the high-beam light is activated. Push the button «F» and the high-beam light is flashed.

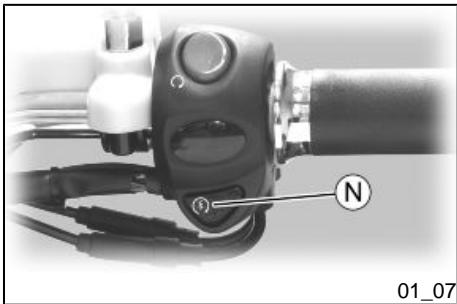

Start-upbutton (01_07)

To start the engine, pull either brake lever and press the button «N».

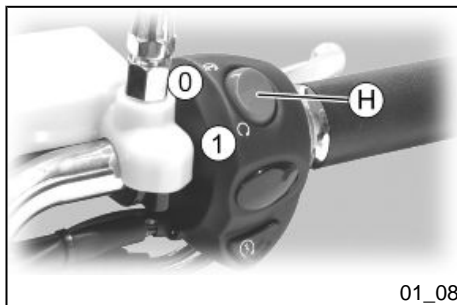

Enginestopbutton (01_08)

The engine can be started when the emergency cut-off switch «H» is set to «1» **RUN**; if the emergency cut-off switch «H» is set to «0» **OFF**, the engine cannot be started or it shuts off if already running.

The immobilizersystem

In order to enhance theft protection, the vehicle is equipped with a «**PIAGGIO IMMOBILIZER** » electronic engine locking device that is activated automatically when the ignition switch is removed. Upon start-up, the «**PIAGGIO IMMOBILIZER**» system checks the starter key, and only if this key is recognised will the Immobiliser system allow the vehicle to be started.

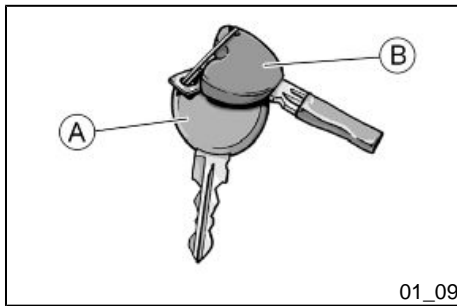

Keys (01_09, 01_10, 01_11)

Two types of keys are supplied together with the vehicle. The red handgrip key «**A**» is the «**MASTER**» key. Only a single copy of this key is supplied, which is necessary to program all your other keys and for your dealer to perform some maintenance operations. For this reason it is advised that it be used only in exceptional circumstances. The black key "**B**" (single copy supplied) is used for normal operations such as:

- engine start up
- glove-box opening

Together with the keys comes a CODE CARD which is imprinted with the mechanical code of the keys.

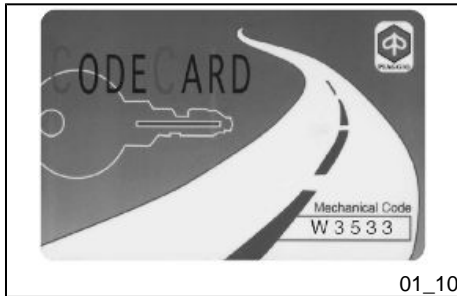

WARNING



LOSING THE RED KEY PREVENTS ANY REPAIRS OF THE 'PIAGGIO IMMOBILIZER' SYSTEM AND THE ENGINE CONTROL UNIT.

WARNING



KEEP THE 'CODE CARD' AND THE RED HANDGRIP KEY IN A SAFE PLACE (NOT ON YOUR VEHICLE).

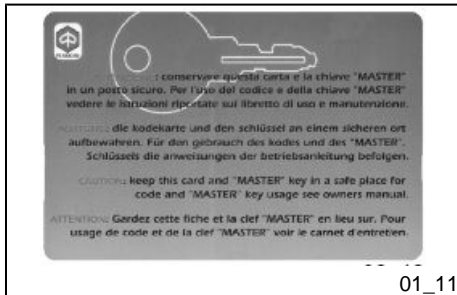

conservare questa carta e la chiave "MASTER" in un posto sicuro. Per l'uso del codice e della chiave "MASTER" vedere le istruzioni riportate sul libretto di uso e manutenzione.

Wichtig: die Karte und den Schlüssel an einem sicheren Ort aufbewahren. Für den Gebrauch des Codes und der "MASTER"-Schlüssel die Anweisungen der Betriebsanleitung befolgen.

CAUTION: keep this card and "MASTER" key in a safe place for code and "MASTER" key usage see owners manual.

ATTENTION: Gardez cette fiche et la clef "MASTER" en lieu sûr. Pour usage de code et de la clef "MASTER" voir le carnet d'entretien.

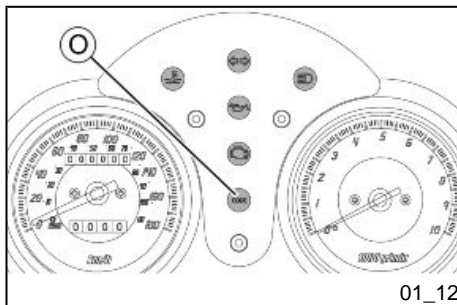

Immobilizer device enabled indicator led (01_12)

Activation of the «PIAGGIO IMMOBILIZER» system is signalled by a flashing «O» warning light.

In order to reduce battery discharge, the indicator LED turns off automatically after 48 hours of uninterrupted functioning.

Should the system fail, different LED flashing patterns will provide the **Authorised Service Centre** with information on the type of fault detected.

Operation

Every time the starter key is extracted from either the «OFF» or «LOCK» position, the protection system activates the engine lock. Turning the key to «ON», with the emergency cut-off switch set to «ON» and the side stand up, disables the engine lock provided that the safety system recognises the code transmitted by the key. If the code is not recognised, turn the key first to "OFF" and then to "ON"; if the lock cannot be disabled, try with the other key supplied (red-coloured). If the engine cannot be started, contact an **Authorised Service Centre**, which is provided with the electronic equipment required to detect and repair the system. The immobilizer is also activated when the emergency cut-off switch stops the engine or the side stand is lowered. This happens even if the starter key is in «ON». When additional keys are required, please note that data storage (up to 7 keys max.) must be done on all keys, both new and existing ones. Take the red-handgrip key and all the black keys supplied to an **Au-**

thorised Service Centre. The codes of keys not submitted for the new storage procedure are deleted from the memory. Any lost keys will therefore not be enabled to start the engine.

WARNING



EACH KEY HAS ITS OWN AND UNIQUE CODE, WHICH MUST BE STORED IN THE SYSTEM CONTROL UNIT MEMORY.

VIOLENT SHOCKS MAY AFFECT THE ELECTRONIC COMPONENTS OF THE KEY.

IF OWNERSHIP OF THE VEHICLE IS TRANSFERRED TO ANOTHER PERSON, THE KEY WITH THE RED GRIP (AS WELL AS THE OTHER KEYS) AND THE "CODE CARD" MUST BE ALSO TRANSFERRED TO THE NEW OWNER.

Programmingtheimmobilizersystem

The procedure for programming the «**PIAGGIO IMMOBILIZER**» system and/or for storing other key codes is described below.

The programming procedure should be carried out with the engine stop switch set to «**RUN**».

Procedurestart-redkey

Insert the red ignition key in the switch key (in "**OFF**" position) and turn it to "**ON**". After 1 - 3 seconds, turn the key to «**OFF** » again and pull it out.

Intermediate step-black key

After pulling out the red key, insert the black key within 10 seconds and promptly turn it to «**ON**». After 1-3 seconds, turn the key to «**OFF**» again and pull it out. In this way, a maximum of 7 black keys can be programmed by repeating the above procedure keeping the indicated times.

Final step-red key

After pulling out the last black key, insert the red key again and turn it to "**ON**" (this operation should be performed within 10 seconds of pulling out the previous key). Leave it in this position for 1 to 3 seconds and return it to «**OFF**».

Proper programming check

Insert the red key disabling the transponder (i.e., tilt the key cap by 90°) and turn the key to "**ON**". Perform the engine starter operation. Ensure that the engine does not start. Insert the black key and repeat the start-up operation. Check that engine starts.

WARNING

SHOULD THE ENGINE START WITH THE RED KEY (WITH TRANSPONDER OFF), OR IN THE EVENT OF WRONG OPERATION DURING PROGRAMMING, REPEAT THE PROCEDURE FROM THE BEGINNING.

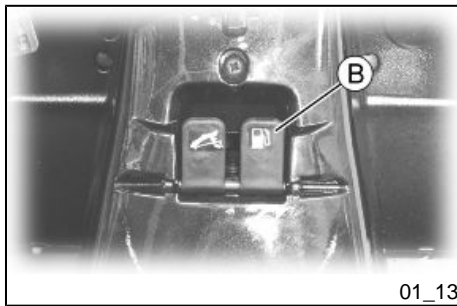

Accessing the fuel tank (01_13, 01_14)

Insert the key into the switch and press down until the glove box opens. In the event that the key switch is in «**LOCK**», turn the key to «**OFF**» or «**ON**» before pressing down. Press lever «**B**» and open the cover over the fuel tank cap «**C**».

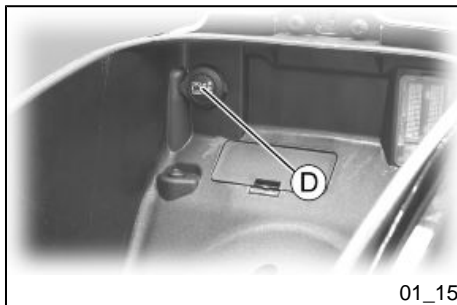
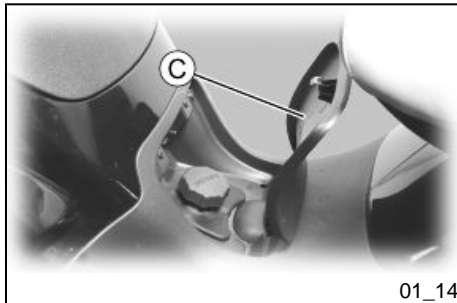

Power supply socket (01_15)

There is a plug socket «**D**» inside the helmet compartment.

The plug socket may be used for external consumers (mobile phone, inspection light, etc.).

CAUTION

PROLONGED USE OF THE PLUG SOCKET MAY RESULT IN PARTIAL DISCHARGE OF THE BATTERY

Electric characteristic**Plug socket**

12 V - 180 W MAX

The saddle (01_16, 01_17)

The saddle is supplied with a protection cover which may be used in case of rain. Lift the saddle and extract the cover from its housing. Fit it over the seat without pulling excessively to avoid tears and lower the seat again.

CAUTION

DON'T RIDE THE VEHICLE WITH THE PROTECTION COVER ON THE SADDLE .

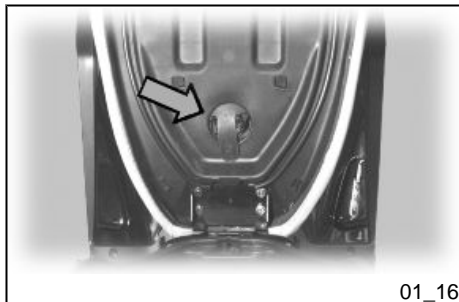

01_16

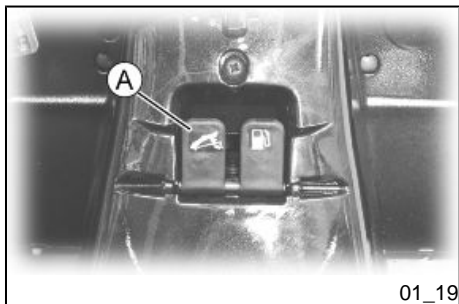
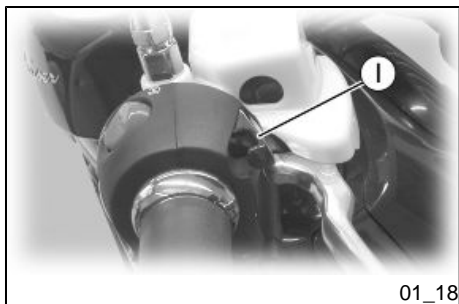

Openingthesaddle (01_19)

With the key set to «OFF» or «ON», or with engine on, the saddle can be opened by means of an electrical device by pressing button «1». If the electric opening does not work, use the emergency lever "A". When the key is set to «LOCK» the saddle cannot be opened.

Identification (01_20, 01_21)

Identification registration numbers are made up of a prefix and a number, stamped on the chassis and on the engine. These numbers must always be quoted when ordering spare parts. We recommend checking that the chassis registration number stamped on the vehicle corresponds with that on the vehicle documentation.

CAUTION



PLEASE REMIND THAT ALTERING IDENTIFICATION REGISTRATION NUMBERS CAN LEAD TO SERIOUS PENAL SANCTIONS (IMPOUNDING OF THE VEHICLE, ETC.).

Chassis number

To read the chassis number, remove the lid «A» in the helmet compartment.

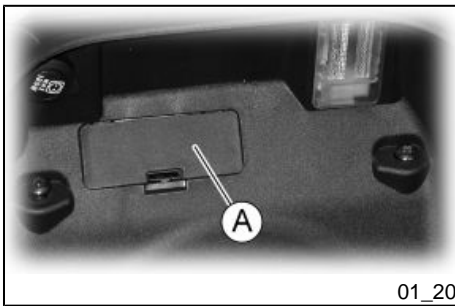

Engine number

The engine number «**B**» is stamped near the rear left shock absorber lower support.

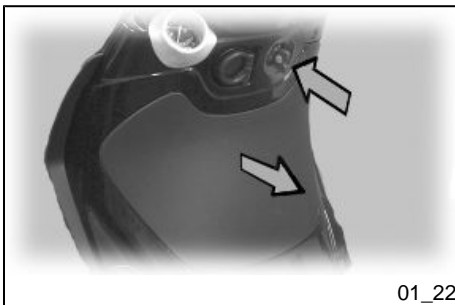
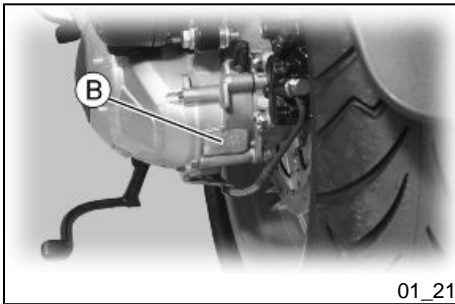

Rear top box opening (01_22)

Insert the key into the switch and press down until the glove compartment opens. In the event that the switch is in «**LOCK**», turn the key to «**OFF**» or «**ON**» before pressing it.

Bagclip (01_23)

To use the retractable bag hook «**B**» mounted on the leg shield back plate, pull it slightly towards the back of the vehicle.

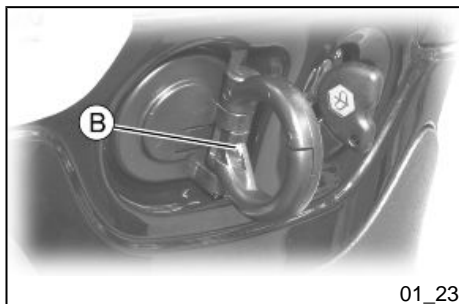

BEVERLY Cruiser 250ie



PIAGGIO®



Chap. 02
Use

Checks

Before using the vehicle, check:

1. That there is enough fuel in the fuel tank.
2. Front and rear brake fluid level
3. That tyres are properly inflated.
4. The correct functioning of the tail lights, the headlight, and the turn indicators.
5. The correct functioning of front and rear brakes.
6. The oil level in the gearcase.
7. Engine oil level.
8. The coolant level

Refuelling (02_01)

Reach the fuel tank and unscrew the cap «A».

Use premium unleaded petrol, with minimum octane rating of 95.

A specific gauge on the instrument panel indicates the fuel level.

WARNING



SWITCH OFF THE ENGINE BEFORE REFUELLING WITH PETROL.

PETROL IS HIGHLY INFLAMMABLE.

DO NOT SMOKE AND KEEP NAKED FLAMES AT A DISTANCE: FIRE HAZARD.

DO NOT INHALE FUEL FUMES.

DO NOT ALLOW PETROL TO COME INTO CONTACT WITH HOT ENGINE OR ANY PLASTIC PARTS.

CAUTION



PETROL DAMAGES THE PLASTIC PARTS OF THE BODYWORK.

CAUTION



DO NOT USE THE VEHICLE TO THE COMPLETE EXHAUSTION OF THE FUEL; SHOULD THIS OCCUR, DO NOT ATTEMPT TO START THE ENGINE. TURN THE IGNITION SWITCH TO «OFF» AND TOP-UP THE TANK AS SOON AS POSSIBLE. FAILURE TO FOLLOW THESE GUIDELINES COULD DAMAGE THE FUEL PUMP AND/OR THE CATALYTIC CONVERTER.

Characteristic

Fuel tank (reserve)

~ 10 l (2 l)

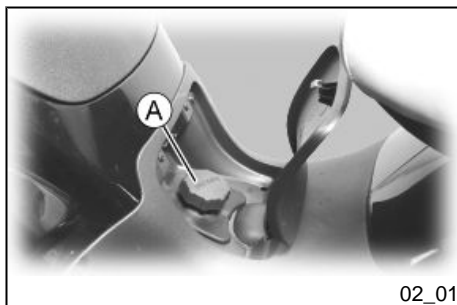

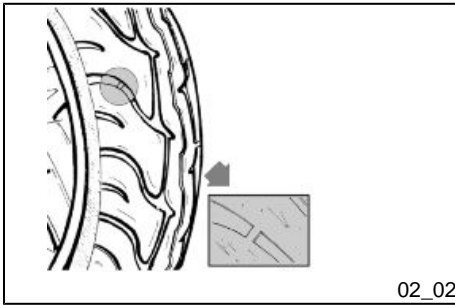

Tyrepressure (02_02)

Check tyre pressure and wear periodically as indicated in the scheduled maintenance table.

The tyres are equipped with wear indicators, according to which the tyres should be changed before these indicators come to the surface of the tread.

Also check that the tyres do not show signs of splitting at the side or irregular tread wear; if this occurs, go to an authorised workshop or at least to a workshop equipped to perform the replacement.

CAUTION



TYRE PRESSURE SHOULD BE CHECKED WHEN TYRES ARE COLD. INCORRECT TYRE PRESSURE CAUSES ABNORMAL TYRE WEAR AND MAKES RIDING DANGEROUS.

TYRES MUST BE REPLACED WHEN THE TREAD REACHES THE WEAR LIMITS SET FORTH BY LAW.

Characteristic

Front tyre pressure (with passenger)

2 bar (-)

Rear tyre pressure (with passenger)

2.5 bar (-)

Shockabsorbersadjustment (02_03, 02_04)

The preloading of the springs can be adjusted to 4 positions acting on the ring nut located in the lower part of the shock absorbers with the specific spanner supplied.

Position 1: minimum preload: rider only

Position 2 medium preloading: rider only

Position 3 medium preloading: rider and passenger

Position 4: maximum preloading: rider, passenger, and luggage.

In order to carry out this operation you will need to use the specific spanner in the kit. Spring preloading increases by turning the ring nut towards «**A**», but decreases if the ring nut is turned towards «**B**».

CAUTION



RIDING THE VEHICLE WITH THE SPRING PRELOADING NOT CORRECTLY SET FOR THE RIDER AND POSSIBLE PASSENGER, COULD REDUCE THE COMFORT OF THE RIDE AND THE PRECISION OF THE STEERING.

WARNING



WE RECOMMEND WEARING GLOVES WHILE CARRYING OUT THIS OPERATION IN ORDER TO AVOID INJURIES.



02_03

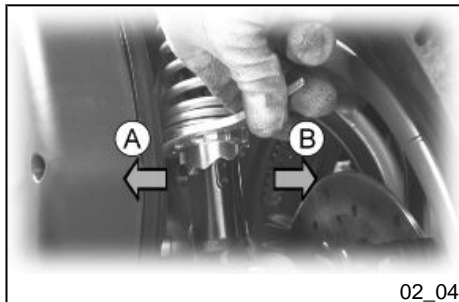

02_04

WARNING

IT IS ABSOLUTELY FORBIDDEN TO ADJUST THE PRELOAD DIFFERENTLY ON THE TWO SHOCK ABSORBERS

Running in**WARNING**

DURING THE FIRST 1000 KM DO NOT RIDE THE VEHICLE OVER 80% OF ITS MAXIMUM SPEED. AVOID TWISTING THE THROTTLE GRIP FULLY OR KEEPING A CONSTANT SPEED ALONG LONG SECTIONS OF ROAD. AFTER THE FIRST 1000 KM, GRADUALLY INCREASE SPEED UNTIL REACHING THE MAXIMUM PERFORMANCE.

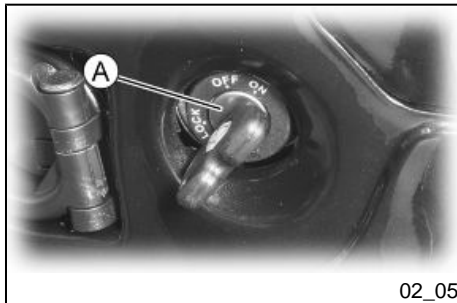

02_05

Starting up the engine (02_05, 02_06, 02_07)

The vehicle is equipped with an ignition prevention system controlled by the side stand.

The engine cannot be started if the side stand is lowered.

If the engine is on, it will turn itself off if the side stand is lowered.

To start the engine it is necessary, before pressing the starter button, to pull and keep pulled the front or rear brake lever, which activates the appropriate switch allowing start-up.

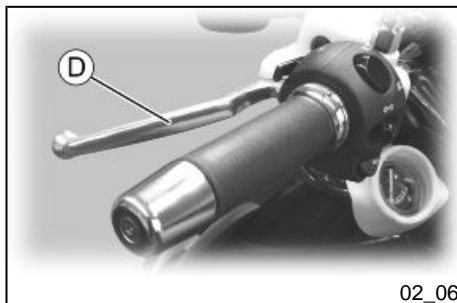

02_06

1. Rest the vehicle on its centre stand, ensuring the rear wheel is not touching the ground.
2. Keep the hand grip accelerator at the minimum.
3. Insert the key into the ignition switch «A» and turn it to «ON».
4. Make sure that the emergency stop switch «H» is set to «RUN» and the side stand is up and not engaged.
5. Pull either the front, «L», or rear, «D», break lever and then press the starter button «N».

WARNING



THE AUTOMATIC TRANSMISSION MAKES THE REAR WHEEL TURN EVEN WHEN THE THROTTLE IS SLIGHTLY TWISTED. RELEASE THE BRAKE CAREFULLY AFTER STARTING, AND THEN ACCELERATE GRADUALLY.

CAUTION



DO NOT START-UP THE ENGINE IN CLOSED AREAS BECAUSE EXHAUST GASES ARE TOXIC.

Precautions

CAUTION



NEVER STRESS THE ENGINE AT LOW TEMPERATURES IN ORDER TO AVOID POSSIBLE DAMAGE. BE CAREFUL NEVER TO EXCEED THE MAXIMUM SPEED WHILE RUNNING DOWNHILL, IN ORDER TO AVOID DAMAGING THE ENGINE.

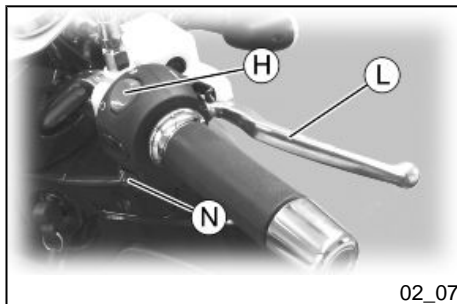

02_07

IN ANY CASE, IN ORDER TO PRESERVE THE ENGINE FROM PROLONGED OVERREVVING, THE REVOLUTION LIMITER WILL BE ACTIVATED IF THE ENGINE SPEED EXCEEDS THE ESTABLISHED THRESHOLD.

WARNING



AFTER A LONG DISTANCE COVERED AT THE MAXIMUM SPEED, DO NOT STOP THE ENGINE IMMEDIATELY, BUT LET IT RUN AT IDLE FOR A FEW SECONDS.

Difficultstartup

In the rare case of engine flooding, to facilitate start-up, it is possible to try to put the vehicle into action with the gas hand grip partially or completely open. It is however necessary, once the engine is started, to take your vehicle to an **Authorised Service Centre** to determine the cause of this problem and to re-establish the vehicle proper functioning.

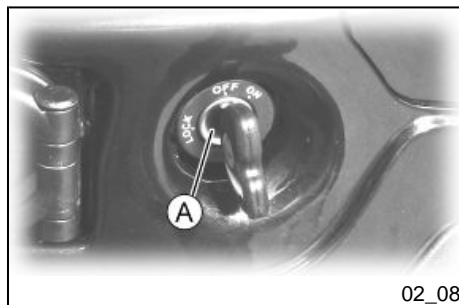

Stoppingtheengine (02_08)

Fully untwist the throttle grip, then rotate the key in the switch «A » to «KEY OFF» (extractable key).

CAUTION



DUE TO THE HIGH TEMPERATURES THE CATALYTIC CONVERTER CAN REACH, ALWAYS TAKE CARE, WHEN PARKING THE VEHICLE, THAT THE EXHAUST DOES NOT COME INTO CONTACT WITH FLAMMABLE MATERIALS, TO AVOID SERIOUS BURNS.

CAUTION

DO NOT SHUT OFF THE ENGINE WHILE THE VEHICLE IS MOVING. UNBURNED FUEL COULD ENTER THE CATALYTIC CONVERTER AND BURN, CAUSING THE CONVERTER TO OVERHEAT AND POSSIBLY DESTROYING IT.

WARNING

TO START AFTER A LONG STATIONARY PERIOD, OR IN SEVERE WEATHER CONDITIONS, FULLY TWIST THE THROTTLE 2÷3 TIMES BEFORE PRESSING THE STARTER BUTTON.

Stand (02_09)**Centre stand**

Push with your foot on the centre stand's fork "F" while lifting the vehicle backward, holding onto the handlebar.

Side stand

Push with your foot on the stand's prong «L» until it releases into position, while lowering the vehicle onto the stand.

WARNING

THE SIDE STAND CAUSES THE ENGINE TO TURN ITSELF OFF WHENEVER IT IS LOWERED.

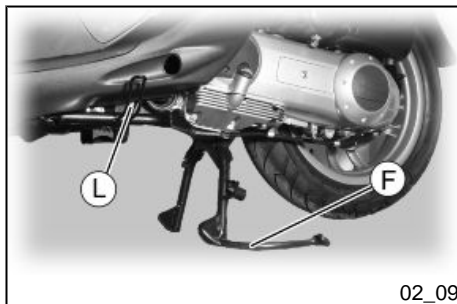

02_09

WARNING

TAMPERING MAY CAUSE SERIOUS ENGINE MALFUNCTION.

CAUTION

DUE TO THE HIGH TEMPERATURES THE CATALYTIC CONVERTER CAN REACH, ALWAYS TAKE CARE, WHEN PARKING THE VEHICLE, THAT THE EXHAUST DOES NOT COME INTO CONTACT WITH FLAMMABLE MATERIALS, TO AVOID SERIOUS BURNS.

CAUTION

DO NOT SHUT OFF THE ENGINE WHILE THE VEHICLE IS MOVING. UNBURNED FUEL COULD ENTER THE CATALYTIC CONVERTER AND BURN, CAUSING THE CONVERTER TO OVERHEAT AND POSSIBLY DESTROYING IT.

Automatictransmission

To ensure simple, pleasurable riding, the vehicle is equipped with automatic transmission with regulator and centrifugal clutch. The system is designed to provide the best performance (acceleration and consumption) while driving on both flat roads and uphill.

If you have to stop up a hill (traffic lights, traffic jam, etc.) **use only the brake to keep the vehicle still, leaving the engine running at idle speed. Using the engine to keep the vehicle still can cause the clutch to overheat, due to the friction of the clutch mechanism itself against the capstan.**

It is therefore recommended to avoid conditions of prolonged clutch slippage (other than those previously indicated) like driving uphill fully laden on steep slopes or starting off with driver and passenger at slopes greater than 25%.

Take the following precautions if the clutch overheats:

1. Do not continue riding in such conditions.
2. Let the clutch cool down with the engine at idle speed for a few minutes.

Safedriving

Some simple tips are provided below that will enable you to use your vehicle on a daily basis, confidently and safely. Your skill and your mechanical knowledge are the basis of safe riding. We recommend trying out the vehicle in traffic-free zones in order to acquire a good knowledge of the vehicle it self.

1. Before riding off, remember to put on the helmet and fasten it correctly.
2. Reduce speed on rough roads and ride with care.
3. After riding on a long stretch of wet road without using the brakes, braking can be poor at the beginning. In these conditions, it is a good idea to apply the brakes from time to time.
4. Do not brake hard on wet, unsurfaced or slippery roads.
5. Avoid riding off by mounting the scooter when it is resting on its support. In any case, in order to avoid abrupt departures, the rear wheel should not be turning when it comes into contact with the ground.
6. If the vehicle is used on roads covered with sand, mud, snow mixed with salt, etc., clean the brake disc frequently with a mild detergent in order to prevent abrasive particles from building up inside the holes, which can result in early brake pad wear.

CAUTION

ALWAYS RIDE WITHIN YOUR LIMITS RIDING UNDER THE INFLUENCE OF ALCOHOL OR OTHER DRUGS AND CERTAIN MEDICINES IS EXTREMELY DANGEROUS.

CAUTION

ANY ELABORATION THAT MODIFIES THE VEHICLE'S PERFORMANCES, SUCH AS TAMPERING WITH ORIGINAL STRUCTURAL PARTS IS STRICTLY FORBIDDEN BY LAW, AND RENDERS THE VEHICLE NO LONGER CONFORMING TO THE APPROVED TYPE AND DANGEROUS FOR RIDING.

CAUTION

DO NOT ADJUST THE MIRRORS WHILE RIDING. THIS COULD CAUSE YOU TO LOOSE CONTROL OF THE VEHICLE.

WARNING

IN ORDER TO PREVENT ANY ACCIDENTS RIDE VERY CAREFULLY AFTER ADDING ACCESSORIES AND WHILE CARRYING LUGGAGE. THE ADDITION OF ACCESSORIES AND LUGGAGE CAN REDUCE YOUR SCOOTER STABILITY AND PERFORMANCE, AS WELL AS THE LEVEL OF SAFETY DURING USE. NEVER DRIVE THE SCOOTER EQUIPPED WITH ACCESSORIES AT A SPEED HIGHER THAN 100 km/h (see section "SPARE PARTS AND ACCESSORIES")

BEVERLY Cruiser 250ie



PIAGGIO®



**Chap. 03
Maintenance**

Engineoillevel

In 4T engines, the engine oil is used to lubricate the distribution elements, the bench bearings and the thermal group. **An insufficient quantity of oil can cause serious damage to the engine.** In all four-stroke engines, a loss of efficiency in oil performance and consumption should be considered normal. Consumption can particularly reflect the conditions of use (i.e. when driving at "full acceleration" all the time, oil consumption increases). **In order to prevent any problems, we recommend checking the oil level any time you use the vehicle. The vehicle is, however, equipped with an oil pressure warning light on the instrument panel.**



Engineoillevelcheck (03_01, 03_02)

Every time the vehicle is used, visually inspect the level of the engine oil when the engine is cold (after **completely unscrewing** the oil cap/dipstick). The oil level should be somewhere between the MAX and MIN index marks on the level rod; «A»; while the oil is being checked, the vehicle must be resting on its centre stand on an even, horizontal surface.

If the check is carried out after the vehicle has been used, and therefore with a hot engine, the level will be lower; in order to carry out a correct check, wait at least 10 minutes after the engine has been stopped so as to get the correct level.

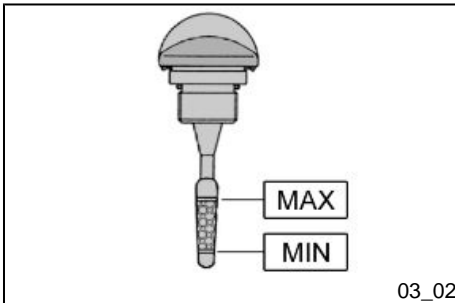

Engineoiltop-up

Always check the oil level before topping up, and add oil **without exceeding the MAX** level. Getting an oil level between the **MIN** and **MAX** levels requires ~ 200 cm³ of oil. Take your vehicle to an **Authorised Service Centre** to have the oil checked and if necessary, topped-up as indicated in the scheduled maintenance table.

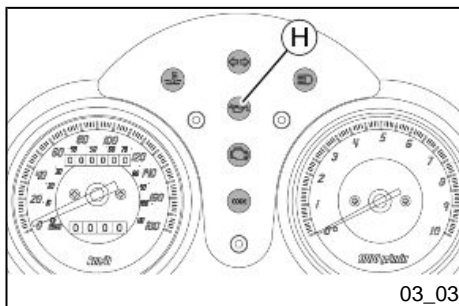

03_03

Warninglight(insufficientoilpressure) (03_03)

The scooter is equipped with a warning light «H» that lights up when the key is turned to «ON».

However, this light should come off once the engine has been started.

If the light comes on while braking, at idle speed or while turning a corner, it is necessary to check the oil level and top it up if required. If after having topped-up the oil, the warning light still comes on while braking, at idle speed or while turning a corner, it will be necessary to take your vehicle to an Authorised Service Centre.

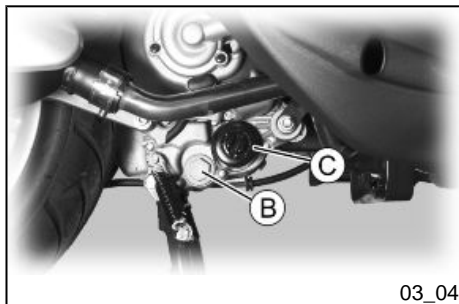

03_04

Engineoilchange (03_04)

The oil and the cartridge filter «C» must be changed as indicated in the scheduled maintenance table at an **Authorised Service Centre**. The engine should be emptied by draining the oil from the drainage plug «B» of the gauze filter on the flywheel side. In order to facilitate the oil drainage, loosen the cap/dipstick. Since a certain quantity of oil still remains in the circuit, filling must be done with approx. 600 ÷ 650 cm³ of oil through the cap «A». Then start up the scooter, leave it running for a few minutes and switch it off: after five minutes, check the level and if necessary top-up **without exceeding the MAX. level**. The cartridge filter must be replaced at every oil change. For top-ups and changes, use new oil of the recommended type.

WARNING

RUNNING THE ENGINE WITH INSUFFICIENT LUBRICATION OR WITH INADEQUATE LUBRICANTS ACCELERATES THE WEAR AND TEAR OF THE MOVING PARTS AND CAN CAUSE IRRETRIEVABLE DAMAGE.

WARNING

EXCESSIVE OIL LEVEL AT TOP-UPS CAN LEAD TO SCALE FORMATION AND VEHICLE MALFUNCTION.

CAUTION

USED OILS CONTAIN SUBSTANCES HARMFUL TO THE ENVIRONMENT. FOR OIL CHANGE, CONTACT AN AUTHORISED SERVICE CENTRE WHICH IS EQUIPPED TO DISPOSE OF USED OILS IN AN ENVIRONMENTALLY FRIENDLY AND LEGAL WAY.

CAUTION

USING OILS OTHER THAN THOSE RECOMMENDED CAN SHORTEN THE LIFE OF THE ENGINE.

Recommended products

eni i-Ride PG 5W-40

*Synthetic based lubricant for high-performance four-stroke engines.
JASO MA, MA2 - API SL - ACEA A3*

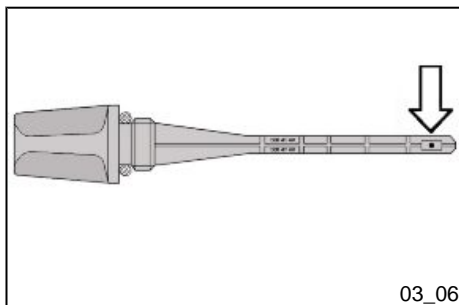
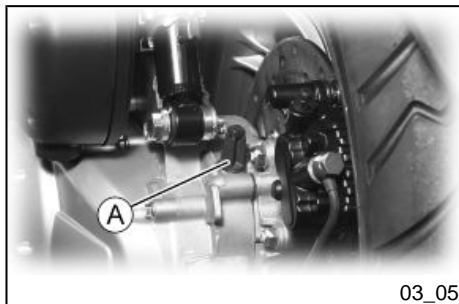

Huboillevel (03_06)

Check the oil in the rear hub.

To check the rear hub oil level, proceed as follows:

- 1) Park the scooter on level ground and place it on the centre stand.
- 2) Unscrew the dipstick "A", dry it with a clean rag and then reinsert it, **screwing it tightly into place**;

- 3) Remove the dipstick and check that the oil level is above the first notch from the bottom.
- 4) Screw the dipstick back in, checking that it is locked in place.

N.B.

THE REFERENCE MARKS ON THE HUB OIL LEVEL DIPSTICK, EXCEPT FOR THE ONE INDICATING THE "MAX" LEVEL, REFER TO OTHER MODELS BY THE MANUFACTURER AND HAVE NO SPECIFIC FUNCTION FOR THIS MODEL.

CAUTION

RIDING THE VEHICLE WITH INSUFFICIENT HUB LUBRICATION OR WITH CONTAMINATED OR IMPROPER LUBRICANTS ACCELERATES THE WEAR AND TEAR OF THE MOVING PARTS AND CAN CAUSE SERIOUS DAMAGE.

CAUTION

USED OILS CONTAIN SUBSTANCES HARMFUL TO THE ENVIRONMENT. FOR OIL REPLACEMENT, CONTACT AN AUTHORISED SERVICE CENTRE WHICH IS EQUIPPED TO DISPOSE OF USED OILS IN AN ENVIRONMENTALLY FRIENDLY AND LEGAL WAY.

CAUTION

UPON REPLACING HUB OIL, AVOID THE OIL COMING INTO CONTACT WITH THE REAR BRAKE DISC.

Recommended products

AGIP GEAR SAE 80W-90

Lubricant for gearboxes and transmissions.

API GL-4

Characteristic

Transmission oil

250 cm³

Tyres (03_07)

Check tyre pressure frequently. Tyres feature wear indicators; replace tyres as soon as these indicators become visible on the tyre tread. Also check that the tyres do not show signs of splitting at the side or irregular tread wear; if this occurs, go to an authorised workshop or at least to a workshop equipped to perform the replacement.

CAUTION



TYRE PRESSURE SHOULD BE CHECKED WHEN TYRES ARE COLD. INCORRECT TYRE PRESSURE CAUSES ABNORMAL TYRE WEAR AND MAKES RIDING DANGEROUS.

TYRES MUST BE REPLACED WHEN THE TREAD REACHES THE WEAR LIMITS SET FORTH BY LAW.

Characteristic

Front tyre pressure (with passenger)

2 bar (-)

Rear tyre pressure (with passenger)

2.5 bar (-)

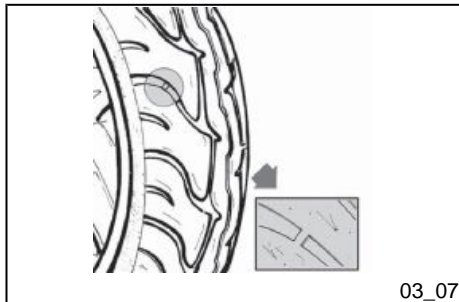

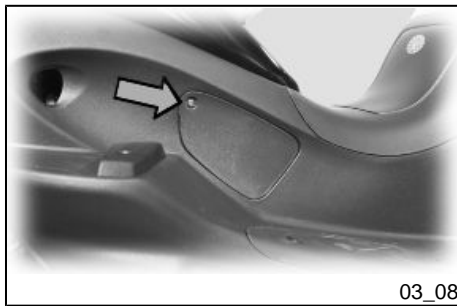

03_08

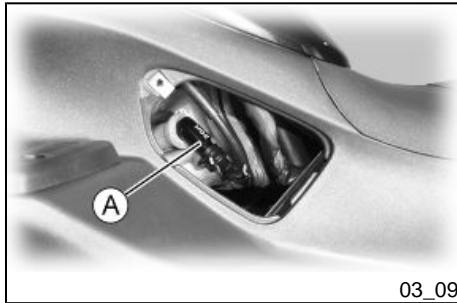

03_09

Sparkplugdismantlement (03_08, 03_09)

Proceed as follows:

- 1.Remove the access cover over the spark plug on the right-hand side of the scooter, reach the spark plug and slide it off with your hand;
- 2.Disconnect spark plug HV wire cap «A»;
3. Unscrew the spark plug using the wrench supplied;
- 4.Upon refitting, place the spark plug into the hole at the required angle and tighten it by hand.
- 5.Use the wrench only to tighten it;
- 6.Push cap «A » fully over the spark plug.

N.B.

USE OF SPARK PLUGS OTHER THAN THE INDICATED TYPE OR UNSHIELDED SPARK PLUG CAPS CAN LEAD TO FAULTS IN THE VEHICLE 'S ELECTRICAL SYSTEM.

WARNING



THE SPARK PLUG MUST BE REMOVED WHEN THE ENGINE IS COLD. CHECK THE SPARK PLUG AS INDICATED IN THE SCHEDULED MAINTENANCE TABLE. USING NON-COMPLYING ELECTRONIC CENTRAL UNITS AND ELECTRONIC IGNITIONS OR SPARK PLUGS OTHER THAN THOSE PRESCRIBED MAY SERIOUSLY DAMAGE THE ENGINE. IF THE SPARK PLUG IS REMOVED AFTER A FLOODED ENGINE (EXCESSIVE FUEL EXPULSION IN THE «SAFE RIDING» SECTION), KEEP THE TUBE CONNECTED TO THE SPARK PLUG AND THE LATTER IN CONTACT WITH A GROUND POINT FAR FROM THE SPARK PLUG HOLE ITSELF IN ORDER TO AVOID THE EXPELLED FUEL FROM CATCHING FIRE.

Characteristic

Spark plug

CHAMPION RG 4 PHP

Electrode gap

0.7 to 0.8 mm

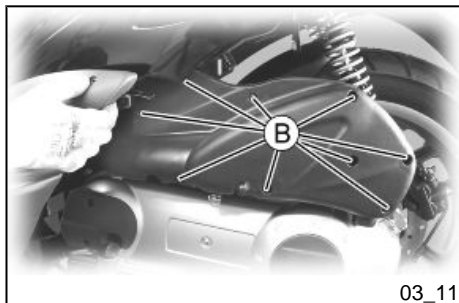
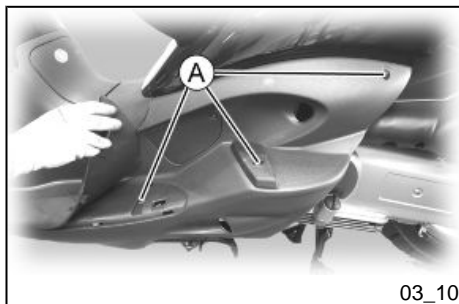

Removing the air filter (03_11)

To access the air filter:

1. Lift the footrest mat and undo the three screws «A».

2. Remove the right footrest to have access to the nine screws «B» and unscrew them.
3. Remove the air filter cover «C».

Airfiltercleaning

1. Wash the sponge with water and mild soap.
2. Dry it with a clean cloth and short blasts of compressed air.
3. Impregnate the sponge with a mixture of 50% petrol and 50% specified oil.
4. Gently squeeze the filtering element, let it drip dry and then refit it.

CAUTION



IF THE VEHICLE IS USED ON DUSTY ROADS IT IS NECESSARY TO CARRY OUT MAINTENANCE CHECKS OF THE AIR FILTER MORE OFTEN TO AVOID DAMAGING THE ENGINE.

Recommended products

AGIP FILTER OIL

Special product for the treatment of foam filters.

-

Coolingfluidlevel (03_12, 03_13, 03_14)

Engine cooling is carried out by a forced-circulation coolant system. The cooling circuit holds approx. 1.7 litres of coolant consisting of a mixture of 50% de-ionised water and 50% glycol ethylene-based antifreeze solution with corrosion inhibitors.

The coolant supplied with the scooter is already mixed and ready for use.

For proper functioning of the engine, ensure that the temperature of the coolant is not too high. If the warning light «G» placed in the instrument panel lights up, stop the engine, cool it down and check the coolant level; if the level is OK, contact an **Authorised Service Centre**.

Check coolant when the engine is cold as indicated in the scheduled maintenance table, following the steps below.

- Place the scooter in a vertical position on the stand.
- Unscrew the fixing screw «A» and remove the cover.
- Remove the expansion tank cover "B", turning in anticlockwise direction.
- Look inside the expansion tank; a scale in the plastic indicates the maximum and minimum level of the coolant.
- Top up the cooling fluid if the fluid level is below the minimum level margin inside the expansion tank.

The fluid level must always be between MIN and MAX level

If the fluid is near the minimum level, proceed with the top-up operation to be carried out when the engine is cold. If it is necessary to top up the coolant frequently, or if the expansion tank is completely dry, you should look for the cause in the cooling system.

It is therefore essential to have the cooling system checked at an **Authorised Service Centre**.

Replace coolant as indicated in the scheduled maintenance table.

Take your vehicle to an **Authorised Service Centre** for this operation.

N.B.

IF DURING A NON-DEMANDING RIDE THE COOLANT WARNING LIGHT COMES ON, SHUT OFF THE ENGINE AND ALLOW IT TO COOL DOWN. THEN CHECK

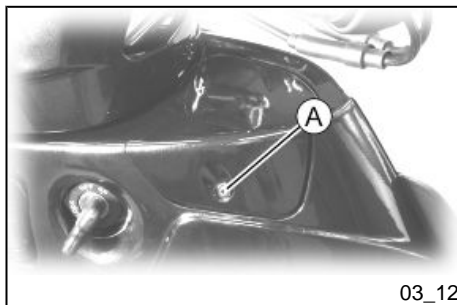

03_12

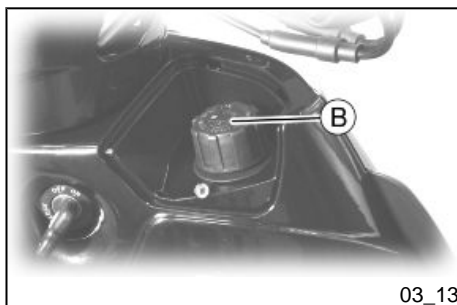

03_13

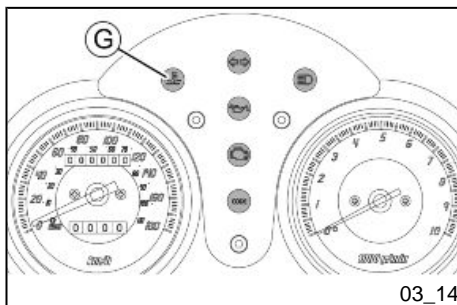

03_14

THE COOLANT LEVEL; IF THE LEVEL IS NOT CORRECT, CONTACT AN AUTHORISED SERVICE CENTRE.

WARNING



TO AVOID THE RISK OF SCALDING, DO NOT UNSCREW THE EXPANSION TANK COVER WHILE THE ENGINE IS STILL HOT.

WARNING



TO PREVENT AVOID HARMFUL FLUID LEAKAGE WHILE RIDING, ENSURE THAT THE LEVEL NEVER EXCEEDS THE MAXIMUM VALUE.

TO ENSURE CORRECT ENGINE OPERATION, KEEP THE RADIATOR GRILLE CLEAN.

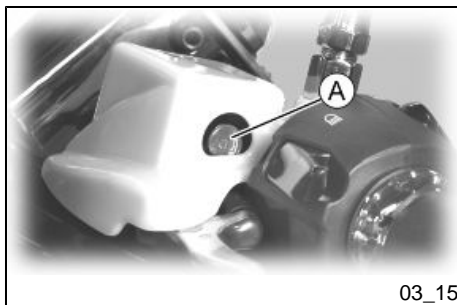

Checking the brake oil level (03_15)

The front and rear brake fluid reservoirs are both positioned on the handlebar. Proceed as follows:

1. Rest the scooter on its centre stand with the handlebars perfectly horizontal;
2. Check fluid level through the related warning light «A».

A certain lowering of the level is caused by wear on the brake pads. Should the level appear to be below the minimum mark, please contact an **Authorised Service Centre or Dealer** in order to have a thorough inspection of the braking system carried out.

Brakingsystemfluidtopup (03_16, 03_17)

Instructions refer to one braking system only, but they are valid for both.

Remove the rear-view mirror undoing the nut «**A**» and remove the plastic cover «**B**». Unscrew the two screws «**C**», remove the fuel tank cap and the intermediate rubber membrane, and top-up the brake fluid level only with the recommend brake fluid type and without exceeding the maximum level.

Under standard climatic conditions, replace fluid as indicated in the scheduled maintenance table. This operation must be carried out by trained personnel; take your vehicle to an **authorised Service centre or Dealer**.

WARNING



ONLY USE DOT 4-CLASSIFIED BRAKE FLUID. BRAKE CIRCUIT FLUID IS VERY CORROSIVE; MAKE SURE THAT IT DOES NOT COME INTO CONTACT WITH THE PAINTWORK.

CAUTION



AVOID CONTACT OF BRAKE FLUID WITH EYES, SKIN, AND CLOTHING. IN CASE OF CONTACT, RINSE WITH WATER. THE BRAKING CIRCUIT FLUID IS HYGROSCOPIC, THAT IS, IT ABSORBS HUMIDITY FROM THE SURROUNDING AIR. IF THE HUMIDITY IN THE BRAKING FLUID EXCEEDS A CERTAIN VALUE, IT WILL LEAD TO INEFFICIENT BRAKING. NEVER USE BRAKING FLUID KEPT IN CONTAINERS THAT HAVE ALREADY BEEN OPENED, OR PARTIALLY USED.

Recommended products

AGIP BRAKE 4

Brake fluid.

Synthetic fluid SAE J 1703 -FMVSS 116 - DOT 3/4 - ISO 4925 - CUNA NC 956 DOT 4

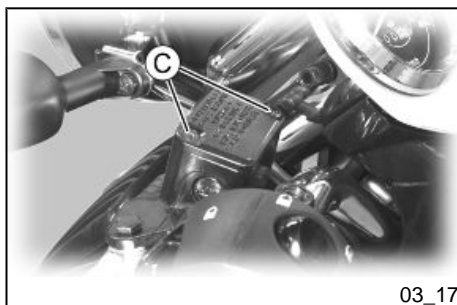
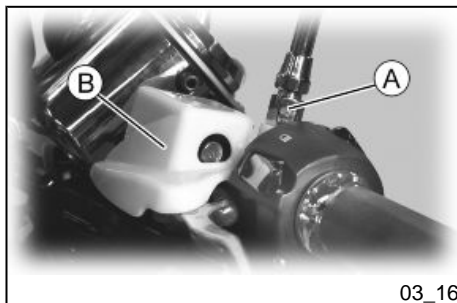

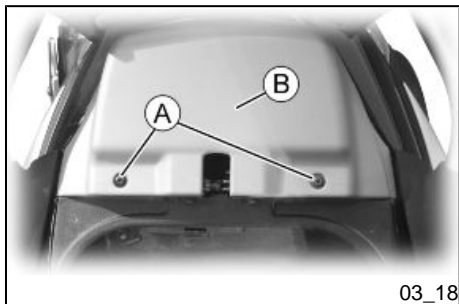

Battery (03_18)

To access the battery, proceed as follows:

1. rest the scooter on its centre stand.
2. open the saddle
3. remove the retainer «A» and the cover «B».
4. release the battery retaining ring.

The battery is the electrical device that requires the most frequent attention and the most thorough maintenance.

The main points of maintenance to be observed are as follows:

WARNING



DO NOT DISCONNECT THE BATTERY CABLES WITH THE ENGINE RUNNING, THIS CAN CAUSE IRREPARABLE DAMAGE TO THE VEHICLE'S ELECTRONIC CONTROL UNIT.

WARNING

THE ELECTROLYTE CONTAINS SULPHURIC ACID: AVOID CONTACT WITH EYES, SKIN AND CLOTHES. IN CASE OF ACCIDENTAL CONTACT, RINSE WITH ABUNDANT WATER AND CONSULT A DOCTOR.

WARNING

USED BATTERIES ARE HARMFUL FOR THE ENVIRONMENT. COLLECTION AND DISPOSAL SHOULD BE CARRIED OUT IN COMPLIANCE WITH REGULATIONS IN FORCE.

Characteristic**Battery**

SEALED 12V / 12Ah BATTERY

Use of a new battery

Position the battery in its housing and connect the positive lead «+» first and then the negative one «-». Check the voltage

CAUTION

DO NOT REVERSE THE POLARITY: RISK OF SHORT CIRCUIT AND DAMAGE TO THE ELECTRICAL SYSTEM.



Long periods of inactivity (03_19)

Battery performance will decrease if the vehicle is not used for a long time. This is the result of the natural phenomenon of battery discharging, and may be due to residual absorption by vehicle components with constant power consumption. Poor battery performance may also be due to environmental conditions and the cleanness of the poles. In order to avoid difficult starts and/or irreversible damage to the battery, follow any of these steps:

- **At least once a month** start the engine and run it slightly above idle speed for 10-15 minutes. This keeps all the engine components, as well as the battery, in good working order.

- Take your vehicle to a garage (as indicated in the «Vehicle not used for extended periods» section) to have the battery removed. Have the battery cleaned, charged fully and stored in a dry, ventilated place. Recharge **at least once every two months**.

CAUTION

THE BATTERY MUST BE CHARGED WITH A CURRENT EQUAL TO 1/10 OF THE RATED CAPACITY OF THE BATTERY AND FOR NOT LONGER THAN 10 HOURS. CONTACT AN AUTHORISED SERVICE CENTRE TO CARRY OUT THIS OPERATION SAFELY. WHEN REFITTING THE BATTERY MAKE SURE THE LEADS ARE CORRECTLY CONNECTED TO THE TERMINALS.

Fuses (03_20, 03_21, 03_22)

The electrical system is equipped with:

1. Six protective fuses «**A**» located inside the side panel on the right-hand side;
2. Four protective fuses «**B**» located inside the compartment on the upper left-hand side.

The chart shows the position and specifications of the fuses in the vehicle.

CAUTION

BEFORE REPLACING A BLOWN FUSE, FIND AND SOLVE THE FAILURE THAT CAUSED IT TO BLOW. NEVER TRY TO REPLACE THE FUSE WITH ANY OTHER MATERIAL (E.G., A PIECE OF ELECTRIC WIRE).

CAUTION

MODIFICATIONS OR REPAIRS TO THE ELECTRICAL SYSTEM, PERFORMED INCORRECTLY OR WITHOUT STRICT ATTENTION TO THE TECHNICAL SPECIFICATIONS OF THE SYSTEM CAN CAUSE MALFUNCTIONING AND RISK OF FIRE.

FUSES

Fuse No. 1

Capacity:7.5 A**Protected circuits:**Power supply from battery for injection electronic control unit.

Fuse No. 2

Capacity:7.5 A**Protected circuits:**Power supply from battery for immobilizer and arrows.

Fuse No. 3

Capacity:10 A

	Protected circuits: Power supply from battery for injection loads.
Fuse No. 4	Capacity: 15A Protected circuits: Power supply from battery for saddle opening, 12V-180W socket, electric fan, antitheft device, helmet compartment lightning.
Fuse No. 5	Capacity: 15A Protected circuits: Power supply from battery for headlight.
Fuse No. 6	Capacity: 30 A Protected circuits: Voltage regulator, live loads.
Fuse No. 7	Capacity: 7.5 A Protected circuits: Live for high-beam light remote control, low-beam light remote control, stop light and start-up.
Fuse No. 8	Capacity: 7.5 A Protected circuits: Live for instrument panel lightning, horn, tail lights.
Fuse No. 9	Capacity: 7.5 A Protected circuits: Live for injection loads remote control, electric fan remote control,

immobilizer, injection electronic control unit.

Fuse No. 10

Capacity:7.5 A

Protected circuits:Live for turn indicators, antitheft device, instrument panel, fuel gauge.

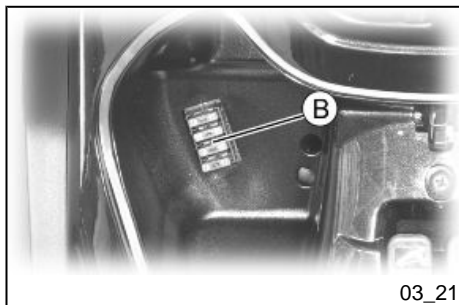
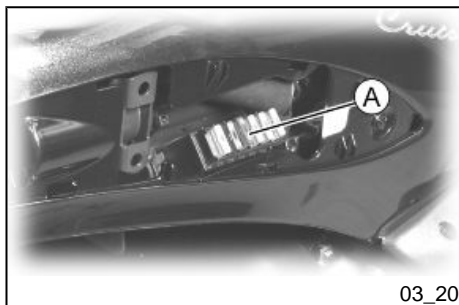

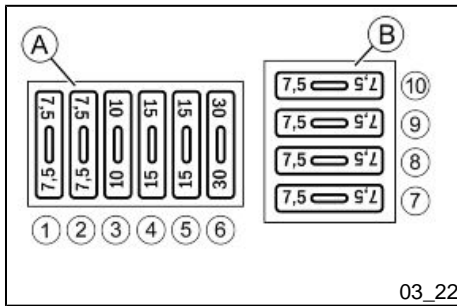

LIST OF BULBS

High-/low-beam bulb	Type: Halogen (H4) Quantity: 1 Power: 12V - 55/60W
---------------------	---

Front tail light bulb	Type: All glass Quantity: 1 Power: 12V - 5W
-----------------------	--

Turn indicator bulbs	Type: Spherical Quantity: 4 Power: 12V - 10W
----------------------	---

Rear tail light bulb	Type: All glass Quantity: 2
----------------------	--

Power: 12V - 3W

Stop light bulb

Type: Spherical

Quantity: 1

Power: 12V - 10W

Instrument panel lighting bulb

Type: All glass

Quantity: 5

Power: 12V - 1.2W

Helmet compartment light bulb

Type: Cylindrical

Quantity: 1

Power: 12V - 5W

License plate light bulb

Type: All glass

Quantity: 1

Power: 12V - 5W

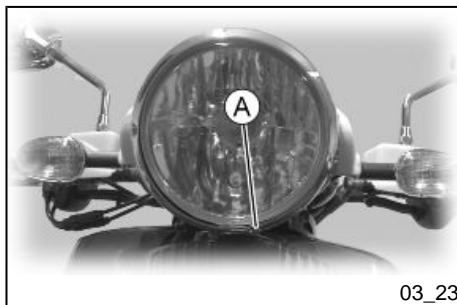

Frontlightgroup (03_23, 03_24)

To access the bulbs, undo the screw «A» and remove the headlight assembly collecting the shim washer and the washer.

To replace the high-/low-beam headlight bulb «B», detach the connector, remove the rubber protection, release the retaining clip and take out the bulb.

To replace the tail light bulb «C», take out the rubber bulb holder and slide off the bulb.

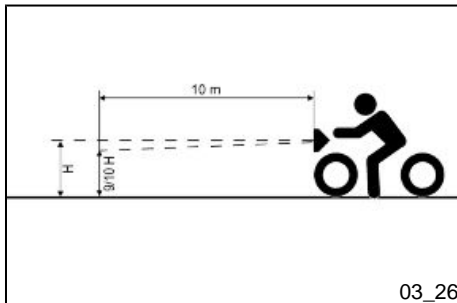
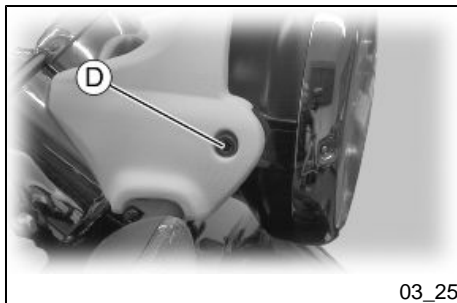
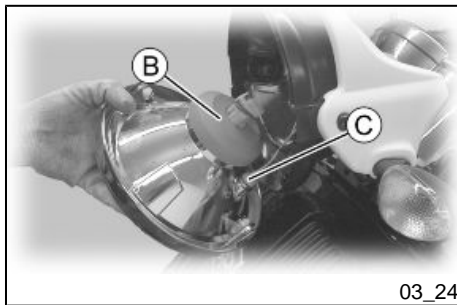

Headlightadjustment (03_25, 03_26, 03_27)

In order to carry out the vertical adjustment of the light beam:

1. Place the vehicle, in running order and with the tyres inflated to the prescribed pressure, on a flat surface 10 m away from a half-lit white screen, and make sure that the longitudinal axis of the scooter is perpendicular to the screen.
2. Turn on the headlight and check that the borderline of the beam projected on the screen is not higher than 9/10 or lower than 7/10 of the height of the centre of the headlight from the ground.
3. Otherwise, loosen the screws «D» and rotate the light until the optimal orientation is obtained.

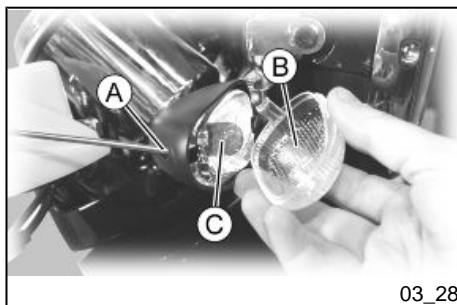
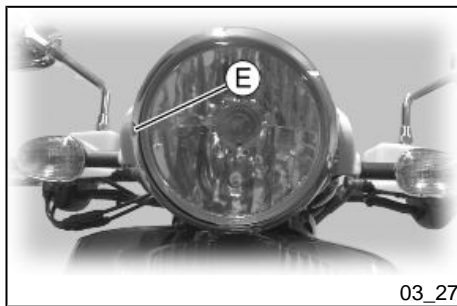

Frontdirectionindicators (03_28)

To replace the bulb:

1. Unscrew and remove the screw «A».
2. Remove the protective glass «B» with caution so as not to break the fitting tab.
3. Press the bulb «C» slightly and rotate it anticlockwise.
4. Take out the bulb from its fitting.

5. Fit a new bulb of equal type making sure the two guiding pins slide into their slots in the bulb holder.

Rearopticalunit (03_29, 03_30, 03_31, 03_32, 03_33)

To access the bulbs:

1. Remove the battery cover.
2. Remove the luggage rack plastic cover by acting on the screw «A» and unscrew the three fixing screws of the luggage rack.
3. Remove screw «B».
4. Remove side fairings by undoing screws «C» paying attention not to damage the retaining straps.
5. Remove both screws «B » and take out the rear light unit.

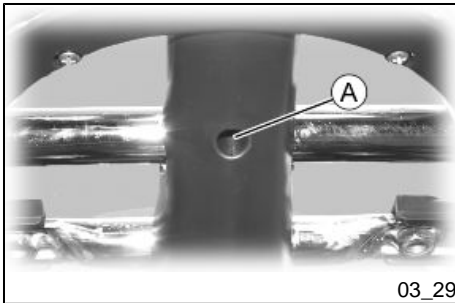

03_29

To replace the tail light bulbs «E», take out the rubber bulb holder from its fitting and slide off the bulb.

To replace turn indicator bulbs «F» and the stop light bulb «G», take out the bulb holder pressing the plastic tongues and turning the bulb anticlockwise.

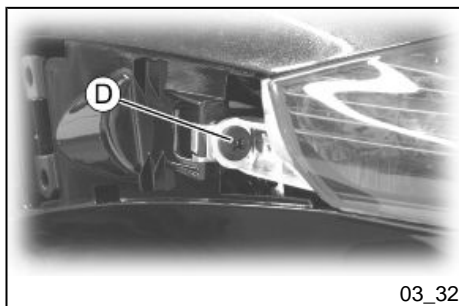
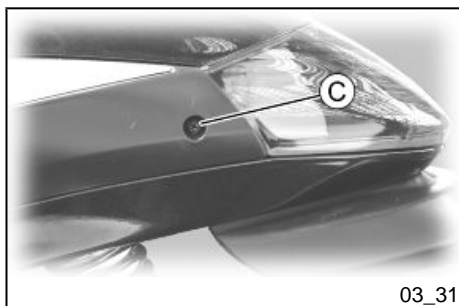
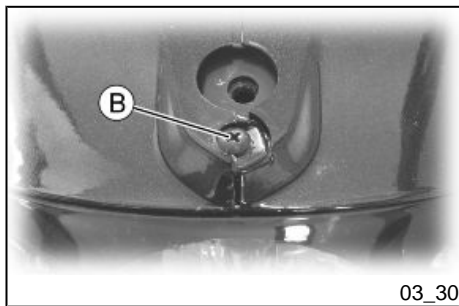

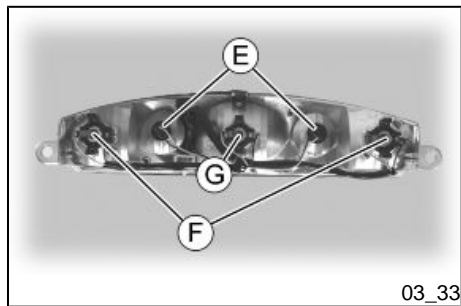

03_33

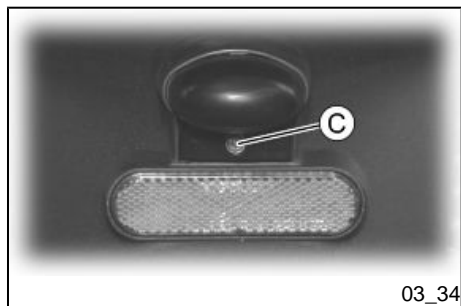

03_34

Numberplatelight (03_34)

Remove the screw «C», then take out the bulb holder.

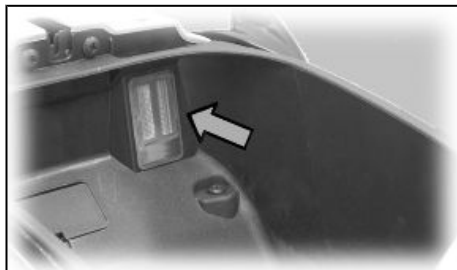

03_35

Helmetcompartmentlightingbulb (03_35)

Open the helmet compartment, take out the snap-on transparent glass and replace the bulb.



03_36

Rear-viewmirrors (03_36)

Adjust the mirrors by applying slight pressure to the side of the mirror to move it to the desired position.



03_37

Front and rear disc brake (03_37)

The brake disc and pad wear is automatically compensated, therefore it has no effect on the functioning of the front and rear brakes. For this reason it is not necessary to adjust the brakes. An excessively elastic brake lever stroke may indicate the presence of air in the braking circuit or a failure in the braking system. In this case, mainly due to the importance of brakes to guarantee safe riding conditions, the vehicle should be taken to an **Authorised Service Centre or Dealer**.

CAUTION



BRAKING SHOULD BEGIN AFTER ABOUT 1/3 OF THE BRAKE LEVER STROKE.

CAUTION



HAVE THE BRAKE PADS CHECKED BY THE DEALER ACCORDING TO THE CHECKS SPECIFIED IN THE SCHEDULED MAINTENANCE TABLE. HOWEVER, IN THE EVENT OF NOISES COMING FROM THE FRONT AND/OR REAR BRAKING SYSTEM DURING OPERATION, IT IS ADVISABLE TO HAVE THE BRAKING SYSTEM CHECKED BY AN AUTHORISED SERVICE CENTRE OR DEALER. AFTER REPLACING THE BRAKE PADS, DO NOT USE THE SCOOTER UNTIL YOU HAVE OPERATED THE BRAKE LEVER SEVERAL TIMES IN ORDER TO ALLOW THE PLUNGERS TO SETTLE AND THE LEVER STROKE TO BE SET TO THE CORRECT POSITION.

CAUTION



THE PRESENCE OF SAND, MUD, SNOW MIXED WITH SALT, ETC. ON THE ROAD, CAN DRASTICALLY REDUCE THE LIFE OF THE BRAKE PADS. IN ORDER TO AVOID THIS, WE RECOMMEND WASHING THE VEHICLE FREQUENTLY WHEN RIDING IN THESE ROAD CONDITIONS.

Puncture

The vehicle is equipped with Tubeless tyres (without inner tubes). In the event of a puncture, Tubeless tyres - unlike tyres with inner tubes - go flat very slowly, resulting in a greater steering safety. A flat tyre can be repaired with an emergency «inflate and repair» spray. For a final repair, take your vehicle to an **Authorised Service Centre or Dealer**. The replacement of a tyre involves removing the wheel in question. Take your vehicle to an **Authorised Service Centre or Dealer** for these operations.

CAUTION



TO USE THE "INFLATE AND REPAIR" SPRAY CAN PROPERLY, FOLLOW THE INSTRUCTIONS ON THE PACKAGING.

WARNING



THE WHEELS FITTED WITH TYRES SHOULD ALWAYS BE BALANCED. RIDING THE VEHICLE WITH VERY LOW TYRE PRESSURE OR WITH INCORRECTLY BALANCED TYRES CAN LEAD TO DANGEROUS STEERING VIBRATIONS.

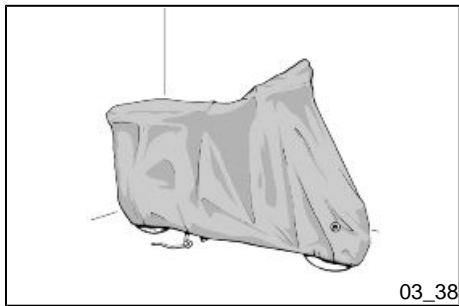

delveicolo (03_38)

The following operations are recommended:

1. Clean the scooter thoroughly and then cover it with a canvas;
2. With the engine off and the piston at the bottom dead centre position, remove the spark plug, and pour $1 \div 2 \text{ cm}^3$ of the recommended oil through its hole. Operate the starter button 1-2 times for roughly 1 second to turn the engine over slowly, then insert the spark plug again;
3. Ensure that the **fuel tank is at least half full (so that the fuel pump is fully covered)**; spread antirust grease on the uncoated metal parts; keep the wheels lifted above the ground by resting the chassis on two wooden wedges;
4. As regards the battery, follow the instructions in the «Battery» section.

Recommended products

eni i-Ride PG 5W-40

Synthetic based lubricant for high-performance four-stroke engines.
 JASO MA, MA2 - API SL - ACEA A3

Cleaningthevehicle

Use a low pressure jet of water to soften the caked dirt and mud deposited on the painted surfaces. Once softened, sponge off mud and dirt using a car body sponge soaked in a car body shampoo and water solution (2-4% of car shampoo in water). Then rinse with abundant water, and dry with a shammy cloth. Any polishing with silicon wax must always be preceded by washing

CAUTION



DETERGENTS CAN POLLUTE WATER. THE VEHICLE MUST BE WASHED AT A WASH STATION EQUIPPED WITH A SPECIAL WATER PURIFICATION SYSTEM.

WARNING

THE USE OF A HIGH-PRESSURE WATER JET IS STRONGLY DISCOURAGED FOR ANY ENGINE CLEANING OPERATION; HOWEVER, IF NO OTHER MEANS ARE AVAILABLE, IT IS THEN NECESSARY TO:

- **ONLY USE A FANLIKE SPRAY JET.**
- **DO NOT PLACE THE NOZZLE CLOSER THAN 60 CM.**
- **DO NOT USE WATER AT TEMPERATURES OVER 40°C.**
- **DO NOT USE HIGH-PRESSURE WATER JETS.**
- **DO NOT STEAM WASH.**
- **DO NOT AIM THE JET AT: THE CARBURETTOR, THE ELECTRIC CABLES, THE SLOT DIFFUSERS IN THE TRANSMISSION COVER AND THE SCROLL COVER.**

CAUTION

NEVER WASH THE SCOOTER IN DIRECT SUNLIGHT, ESPECIALLY IN SUMMER WHEN THE BODYWORK IS STILL HOT AS THE SHAMPOO COULD DAMAGE THE PAINTWORK IF IT DRIES BEFORE BEING RINSED OFF. NEVER USE CLOTHS SOAKED IN ALCOHOL, PETROL, DIESEL OIL OR KEROSENE FOR CLEANING THE PAINTED OR PLASTIC SURFACES, IN ORDER NOT TO DAMAGE THE LUSTRE FINISH OR ALTER THEIR MECHANICAL PROPERTIES. USING SILICONE-BASED WAX CAN DAMAGE THE PAINTED SURFACES, DEPENDING ON THE VEHICLE COLOUR (SATIN COLOURS). FOR FURTHER INFORMATION ON THIS MATTER, CONTACT AN AUTHORISED SERVICE CENTRE.

WARNING



IN ORDER TO MAINTAIN PROPER CLEANING AND BRILLIANCE OF THE MUFFLER, WE RECOMMEND THE USE OF A PRODUCT SPECIFICALLY FOR CHROME-PLATED SURFACES

USE A SPECIFIC PASTE, ORDERED UNDER CODE 602683M FROM OUR DEALER NETWORK, TO POLISH STAINLESS STEEL MUFFLERS.

STARTING FAILURE

Emergency switch in «OFF»	Set the switch back to «ON»
Fuse blown	Replace the blown fuse and have the scooter checked by an Authorised Service Centre.

STARTING DIFFICULTIES (SEE «STARTER PROBLEMS» SECTION)

Lack of fuel in tank.	Refuelling
Injection system fault	Contact an Authorised Service Centre
Fuel pump fault	Contact an Authorised Service Centre
Flat battery	Recharge the battery.

*** IMPORTANT: DO NOT USE THE SCOOTER TO THE COMPLETE EXHAUSTION OF FUEL; SHOULD THIS OCCUR, DO NOT ATTEMPT TO START THE ENGINE. TURN THE IGNITION KEY TO «OFF» AND TOP-UP THE FUEL TANK AS SOON AS POSSIBLE. FAILURE TO FOLLOW THESE GUIDELINES COULD DAMAGE THE FUEL PUMP AND/OR THE CATALYTIC CONVERTER.**

IGNITION PROBLEMS

Faulty spark plug	Contact an Authorised Service Centre
Faulty ignition / injection control unit. Due to the presence of high voltage, this check should only be carried out by an expert.	Contact an Authorised Service Centre

LACK OF COMPRESSION

Loose spark plug.	Screw in the spark plug tightly
Cylinder head loose, piston gas rings worn.	Contact an Authorised Service Centre
Valve stuck	Contact an Authorised Service Centre

HIGH CONSUMPTION AND LOW PERFORMANCE

Clogged or dirty air filter

Try to blow out with compressed air, otherwise replace the filter

INSUFFICIENT BRAKING

Greasy disc. Worn pads. Faulty braking system. Presence of air in the front and rear brake circuit.

Contact an **Authorised Service Centre**

INEFFICIENT SUSPENSION

Shock absorber fault, oil leak, end buffers damaged; shock absorber preloading incorrectly set

Contact an **Authorised Service Centre**

AUTOMATIC TRANSMISSION PROBLEMS

CVT rollers and/or drive belt damaged

Contact an **Authorised Service Centre**

BEVERLY Cruiser 250ie



PIAGGIO®



Chap. 04
Technicaldata

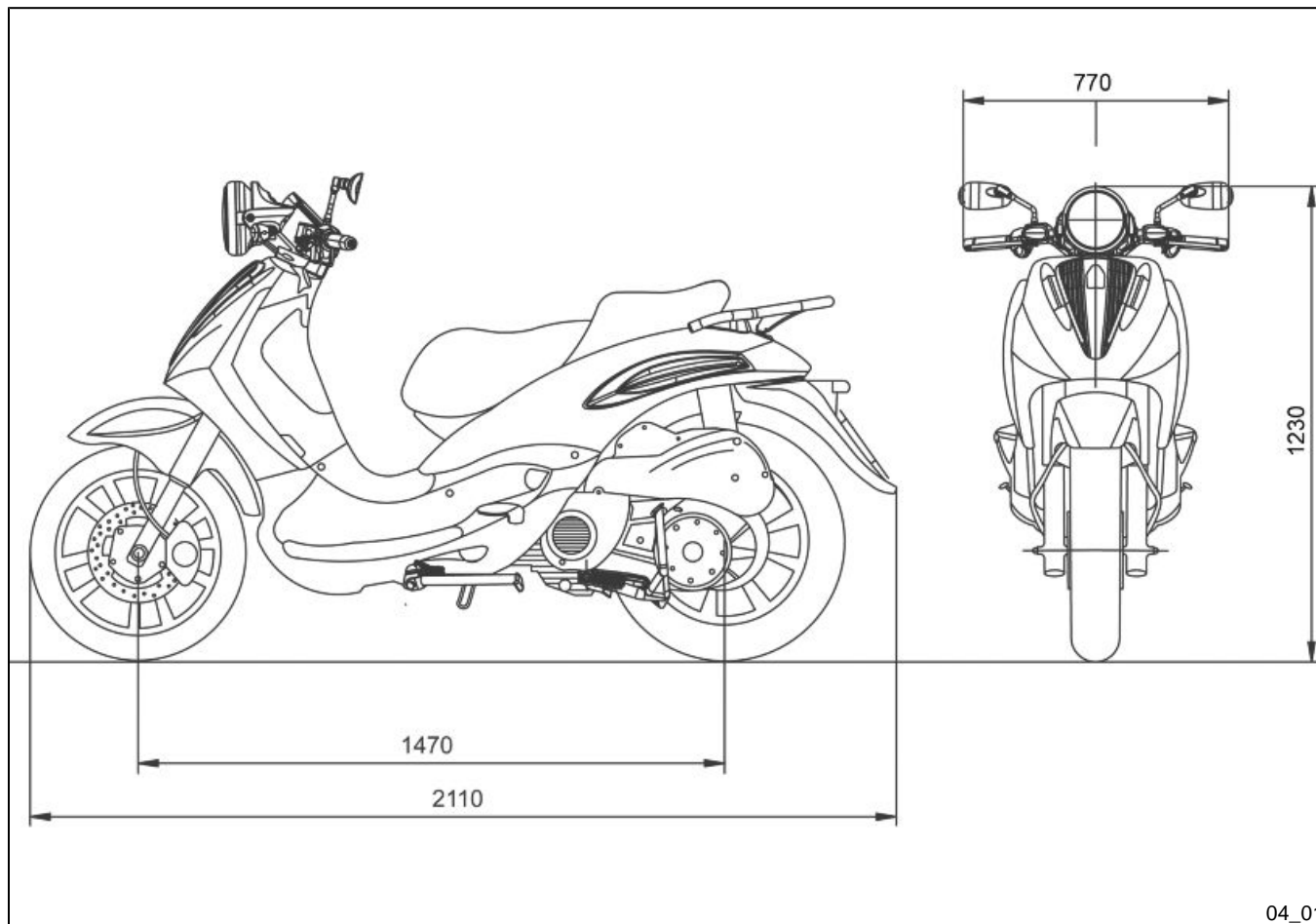

ENGINE TECHNICAL DATA

Type	Single-cylinder, 4-stroke
Engine capacity	244 cm ³
Bore x Stroke	72 x 60 mm
Compression ratio	11 ± 0.5 : 1
Engine idle speed	1,700 ± 100 rpm
Timing system	4 valves, single overhead camshaft, chain-driven.
Valve clearance	Intake: 0.10 mm Exhaust: 0.15 mm
MAX. Power	16.2 kW at 8,250 rpm
MAX. torque	20.2 Nm at 6,500 rpm
Transmission	CVT expandable pulley variator with torque server, V-belt, self-ventilating dry automatic centrifugal clutch and transmission housing with forced-circulation air cooling.
Final reduction gear	Gear reduction unit in oil bath.
Lubrication	Engine lubrication with lobe pump (inside crankcase), chain-driven, with double filter: mesh and paper.
Cooling	Forced coolant circulation system.
Starter	Electric

Ignition	Electronic inductive discharge ignition, high efficiency, with separate HV coil.
Ignition advance	α/N three-dimensional map managed by control unit
Spark plug	CHAMPION RG 4 PHP
Alternative spark plug	-
Fuel system	Electronic injection with \varnothing 32-mm throttle body and electric fuel pump.
Fuel	Unleaded petrol (95 RON)
Exhaust silencer	Absorption-type exhaust silencer with a 3-way catalytic converter and lambda probe.
Emissions compliance	EURO 3

VEHICLE TECHNICAL DATA

Chassis	Tubular and steel sheets.
Front suspension	Hydraulic telescopic fork with \varnothing 35-mm stem
Rear suspension	Two double-acting shock absorbers, adjustable to four positions at preloading.
Front brake	\varnothing 260-mm disc brake with hydraulic control activated by handlebar right-side lever.

Rear brake	Ø 260-mm disc brake with hydraulic control activated by handlebar left-side lever.
Wheel rim type	Light alloy wheel rims.
Front wheel rim	16" x 3.00
Rear rim	16 x 3.50"
Front tyre	Tubeless, 110/70 - 16" 52P
Rear tyre	Tubeless, 140/70 - 16" 65P
Front tyre pressure (with passenger)	2 bar (-)
Rear tyre pressure (with passenger)	2.5 bar (-)
Kerb weight	168 ± 5 kg
Maximum weight allowed	350 kg
Battery	12V-12Ah

CAPACITY

Engine oil	1.3 l
Transmission oil	250 cm ³
Cooling system fluid	1.75 l
Fuel tank (reserve)	~ 10 l (2 l)

Toolkit

One box-spanner; one lever for box-spanner; one twin screwdriver; one special wrench for adjusting rear shock absorbers. The tools are stored in the helmet compartment.

BEVERLY Cruiser 250ie



PIAGGIO®



Chap. 05
Spareparts and
accessories



Warnings (05_01)

WARNING



TO PREVENT ACCIDENTS AND TO GUARANTEE PROPER STABILITY, PERFORMANCE AND SAFETY, RIDE THE VEHICLE VERY CAREFULLY WHEN IT IS FITTED WITH ACCESSORIES OR WITH UNUSUAL LOADS.

WARNING



IT IS ALSO RECOMMENDED THAT ORIGINAL PIAGGIO SPARE PARTS BE USED, AS THESE ARE THE ONLY ONES OFFERING YOU THE SAME QUALITY GUARANTEE AS THOSE INITIALLY FITTED ON THE SCOOTER. THE USE OF NON-ORIGINAL SPARE PARTS RENDERS THE WARRANTY VOID.

WARNING



PIAGGIO MARKETS ITS OWN LINE OF ACCESSORIES THAT ARE RECOGNISED AND GUARANTEED FOR USE. IT IS THEREFORE ESSENTIAL TO CONTACT AN AUTHORISED DEALER OR SERVICE CENTRE IN ORDER TO CHOOSE AND FIT ACCESSORIES CORRECTLY. THE USE OF NON-ORIGINAL ACCESSORIES MAY AFFECT THE STABILITY AND OPERATION OF YOUR VEHICLE AND REDUCE SAFETY LEVELS WITH POTENTIAL RISKS FOR THE RIDER.

WARNING

NEVER RIDE THE SCOOTER EQUIPPED WITH ACCESSORIES (TOP BOX AND/OR WINDSHIELD) AT A SPEED HIGHER THAN 100 km/h.

THE SCOOTER CAN BE RIDDEN AT A HIGHER SPEED WITHOUT THE ACCESSORIES MENTIONED BEFORE WITHIN THE LIMITS ESTABLISHED BY LAW.

IF THERE ARE ANY NON-PIAGGIO ACCESSORIES INSTALLED, OR AN ABNORMAL LOAD, OR IF THE SCOOTER IS NOT IN A GENERALLY GOOD CONDITION, OR WHENEVER WEATHER CONDITIONS DEMAND IT, SPEED SHOULD BE FURTHER REDUCED.

WARNING

BE EXTREMELY CAREFUL WHEN INSTALLING AND REMOVING THE MECHANICAL ANTITHEFT DEVICE ON THE VEHICLE (U-SHAPED PADLOCK, DISC BLOCK, ETC.).

MAINLY NEAR THE BRAKE PIPES, TRANSMISSIONS AND/OR ELECTRIC CABLES, AN INCORRECT INSTALLATION OR REMOVAL OF THE ANTITHEFT DEVICE AS WELL AS LEAVING IT ON BEFORE STARTING THE VEHICLE CAN SERIOUSLY DAMAGE ITS COMPONENTS, COMPROMISE THE CORRECT FUNCTIONING OF THE VEHICLE AND USERS' SAFETY.

BEVERLY Cruiser 250ie



PIAGGIO®



**Chap. 06
Scheduled maintenance**



Scheduled servicing table (06_01)

Adequate maintenance is fundamental to ensuring long-lasting, optimum operation and performance of your vehicle.

To this end, a series of checks and maintenance operations (at the owner's expense) have been suggested, which are included in the summary table on the following page. Any minor faults should be reported without delay to an **Authorised Service Centre or Dealer** without waiting until the next scheduled service to solve it.

It is indispensable to have your vehicle serviced to the prescribed intervals of time, even if you have not reached the predicted mileage. Punctual vehicle servicing is necessary for the correct use of the guarantee. For all further information regarding the Guarantee application modes and the execution of the "Programmed Maintenance" refer to the "Guarantee Booklet".

SCHEDULED MAINTENANCE TABLE

km x 1,000	1	5	10	15	20	25	30	35	40	45	50	55	60
Roller bearing - Driven pulley			L		L		L		L		L		L
Safety fasteners	I		I				I				I		I
Spark plug					R				R				R
Driving belt			I		R		I		R		I		R
Throttle control	A		A		A		A		A		A		A
Air filter			C		C		C		C		C		C
Oil filter	R		R		R		R		R		R		R
Valve clearance					A				A				A
Electrical system and battery	I		I		I		I		I		I		I
Brake fluid *	I		I		I		I		I		I		I

km x 1,000	1	5	10	15	20	25	30	35	40	45	50	55	60
Coolant *	I		I		I		I		I		I		I
Engine oil	R	I	R	I	R	I	R	I	R	I	R	I	R
Hub oil	R		I		R		I		R		I		R
Brake pads	I	I	I	I	I	I	I	I	I	I	I	I	I
Sliding shoes / CVT rollers			R		R		R		R		R		R
Tyre pressure and wear	I		I		I		I		I		I		I
Vehicle road test	I		I		I		I		I		I		I
Suspension	I		I		I		I		I		I		I
Steering	A		A		A		A		A		A		A

I: CHECK AND CLEAN, ADJUST, LUBRICATE OR REPLACE IF NECESSARY.

C: CLEAN, R: REPLACE, A: ADJUST, L: LUBRICATE

** Replace every 2 years*

RECOMMENDED PRODUCTS TABLE

Product	Description	Specifications
AGIP GEAR SAE 80W-90	Lubricant for gearboxes and transmissions.	API GL-4
AGIP GP 330	Water repellent stringy calcium spray grease.	R.I.D./A.D.R. 2 10°b) 2 R.I.Na. 2.42 - I.A.T.A. 2 - I.M.D.G. class 2 UN 1950 Page 9022 EM 25-89
eni i-Ride PG 5W-40	Synthetic based lubricant for high-performance four-stroke engines.	JASO MA, MA2 - API SL - ACEA A3

Product	Description	Specifications
AGIP BRAKE 4	Brake fluid.	Synthetic fluid SAE J 1703 - FMVSS 116 - DOT 3/4 - ISO 4925 - CUNA NC 956 DOT 4
AGIP PERMANENT SPEZIAL	Ethylene glycol-based antifreeze fluid with organic inhibition additives. Red, ready to use.	ASTM D 3306 - ASTM D 4656 - ASTM D 4985 - CUNA NC 956-16
AGIP FILTER OIL	Special product for the treatment of foam filters.	-
AUTOSOL METAL POLISH	Silencer cleaning paste	Specific product for cleaning and polishing stainless steel mufflers.
eni i-Ride PG 5W-40	Synthetic based lubricant for high-performance four-stroke engines.	JASO MA, MA2 - API SL - ACEA A3
AGIP GREASE SM 2	Gray black smooth-textured lithium grease, containing molybdenum disulphide.	-
AGIP GREASE PV2	Ivory smooth-textured, slightly-stringy anhydrous calcium-base grease.	TL 9150 066, symbol NATO G 460

TABLE OF CONTENTS

B

Battery: 52

C

Checks: 28

F

Fuses: 54

I

Identification: 23

K

Keys: 16

M

Maintenance: 39

P

Puncture: 67

R

Refuelling: 28

S

Stand: 35

T

Toolkit: 78

Tyres: 45

V

Vehicle: 7



The descriptions and images in this publication are given for illustrative purposes only and are not binding. While the basic characteristics as described and illustrated in this booklet remain unchanged, Piaggio & C. S.p.A. reserves the right, at any time and without being required to update this publication beforehand, to make any changes to components, parts or accessories, which it considers necessary to improve the product or which are required for manufacturing or construction reasons.

Not all versions/models shown in this publication are available in all countries. The availability of each model should be checked at the official PIAGGIO sales network.

© Copyright 2012 - Piaggio & C. S.p.A. All rights reserved. Reproduction of this publication in whole or in part is prohibited.

Piaggio & C. S.p.A. Viale Rinaldo Piaggio, 25 - 56025 PONTEDERA (PI), Italy

www.piaggio.com