

PIAGGIO WOULD LIKE TO THANK YOU

for choosing one of its products. We have prepared this manual to help you to get the very best from your vehicle. Please read it carefully before riding the vehicle for the first time. It contains information, tips and precautions for using your vehicle. It also describes features, details and devices to assure you that you have made the right choice. We believe that if you follow our suggestions, you will soon get to know your new scooter and it will serve you well for a long time to come. This booklet forms an integral part of the vehicle; should the vehicle be sold, it must be transferred to the new owner.

Fly 50 2T



PIAGGIO®

The instructions given in this manual are intended to provide a clear, simple guide to using your vehicle; this booklet also details routine maintenance procedures and regular checks that should be carried out on the vehicle at an **authorised Dealer or Service Centre**. The booklet also contains instructions for simple repairs. Any operations not specifically described in this booklet require the use of special tools and/or particular technical knowledge: to carry out these operations, refer to any **authorised Dealer or Service Centres**.



Personal safety

Failure to completely observe these instructions will result in serious risk of personal injury.



Safeguarding the environment

Sections marked with this symbol indicate the correct use of the vehicle to prevent damaging the environment.



Vehicle intactness

The incomplete or non-observance of these regulations leads to the risk of serious damage to the vehicle and sometimes even the invalidity of the guarantee.

The signs that you see on this page are very important. They are used to highlight parts of the booklet that should be read with particular care. The different symbols are used to make each topic in the manual simple and quick to locate.

INDEX

VEHICLE	7	Checkingthebrakeoillevel.....	33
Dashboard.....	8	Battery.....	34
Clock.....	9	Checkingtheelectrolytelevel.....	35
Keyswitch.....	10	Long periods of inactivity.....	36
Lockingthesteeringwheel.....	10	Fuses.....	37
Releasingthesteeringwheel.....	10	Frontlightgroup.....	39
Switchdirectionindicators.....	11	Headlightadjustment.....	41
Hornbutton.....	11	Frontdirectionindicators.....	41
Lightswitch.....	11	Rearopticalunit.....	42
Start-upbutton.....	12	Rear-viewmirrors.....	42
Openingthesaddle.....	13	Idleadjustment.....	43
Keys.....	13	Frontdiscbrake.....	43
Identification.....	14	Reardrumbrake.....	44
Rearboxopening.....	14	Puncture.....	45
Bagclip.....	15	delveicolo.....	45
USE	17	Cleaningthevehicle.....	46
Checks.....	18	TECHNICALDATA	51
Refuelling.....	18	Toolkit.....	55
Tyrepressure.....	20	SPAREPARTSANDACCESSORIES	57
Runningin.....	21	Warnings.....	58
Startinguptheengine.....	21	SCHEDULEDMAINTENANCE	59
Difficultstart.....	22	Scheduledservicingtable.....	60
Stoppingtheengine.....	23		
Catalyticsilencer.....	24		
Automatictransmission.....	24		
Safedriving.....	25		
MAINTENANCE	27		
Huboillevel.....	28		
Tyres.....	29		
Sparkplugdismantlement.....	30		
Removingtheairfilter.....	31		
Secondaryairsystem.....	32		
Intakeplug.....	32		

Fly 50 2T



PIAGGIO®



**Chap. 01
Vehicle**

Dashboard (01_01)

A = Speedometer

B = Odometer

C = Fuel gauge

D = Front brake control lever

E = Turn indicator warning light

F = Mixer oil reserve warning light

G = High-beam warning light

H = Low fuel warning light

I = Low-beam/side lights warning light

L = High/low beam switch

M = Turn indicator switch

N = Horn button

P = Starter button

Q = Throttle grip

R = Rear brake control lever

S = Digital clock

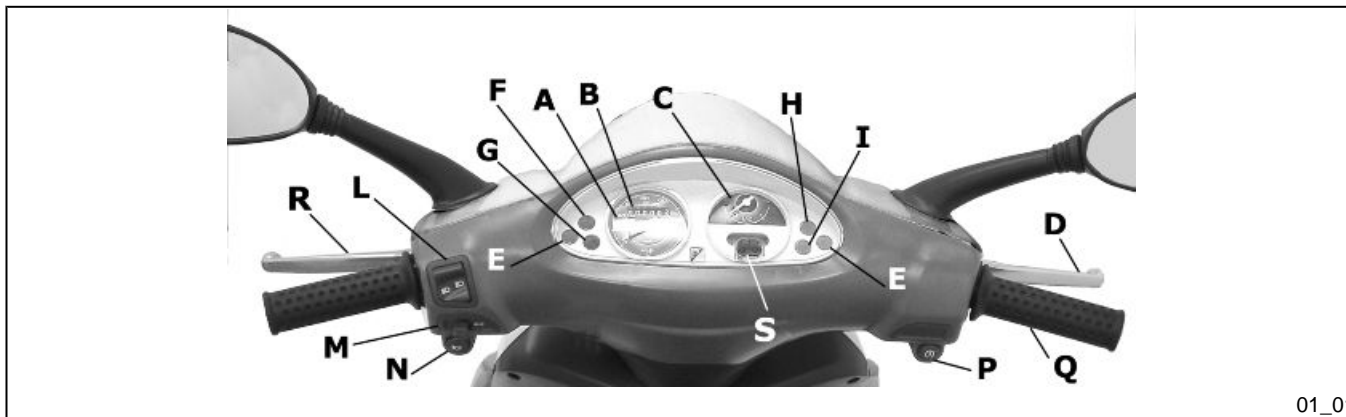

01_01

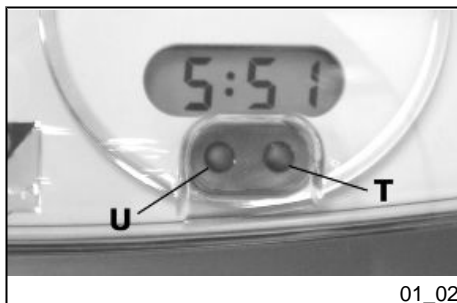

01_02

Clock (01_02)

Hours and minutes are displayed in a 1 to 12, AM or PM, format on the instrument panel.

Operating the function selection switch «T» month, day and seconds can be seen besides hours and minutes. In order to adjust the above mentioned functions, operate button «U». The digital clock is powered by a battery (battery life is about 2 years); lift the whole instrument panel to replace the battery. It is advisable to take your vehicle to an **Authorised Service Centre** for this operation.

WARNING



DEAD BATTERIES ARE HARMFUL TO THE ENVIRONMENT. THEY MUST DISPOSED OF IN SUITABLE CONTAINERS AS PRESCRIBED BY THE REGULATIONS IN FORCE.



Keyswitch (01_03)

LOCK = Ignition disabled, extractable key, steering lock engaged front glove-box locked.

OFF = Ignition disabled, extractable key, steering lock disengaged, front glove-box unlocked.

ON = Ready to start position, anti-theft device disabled, non-extractable key, glove-box unlocked.

Locking the steering wheel

Turn the handlebar to the left (as far as it will go), turn the key to «**LOCK**» and remove the key.

CAUTION



DO NOT TURN THE KEY TO «LOCK» OR «KEY OFF» WHILE RIDING.

Releasing the steering wheel

Reinsert the key and turn it to «**OFF**».

CAUTION



DO NOT TURN THE KEY TO «LOCK» OR «KEY OFF» WHILE RIDING.

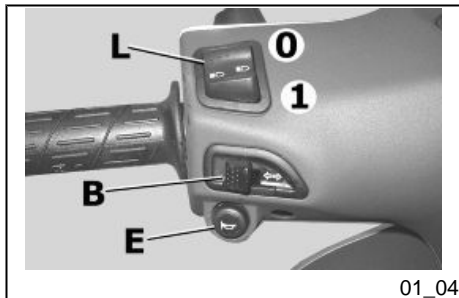

01_04

Switchdirectionindicators (01_04)

To set the left turn indicators flashing, move lever «B» to the left; to set the right turn indicators flashing, move it to the right. The lever automatically returns to the central position and the indicators remain on. To turn the indicators off, press the lever towards the switch.

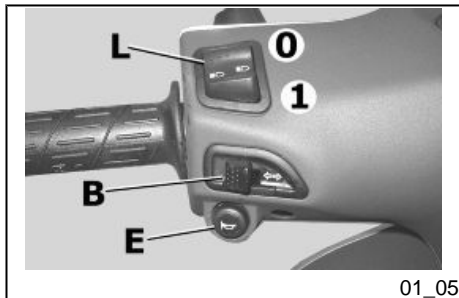

01_05

Hornbutton (01_05)

Horn button «E»

Lightswitch (01_06)

0 = Low-beam and tail light

1 = High-beam and tail light

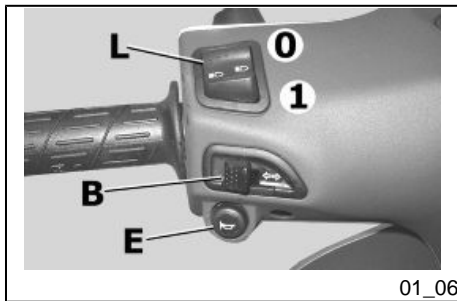
**CAUTION**

DO NOT PLACE, TRANSPORT OBJECTS AND/OR CLOTHES OVER THE FRONT HEADLIGHT ASSEMBLY, WHEN THE HEADLIGHT IS TURNED ON OR OFF. FAILURE TO FOLLOW THIS PRECAUTION MAY CAUSE OVERHEATING AND THE SUBSEQUENT FUSION OF THE GLASS.

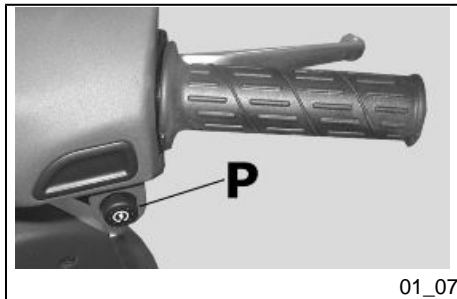
**Start-upbutton (01_07)**

To start the engine, press the starter button, «P», after pulling either one of the two brake levers.



Openingthesaddle (01_08)

Insert the key into the saddle lock «A», turn it anticlockwise and tip the saddle forward.



Keys (01_09)

The vehicle is supplied with two keys (one spare) which serve to start the engine and unlock the saddle compartment. The keys are accompanied by a tag marked with the identification code to be quoted when ordering duplicates.

WARNING

WE RECOMMEND KEEPING THE DUPLICATE KEY TOGETHER WITH ITS CODE IN A SAFE PLACE AND NOT ON THE VEHICLE



Identification (01_10, 01_11)

The identification numbers consist of a prefix stamped on the chassis and on the engine, followed by a number. They must be quoted when ordering spare parts. We recommend that you check that the prefix and chassis number stamped on the vehicle correspond with those in the vehicle documents.

CAUTION



PLEASE REMIND THAT ALTERING IDENTIFICATION REGISTRATION NUMBERS CAN LEAD TO SERIOUS PENAL SANCTIONS (IMPOUNDING OF THE VEHICLE, ETC.).

Rear top box opening

Turn the key to «OFF». Then press it. When the key is set to «LOCK», the glove-box is locked.

Bagclip (01_12)

To use the retractable bag hook «**B**» located at the front end of the saddle, pull it forward lightly.

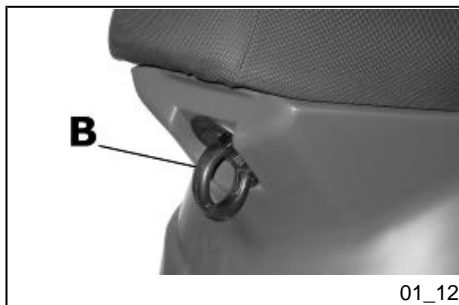

Fly 50 2T



PIAGGIO®



Chap. 02
Use

Checks

Before using the vehicle, check:

1. That the petrol tank and the oil reservoir are full.
2. Rear hub oil level.
3. That the tyres are properly inflated.
4. The correct functioning of headlights, rear light and turn indicators.
5. The correct functioning of front and rear brakes.
6. The fluid level in the brake pump reservoir.

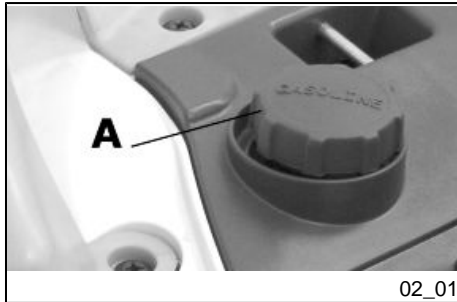

02_01

Refuelling (02_01, 02_02)

Fill fuel tank «**A**» with unleaded gasoline. Minimum octane rating method 95.. The rider is informed when fuel is low by the fuel warning light on the instrument panel (see section «The dashboard»).

Fill engine oil tank «**B**» with new recommended engine oil. The rider is informed when engine oil is low by the oil warning light on the instrument panel (see section «The dashboard»).

After this warning light goes on, at the next refuel (do not travel more than 150 km with the warning light on). When the oil light comes on you are advised to top up the oil tank. When the key is turned to «**ON**» the oil warning light illuminates for a few seconds, indicating the light and oil warning circuit are working correctly.

If the warning light fails to illuminate, it is faulty. **Contact an Authorized Piaggio Service Center.**

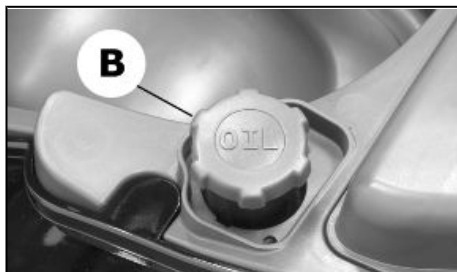

02_02

CAUTION

SHUT OFF THE ENGINE BEFORE REFUELLING WITH PETROL. PETROL IS HIGHLY FLAMMABLE. DO NOT LET PETROL SPILL FROM THE TANK OR WHILE REFUELLING

CAUTION

DO NOT BRING NAKED FLAMES OR CIGARETTES NEAR THE MOUTH OF THE FUEL TANK: FIRE HAZARD. ALSO AVOID INHALING HARMFUL VAPOURS.



IMPORTANT: NEVER EMPTY THE MIXER OIL RESERVOIR.

CAUTION

THE USE OF OILS AND SPARK PLUGS OTHER THAN THOSE RECOMMENDED CAN SHORTEN THE LIFE OF THE ENGINE.

Recommended products

eni i-Ride PG 2t

*Synthetic based lubricant for low smoke 2-stroke engines and additives.
API TC - JASO FC - ISO-L-EGD*

Characteristic

oil mixer tank

Plastic, capacity ~ 1.2 l

Topping up mixer oil reservoir

Topping up oil reservoir: 0.5 ÷ 0.7 l

Fuel tank capacity

~ 7.2 litres (of which 1.5 l is reserve)

Tyrepressure**CAUTION**

TYRE PRESSURE SHOULD BE CHECKED WHEN TYRES ARE COLD. INCORRECT TYRE PRESSURE CAUSES ABNORMAL TYRE WEAR AND MAKES RIDING DANGEROUS.

TYRES MUST BE REPLACED WHEN THE TREAD REACHES THE WEAR LIMITS SET FORTH BY LAW.

Characteristic**Front tyre pressure**

1.8 bar

Rear tyre pressure

2 bar

Rear wheel pressure (rider and passenger):

2.3 bar

Runningin (02_03)

WARNING



DURING THE FIRST 1000 KM DO NOT RIDE THE VEHICLE OVER 80% OF ITS MAXIMUM SPEED. AVOID TWISTING THE THROTTLE GRIP FULLY OR KEEPING A CONSTANT SPEED ALONG LONG SECTIONS OF ROAD. AFTER THE FIRST 1000 KM, GRADUALLY INCREASE SPEED UNTIL REACHING THE MAXIMUM PERFORMANCE.

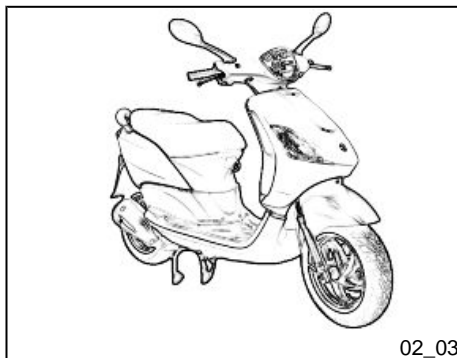

02_03

Startinguptheengine (02_04)

The vehicle is fitted with automatic transmission with a regulator and centrifugal clutch. Therefore always start the engine with the throttle at idle speed; to start-off from stationary position, progressively twist the throttle grip.

The vehicle is equipped with a fuel valve and a starter which switch on automatically as soon as the engine is started.

In order to start the engine, it is necessary to pull either the rear brake lever «**B**» or the front brake lever «**C**», before pressing the starting button, «**A**», so as to disengage the safety switches.

1: Put the scooter on its stand «**E**»; check that the rear wheel is off the ground.

2: Keep the throttle closed.

3: Insert the key into the ignition switch, «**D**», and turn to the **ON** position.

4: Push the starter button «**A**» after pulling the rear brake lever «**B**» or the front brake lever «**C**».

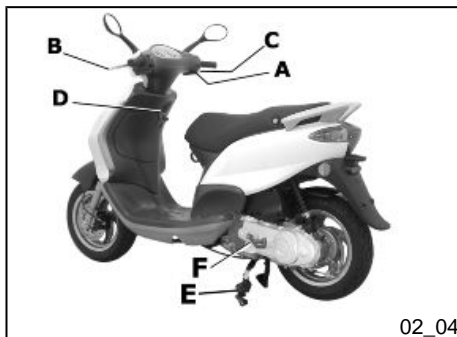

02_04

CAUTION



DO NOT CARRY OUT THESE OPERATIONS IN CLOSED AREAS SINCE EXHAUST GASES ARE TOXIC.

CAUTION



DUE TO THE HIGH TEMPERATURES THE CATALYTIC CONVERTER CAN REACH, ALWAYS TAKE CARE, WHEN PARKING THE VEHICLE, THAT THE EXHAUST DOES NOT COME INTO CONTACT WITH FLAMMABLE MATERIALS, TO AVOID SERIOUS BURNS.

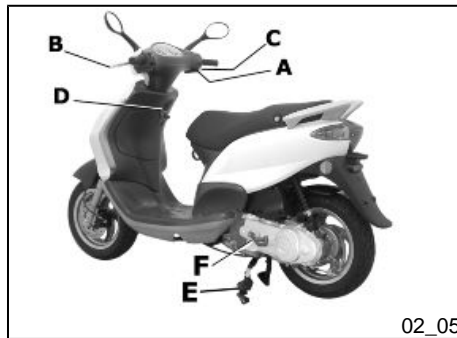

Difficultstartup (02_05)

If there is a problem you can follow the instructions below:

- 1. Engine flooded.** Place the vehicle on its centre stand and check that the rear wheel is off the ground. Open the throttle fully and press the starter button for five seconds and then stop for five seconds. If the engine does not start after a few attempts, let the engine sit for a few minutes and then repeat the above operations. In any case do not operate the starter motor longer than 20" in an attempt to start the engine.
- 2. Battery or starter motor inefficiency.** Put the scooter on its stand "E"; make sure that the rear wheel is off the ground, turn the key switch «D» to «ON» and use the kick-starter «F».
- 3. Empty fuel tank.** After refuelling the scooter, start the engine by pressing the starter button «A» with the throttle at a minimum to provide maximum aspiration for the tap. If the vehicle fails to start even after carrying out the steps described above, contact an **Authorised Service Centre**.

CAUTION

ALWAYS PLACE THE VEHICLE ON ITS STAND BEFORE KICK STARTING.

WARNING

TAMPERING MAY CAUSE SERIOUS ENGINE MALFUNCTION.

Stoppingtheengine (02_06)

Stop acceleration, then turn the key switch «D» to «OFF » to stop the engine (extractable key).

CAUTION

DUE TO THE HIGH TEMPERATURES THE CATALYTIC CONVERTER CAN REACH, ALWAYS TAKE CARE, WHEN PARKING THE VEHICLE, THAT THE EXHAUST DOES NOT COME INTO CONTACT WITH FLAMMABLE MATERIALS, TO AVOID SERIOUS BURNS.

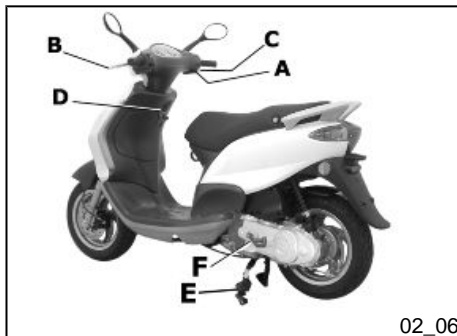

Catalyticsilencer

CAUTION



TAMPERING WITH THE CATALYTIC SILENCER MAY CAUSE SEVERE DAMAGE TO THE ENGINE.

CAUTION



WHEN PARKING THE VEHICLE, DUE TO THE HIGH TEMPERATURES THE CATALYTIC CONVERTER CAN REACH, ALWAYS BE CAREFUL THAT THE MUFFLER DOES NOT COME INTO CONTACT WITH FLAMMABLE MATERIALS, TO AVOID SERIOUS BURNS.

CAUTION



DO NOT SHUT OFF THE ENGINE WHILE THE VEHICLE IS MOVING. UNBURNED FUEL COULD ENTER THE CATALYTIC CONVERTER AND BURN, CAUSING THE CONVERTER TO OVERHEAT AND POSSIBLY DESTROYING IT.

Automatictransmission

To ensure simple, pleasurable riding, the vehicle is equipped with automatic transmission with regulator and centrifugal clutch. The system is designed to give the best possible performance in terms of both acceleration and consumption, on level ground and uphill, thanks to the adjustments made to engine speed and transmitted torque. If you have to stop on an uphill slope (traffic lights, traffic jam, etc.) only use the brake to keep the vehicle still, leaving the motor running at idling speed. Using the motor to keep the vehicle still can cause the clutch to overheat. This problem is due to the

friction of the clutch parts on the clutch bell. It is therefore recommended to avoid conditions of prolonged clutch slippage leading to clutch overheating (for example, as well as the situation described above, riding uphill fully laden on steep slopes or starting off on slopes greater than 25%, etc.):

1. Do not continue riding in such conditions.
2. Let the clutch cool down with the motor at idling speed for a few minutes

Safedriving

WARNING



SOME SIMPLE TIPS ARE PROVIDED BELOW WHICH WILL ENABLE YOU TO USE YOUR VEHICLE ON A DAILY BASIS MORE EASILY AND SAFELY.

<

Your ability and your knowledge of the vehicle form the basis of safe riding. We recommend trying out the vehicle in traffic-free zones to get to know your vehicle completely.

ALWAYS DRIVE WITHIN YOUR LIMITS

1. Before riding off, remember to put on your helmet and fasten it correctly.
2. Reduce speed and ride cautiously on uneven roads.
3. Remember that after riding on a long stretch of wet road without using the brakes, the braking effect is initially lower. Under these conditions, it is a good idea to operate the brakes from time to time.
4. Do not brake hard on a wet surface, on dirt tracks or on any slippery road surface.

5. If you have to brake, use both brakes in order to divide the braking action between both wheels.
6. Avoid starting off by mounting the vehicle while it is still resting on its stand. In any case, the rear wheel should not be turning when it comes into contact with the ground, in order to avoid abrupt departures.
7. If the vehicle is used on roads covered with sand, mud, snow mixed with salt, etc., clean the brake disc frequently with mild detergent in order to prevent abrasive substances from building up within the holes, which can result in early wear of the brake pads.
8. Any elaboration that modifies the vehicle's performances, such as tampering with original structural parts is strictly forbidden by law, and renders the vehicle not conforming to the approved type and therefor dangerous to ride.

CAUTION

RIDING UNDER THE INFLUENCE OF ALCOHOL, DRUGS OR CERTAIN MEDICINES CAN BE EXTREMELY DANGEROUS FOR ONESELF AND FOR OTHERS.

CAUTION

ANY ELABORATION THAT MODIFIES THE VEHICLE'S PERFORMANCES, SUCH AS TAMPERING WITH ORIGINAL STRUCTURAL PARTS IS STRICTLY FORBIDDEN BY LAW, AND RENDERS THE VEHICLE NO LONGER CONFORMING TO THE APPROVED TYPE AND DANGEROUS FOR RIDING.

Fly 50 2T



PIAGGIO®



**Chap. 03
Maintenance**

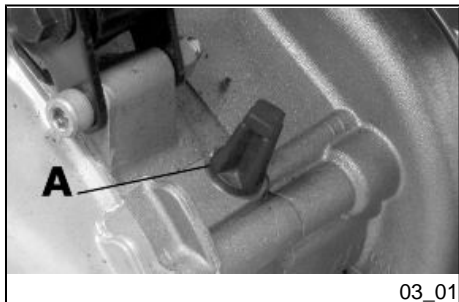

03_01

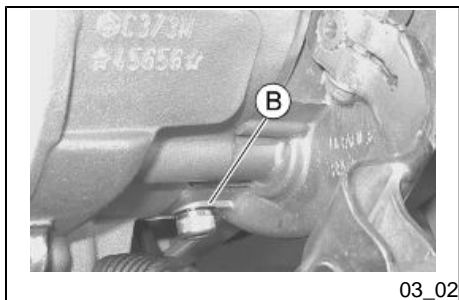

03_02

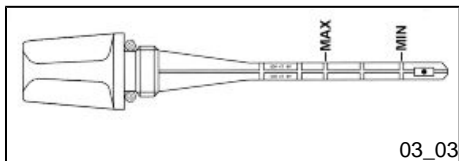

03_03

Huboillevel (03_01, 03_02, 03_03)

To check the hub oil level, proceed as follows:

1. Park the scooter on level ground and rest it on its stand.
2. Unscrew the oil dipstick «A», dry it with a clean cloth and then reinsert it, **screwing it fully into place**;
3. Unscrew the dipstick again and check that the oil level just reaches the **2nd notch from the bottom**;
4. Screw the dipstick back into place completely.

The screw «B» is the hub oil drainage plug.

CAUTION



RUNNING THE ENGINE WITH INSUFFICIENT LUBRICATION OR WITH THE INADEQUATE LUBRICANTS ACCELERATES WEAR AND TEAR OF THE MOVING PARTS AND CAN CAUSE IRRETRIEVABLE DAMAGE.

CAUTION



USED OILS CONTAIN SUBSTANCES HARMFUL TO THE ENVIRONMENT. FOR OIL REPLACEMENT, CONTACT AN AUTHORISED SERVICE CENTRE WHICH IS EQUIPPED TO DISPOSE OF USED OILS IN AN ENVIRONMENTALLY FRIENDLY AND LEGAL WAY.

N.B.

THE NOTCHES ON THE HUB OIL LEVEL DIPSTICK, EXCEPT THE ONE INDICATING THE MAXIMUM AND MINIMUM LEVEL, REFER TO OTHER MODELS BY THE MANUFACTURER AND HAVE NO SPECIFIC FUNCTION FOR THIS MODEL.

Recommended products

AGIP GEAR SAE 80W-90

Lubricant for gearboxes and transmissions.
API GL-4

Characteristic

Rear hub oil

Quantity: approx. 85 cc

Tyres (03_04)

Periodically check the inflation pressure of each tyre (when cold).

Tyres are fitted with wear indicators; tyres should be replaced as soon as these indicators become visible on the tyre tread. Also check that the tyres do not show signs of splitting at the sides or irregular tread wear; If this occurs, go to an authorised workshop or at least a workshop adequately equipped to remove and refit tyres.

CAUTION



TYRE PRESSURE SHOULD BE CHECKED WHEN TYRES ARE COLD. INCORRECT TYRE PRESSURE CAUSES ABNORMAL TYRE WEAR AND MAKES RIDING DANGEROUS.

TYRES MUST BE REPLACED WHEN THE TREAD REACHES THE WEAR LIMITS SET FORTH BY LAW.

Characteristic

Front tyre pressure

1.8 bar

Rear tyre pressure

2 bar

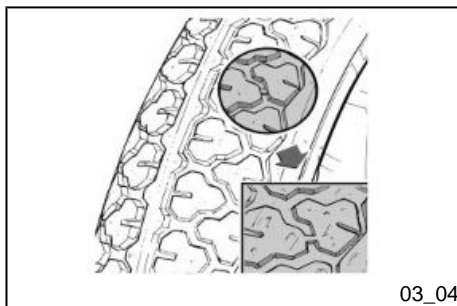

Rear wheel pressure (rider and passenger):

2.3 bar

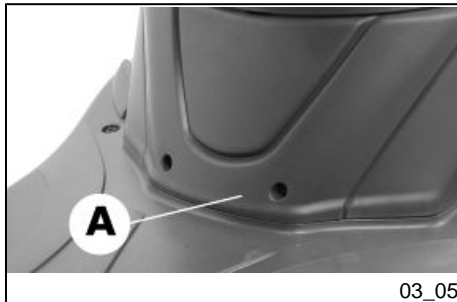

03_05

Sparkplugdismantlement (03_05, 03_06)

After loosening the fixing screws, remove door «A». Detach the spark plug cap and remove the spark plug using the box-spanner provided. To refit the spark plug, drive it in by hand and with the correct inclination, then tighten using the box-spanner. When refitting the door, follow the removal operations in the reverse order, minding the top tooth on the central cover.

CAUTION

FOLLOW THESE PROCEDURES VERY CAREFULLY TO AVOID ANY SEVERE DAMAGE THAT MAY BE CAUSED BY THE VERY POWERFUL IGNITION SYSTEM.

CAUTION

THE SPARK PLUG MUST BE REMOVED WHEN THE ENGINE IS COLD. USING IGNITION ELECTRONIC CENTRAL UNITS OR SPARK PLUGS OTHER THAN THE TYPES PRESCRIBED (SEE «TECHNICAL DATA» SECTION) CAN CAUSE SERIOUS DAMAGE TO THE ENGINE.

Characteristic**recommended spark plug:**

CHAMPION RN3C

Electrode gap

03_06

0.6 ÷ 0.7 mm

Removing the air filter (03_07, 03_08)

After removing the spark plug access door, remove the side fairing loosening the 3 fixing screws «A». Remove the air-box cover «D» after loosening the 5 fixing screws «C», and then extract the filter. Wash with soap, then dry with compressed air and hence soak in a 50% oil-petrol mixture. Squeeze, let dry and refit.

CAUTION



IN CASE OF RIDING ON DUSTY ROADS IT IS ADVISABLE TO CLEAN THE AIR FILTER MORE FREQUENTLY THAN INDICATED IN THE RELEVANT CHAPTER ON SCHEDULED MAINTENANCE.

Recommended products

AGIP FILTER OIL

Special product for the treatment of foam filters.

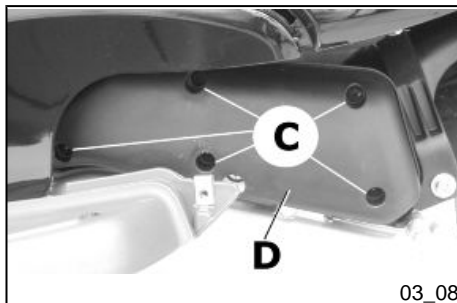
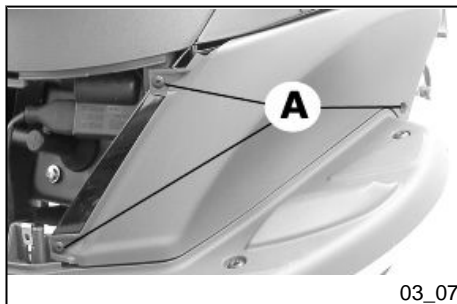

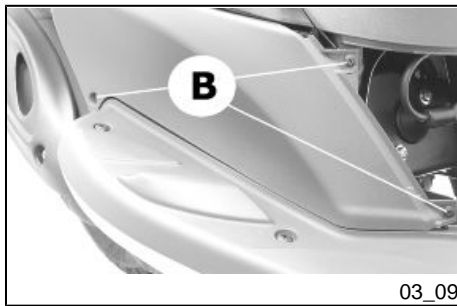

Secondary air system (03_09, 03_10)

After removing the spark plug cap, remove the RHS fairing, by loosening the three fixing screws «B» shown in the figure.

Remove the SAS aluminium cover fixing screws «A». Detach the metal hose from its rubber housing on the cover, without detaching it from the cover/bellow. Hence remove plate and plastic cover, extract the sponge and wash it with soap. Dry with compressed air before refitting, ensuring to correctly positioning the plate in the housing machined on the plastic and aluminium covers. Whenever removing the part, always replace the O-ring located on the special housing on the cover.

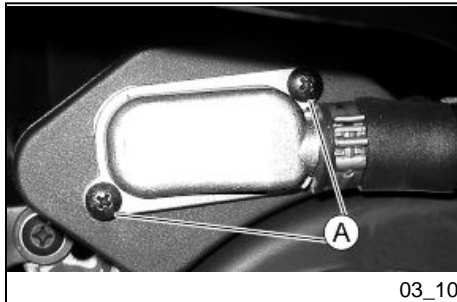

Intake plug (03_11)

Remove the cap of the transmission cover operating on the corresponding release slots with a plain slot screwdriver. Wash the sponge in water and soap without removing it from its seat.

Dry it with compressed air before refitting it taking care to do so at the correct angle.

CAUTION

WARNING!

SHOULD THERE BE ANY PROBLEMS WHEN ADJUSTING IDLE SPEED, IT MAY BE NECESSARY TO ADJUST EXHAUST GASES (CO) TOO. TURN TO AN AUTHORISED PIAGGIO SERVICE CENTRE TO CARRY OUT THESE OPERATIONS.

Checking the brake oil level (03_12, 03_13)

The brake fluid reservoir is equipped with a sight glass «A» made of transparent material; the quantity of liquid contained in the sight glass indicates the level of liquid in the reservoir.

When the sight glass «A» is full, the level inside the reservoir exceeds the MIN level; when it is partially full, the level drops to the MIN level; when it is fully empty, the level of fluid in the reservoir is below the MIN level.

The brake fluid level may fall due to wear on the brake pads. In case the pad wear is below the minimum mark, contact an **Authorised Service Centre** to have the braking system thoroughly checked. If you need to top up the level, follow the steps listed below. Unscrew the 2 screws «B», remove the reservoir cap «C» and pour in the required quantity of fluid (the brake fluid level must be above minimum). Place the handlebar in the riding position and pay attention not to tilt the vehicle in order to keep the brake fluid reservoir in horizontal position when checking the fluid level.

CAUTION



TOP-UPS SHOULD ONLY BE CARRIED OUT WITH DOT4 CLASSIFIED BRAKE FLUID.

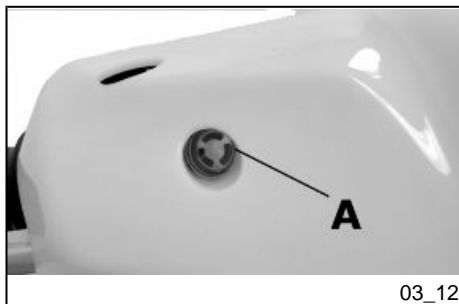

03_12

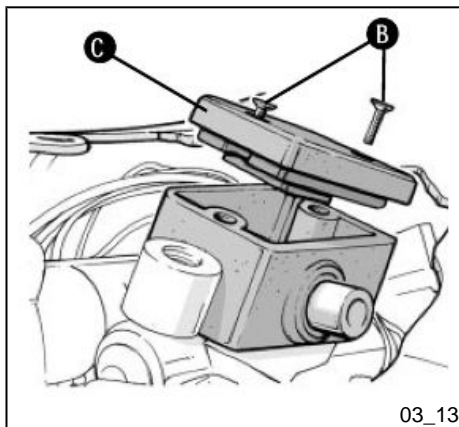

03_13

WARNING

IN NORMAL CLIMATIC CONDITIONS IT IS ADVISABLE TO REPLACE THE ABOVE-MENTIONED FLUID EVERY 2 YEAR. NEVER USE BRAKE FLUID CONTAINED IN CONTAINERS WHICH ARE ALREADY OPEN OR PARTIALLY USED.

CAUTION

THE BRAKING CIRCUIT FLUID IS HIGHLY CORROSIVE. THEREFORE, WHEN TOPPING UP, AVOID LETTING IT COME INTO CONTACT WITH THE PAINTED PARTS OF THE VEHICLE. THE BRAKING CIRCUIT FLUID IS HYGROSCOPIC, THAT IS, IT ABSORBS HUMIDITY FROM THE SURROUNDING AIR. IF MOISTURE CONTAINED IN THE BRAKE FLUID EXCEEDS A CERTAIN VALUE, THIS WILL RESULT IN INEFFICIENT BRAKING.

**Battery (03_14)**

Lift the saddle forward to access the battery then remove access door to the battery by unscrewing the star-shaped screws as shown in the picture.

The battery is the electrical device that requires the most frequent attention and the most thorough maintenance.

WARNING

USED BATTERIES ARE HARMFUL FOR THE ENVIRONMENT. COLLECTION AND DISPOSAL SHOULD BE CARRIED OUT IN COMPLIANCE WITH REGULATIONS IN FORCE.

CAUTION

ELECTROLYTE CONTAINS SULPHURIC ACID: AVOID CONTACT WITH EYES, SKIN AND CLOTHES. IN CASE OF ACCIDENTAL CONTACT, RINSE WITH ABUNDANT WATER AND CONSULT A DOCTOR.

CAUTION

IN ORDER TO AVOID DAMAGING THE ELECTRICAL SYSTEM, NEVER DISCONNECT THE WIRING WHILE THE ENGINE IS RUNNING. DO NOT TIP THE VEHICLE TOO MUCH IN ORDER TO AVOID DANGEROUS LEAKAGE OF THE BATTERY ELECTROLYTE.

Checkingtheelectrolytelevel

The electrolyte level, which should be checked regularly, must always be at the maximum level. To reach this level, use only distilled water. Should it become necessary to top up the battery with water too frequently, check the vehicle's electrical system because the battery is being overloaded, causing it to lose power quickly.

CAUTION

ELECTROLYTE CONTAINS SULPHURIC ACID: AVOID CONTACT WITH EYES, SKIN AND CLOTHES. IN CASE OF ACCIDENTAL CONTACT, RINSE WITH ABUNDANT WATER AND CONSULT A DOCTOR.

Long periods of inactivity

Battery performance will be poor if the vehicle is not used for a long time. This is the result of the natural phenomenon of battery discharging, and may be due to residual absorption by vehicle components with constant power consumption. Poor battery performance may also be due to environmental conditions and the cleanliness of the poles. In order to avoid difficult starts and/or irreversible damage to the battery, follow any of these steps:

- **At least once a month** start the engine and run it slightly above idle speed for 10-15 minutes. This keeps all the engine components, as well as the battery, in good working order.

- Take your vehicle to a garage (as indicated in the «Vehicle not used for extended periods» section) to have the battery removed. Have the battery cleaned, charged fully and stored in a dry, ventilated place. Recharge **at least once every two months**.

N.B.

THE BATTERY MUST BE CHARGED WITH A CURRENT EQUAL TO 1/10 OF THE RATED CAPACITY OF THE BATTERY AND FOR NOT LONGER THAN 10 HOURS. CONTACT AN AUTHORISED SERVICE CENTRE TO CARRY OUT THIS OPERATION SAFELY. WHEN REFITTING THE BATTERY MAKE SURE THE LEADS ARE CORRECTLY CONNECTED TO THE TERMINALS.

WARNING



DO NOT DISCONNECT THE BATTERY CABLES WITH THE ENGINE RUNNING, THIS CAN CAUSE IRREPARABLE DAMAGE TO THE VEHICLE'S ELECTRONIC CONTROL UNIT.

WARNING

USED BATTERIES ARE HARMFUL FOR THE ENVIRONMENT. COLLECTION AND DISPOSAL SHOULD BE CARRIED OUT IN COMPLIANCE WITH REGULATIONS IN FORCE.

Fuses (03_15)

The electrical system is protected by a plug fuse «B» located to the left of the battery compartment. The ignition system, headlight and the rear light are not fuse-protected. Before replacing a blown fuse, find and solve the problem that caused it to blow. Do not substitute the fuse with any alternative form of conductor

CAUTION

IN ORDER TO AVOID DAMAGING THE ELECTRICAL SYSTEM, NEVER DISCONNECT THE WIRING WHILE THE ENGINE IS RUNNING. DO NOT TIP THE VEHICLE TOO MUCH IN ORDER TO AVOID DANGEROUS LEAKAGE OF THE BATTERY ELECTROLYTE.

Electric characteristic**Fuse**

Fuse value: 7.5A

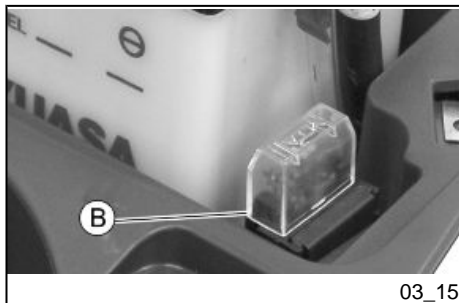

LIGHT BULBS TABLE

High/low beam light bulb	Type: Spherical Power: 12V 35/35W Quantity: 1
Front side light bulb	Type: All glass Power: 12V 5W Quantity: 1
Front turn indicator light bulb	Type: Spherical Power: 12V - 10W Quantity: 1 RHS + 1 LHS
Rear turn indicator light bulb	Type: Spherical Power: 12V - 10W Quantity: 1 RHS + 1 LHS
Stop and tail light bulb	Type: Spherical Power: 12V 21/5W Quantity: 1
12V - 2W warning light bulbs	Type: All glass Function: Turn indicators Quantity: 2
Pilot light bulbs 12V - 1,2W	Type: BAYONET

Function: Lights, high beams,
reserve level, reserve oil mixer

Quantity: 4

Instrument panel lighting bulbs

Type: All glass

Power: 12V 1.2W

Quantity: 3

Frontlightgroup (03_16, 03_17)

To access the headlight bulbs, remove the front of the handlebar cover, as follows:

- 1) Remove the rear-view mirrors; for this operation follow the instructions described and illustrated in the «Rear-view mirrors» section.
- 2) Unscrew the 3 screws holding the handlebar cover. The front central one «B» and the rear 2 «C». Once this is done, the handlebar cover can be removed.
- 3) Remove the handlebar cover to access the headlight and the bulbs.

N.B.

IF MISTING IS NOTICED ON THE INSIDE OF THE HEADLAMP GLASS, THIS DOES NOT INDICATE A FAULT AND IS ATTRIBUTABLE TO HUMIDITY AND/OR TO LOW TEMPERATURES.

THE PHENOMENON SHOULD QUICKLY DISAPPEAR WHEN THE LIGHT IS SWITCHED ON.

THE PRESENCE OF DROPS OF WATER, ON THE OTHER HAND, COULD INDICATE THAT WATER IS INFILTRATING. CONTACT THE AFTER-SALES SERVICE NETWORK.

Electric characteristic

Bulbs

1 12V35/35W bulb for high- and low-beam light

1 12V-5W bulb for side light

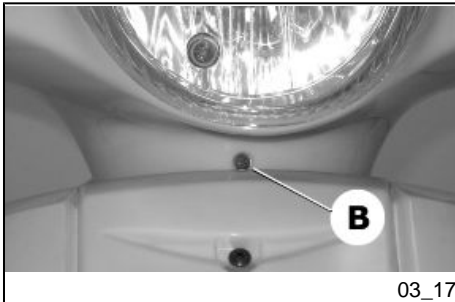
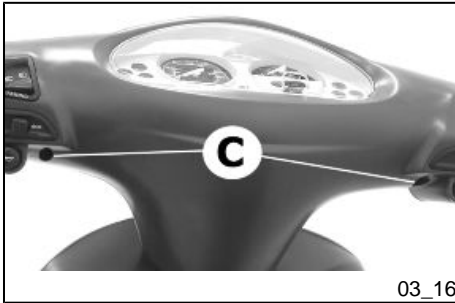

CAUTION



DO NOT PLACE, TRANSPORT OBJECTS AND/OR CLOTHES OVER THE FRONT HEADLIGHT ASSEMBLY, WHEN THE HEADLIGHT IS TURNED ON OR OFF. FAILURE TO FOLLOW THIS PRECAUTION MAY CAUSE OVERHEATING AND THE SUBSEQUENT FUSION OF THE GLASS.

Headlightadjustment (03_18, 03_19)

Proceed as follows:

1. Place the vehicle in running order and with the tyres inflated to the prescribed pressure, on a flat surface 10 m away from a white screen situated in a shaded area, making sure that the longitudinal axis of the vehicle is perpendicular to the screen;
2. Turn on the headlight and check that the borderline of the projected light beam on the screen is no higher than $9/10$ or lower than $7/10$ of the distance from the ground to the centre of the vehicle's headlamp;
3. If otherwise, adjust the right headlight with screw «A».

N.B.

THE ABOVE PROCEDURE COMPLIES WITH THE EUROPEAN STANDARDS REGARDING MAXIMUM AND MINIMUM HEIGHT OF LIGHT BEAMS. REFER TO THE STATUTORY REGULATIONS IN FORCE IN EVERY COUNTRY WHERE THE VEHICLE IS USED.

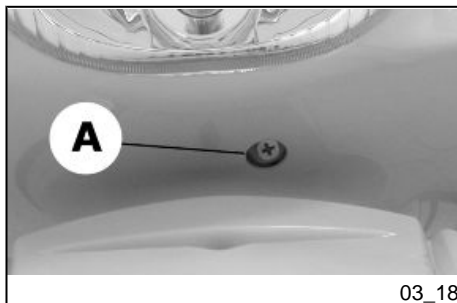

03_18

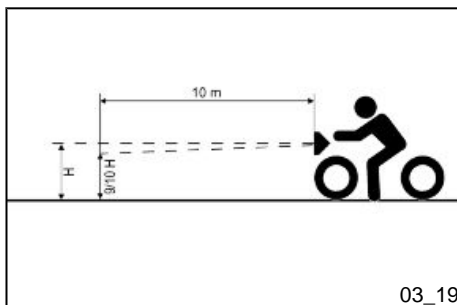

03_19

Frontdirectionindicators (03_20)

In order to replace the front turn indicator bulbs remove the light taking off the retaining screws, then remove the bulb holder form its support; gently turn the bulb around 30° and remove it. Follow the process in reverse order to refit.

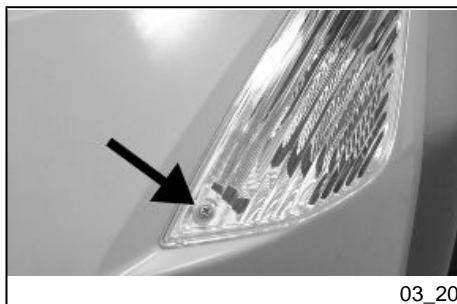

03_20

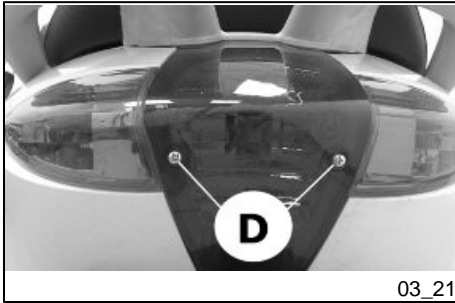

03_21

Rearopticalunit (03_21)

In order to reach the rear light bulb, remove the 2 «D» retaining screws. Doing so it is possible to access also the turn indicator bulbs. Gently push and turn the bulb about 30° and then remove it. To refit follow the same steps but in reverse order.

N.B.

IF MISTING IS NOTICED ON THE INSIDE OF THE HEADLAMP GLASS, THIS DOES NOT INDICATE A FAULT AND IS ATTRIBUTABLE TO HUMIDITY AND/OR TO LOW TEMPERATURES.

THE PHENOMENON SHOULD QUICKLY DISAPPEAR WHEN THE LIGHT IS SWITCHED ON.

THE PRESENCE OF DROPS OF WATER, ON THE OTHER HAND, COULD INDICATE THAT WATER IS INFILTRATING. CONTACT THE AFTER-SALES SERVICE NETWORK.

Rear-viewmirrors (03_22)

The mirrors can be set to the desired position by adjusting the mirror frame.

To remove the rear-view mirror rotate the rear-view mirror support rod clockwise.



03_22

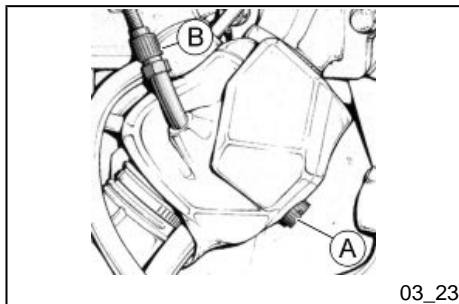

Idle adjustment (03_23)

The idle speed is adjusted by means of the idle speed adjuster screw «A» located on the carburettor.

To do this, proceed as shown in the diagram. Turn the register for adjusting the clearance of the throttle control transmission «B», then replace the rubber protection cap.

Adjust the idle speed with the rear wheel off the ground (vehicle on stand) and with a warm engine. Turn the knob-type head screw in or out until the engine idles smoothly (around 1700÷1900 rpm.), i.e. **without the rear wheel being moved by the engine.**

If adjustment still proves difficult, contact an **Authorised Piaggio Service Centre** to have the level of **CO when idling fixed** (carbon monoxide emissions).

CAUTION



WHEN ADJUSTING IDLE SPEED, BE CAREFUL NOT TO TOUCH HOT PARTS OF THE ENGINE TO AVOID BURNS.

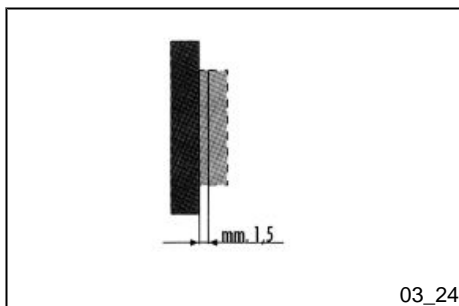

Front disc brake (03_24)

The brake disc and pad wear is automatically compensated, therefore it has no effect on the functioning of the front and rear brakes. For this reason it is not necessary to adjust the brakes. An excessively elastic brake lever stroke may indicate the presence of air in the braking circuit or an irregular brake operation. In this case, particularly considering the importance of the brakes in terms of safety, it is strongly recommended that you take the vehicle to an **Authorised Service Centre** as soon as possible for the appropriate checks.

WARNING

CHECK BRAKE PADS FOR WEAR ON A REGULAR BASIS (AS INDICATED IN THE SCHEDULE MAINTENANCE TABLES). IF THE THICKNESS OF ONE OR BOTH PADS IS IN THE REGION OF 1.5 MM, BOTH PADS MUST BE CHANGED. IT IS RECOMMENDED TO CARRY OUT THIS OPERATION AT AN AUTHORISED SERVICE CENTRE AS SOON AS POSSIBLE.

AFTER FITTING NEW BRAKE PADS DO NOT USE THE VEHICLE UNTIL YOU HAVE ACTIVATED THE BRAKE LEVER REPEATEDLY TO POSITION THE PADS AND RESTORE THE LEVER STROKE TO ITS CORRECT POSITION.

CAUTION

BRAKING SHOULD BEGIN AFTER ABOUT 1/3 OF THE BRAKE LEVER STROKE.

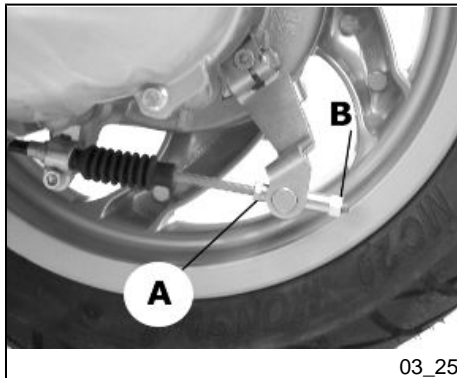
**Rear drum brake (03_25)**

Operate adjusting nut «B» and loosen lock nut «A» shown in the figure. Note that when the throttle is in idle **the wheel should rotate free**. After the adjustment, screw lock nut «A».

CAUTION

BRAKING SHOULD BEGIN AFTER ABOUT 1/3 OF THE BRAKE LEVER STROKE.

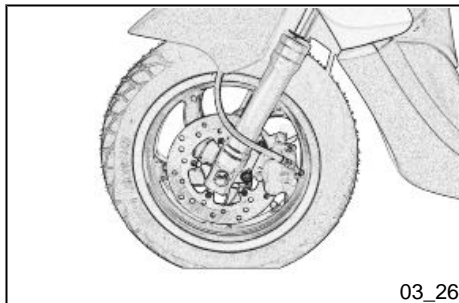

03_26

Puncture (03_26)

The vehicle is equipped with Tubeless tyres. When there is a puncture, Tubeless tyres - unlike tyres with inner tubes - go flat very slowly. This offers greater riding safety. A tyre that goes flat very slowly can be repaired with an "Inflate and Repair" spray. Tyres should be later fully repaired or replaced at an **Authorised Service Centre**.



03_27

delveicolo (03_27)

We recommend carrying out the following operations:

1. General cleaning of the vehicle.
2. With the engine off and the piston at the bottom dead centre position, **remove the spark plug**, and pour 1-2 cm³ of recommended oil through its hole. Press the engine start pedal 3 or 4 times letting the engine perform a few revolutions slowly, then replace the spark plug.

3. Drain up all the vehicle fuel; spread antirust grease on the uncoated metal parts; keep the wheels off the ground, by resting the chassis on two wooden wedges.
4. For the battery, follow the procedures described in the «Battery» section.
5. Drain the petrol from the carburettor float chamber through the bleed cap.

Recommended products

eni i-Ride PG 5W-40

Synthetic based lubricant for high-performance four-stroke engines.

JASO MA, MA2 - API SL - ACEA A3

Cleaningthevehicle

Use a low pressure jet of water to soften the caked dirt and mud deposited on the painted surfaces. Once softened, sponge off mud and dirt using a car body sponge soaked in a car body shampoo and water solution (2-4% of car shampoo in water). Then rinse with abundant water, and dry with a shammy cloth. For the engine exterior, use petrol, a brush and clean cloths. Petrol can damage paintwork. Remember that any polishing with silicone wax must always be preceded by washing.

WARNING



To avoid the appearance of oxidations, wash the vehicle every time it is used in certain areas or in special conditions of:

- **Environmental / seasonal conditions:** use of salt, de-icer chemical products on the road in winter.
- **Air pollution:** city and/or industrial areas.
- **Salinity and humidity of the atmosphere:** marine areas, hot and wet weather.

WARNING

- Prevent deposits from remaining on the bodywork, industrial and pollutant residual dust, tar spots, dead insects, bird droppings, etc.
- Do not park the vehicle under the trees. In some seasons, in fact, residues, resins, fruits or leaves may fall from the trees, containing chemicals that are harmful to the paintwork.

CAUTION

DETERGENTS POLLUTE WATER. THEREFORE THE VEHICLE SHOULD BE WASHED IN AN AREA EQUIPPED FOR THE COLLECTION AND PURIFICATION OF THE LIQUIDS USED.

WARNING

NEVER WASH THE VEHICLE UNDER DIRECT SUNLIGHT, ESPECIALLY IN SUMMER WHEN THE BODYWORK IS STILL HOT, AS THE CAR SHAMPOO MAY DRY BEFORE BEING RINSED OFF, AND COULD DAMAGE THE PAINTWORK. NEVER USE RAGS SOAKED IN PETROL OR DIESEL OIL TO CLEAN THE PAINTED OR PLASTIC SURFACES, IN ORDER TO PREVENT THEM LOSING THEIR SHINE AND MECHANICAL CHARACTERISTICS.

WARNING

WHEN WASHING THE ENGINE WITH A HIGH-PRESSURE WATER JET:

- **ONLY USE FAN SPRAY JETS.**

- DO NOT PLACE THE NOZZLE CLOSER THAN 60 CM.
- DO NOT USE WATER AT TEMPERATURES OVER 40° C.
- DO NOT DIRECT THE JETS DIRECTLY TO CARBURETTOR, WIRINGS, SLOT DIFFUSERS ON THE TRANSMISSION COVER AND SCROLL COVER.

DIFFICULT STARTING

No fuel in tank	Refuel
Filters, jets or carburettor body dirty or clogged.	Contact an Authorised Service Centre.
Insufficient battery charge	Kick-start. Recharge the battery.

IGNITION PROBLEMS

No spark from spark plug. Due to the presence of high voltage, this check should only be carried out by an expert.	Check that the electrodes are properly adjusted (0.7÷ 0.8 mm). Check that the electrodes are clean (use pure petrol and a metal brush or an emery cloth). Check the spark plug insulator: Replace the spark plug if the insulator is cracked or broken. If the spark plug is in good conditions, contact an Authorised Service Centre.
--	---

LACK OF COMPRESSION

Spark plug loose. Loose cylinder head, worn piston retaining rings.	Contact an Authorised Service Centre .
---	---

HIGH CONSUMPTION AND LOW PERFORMANCE

Air filter blocked or dirty.	Clean with water and shampoo and impregnate with petrol and specific oil («Air filter removal» section)
------------------------------	---

INEFFICIENT BRAKING

Oil on drum or disc. Worn Pads/Shoes	Contact an Authorised Service Centre
--------------------------------------	---

incorrect rear brake adjustment	Adjust
---------------------------------	--------

INEFFICIENT SUSPENSION

Oil leak; worn limit switch bumpers; worn shock absorber attachment points	Contact an Authorised Service Centre
--	---

AUTOMATIC TRANSMISSION PROBLEMS

Deteriorated roller housing or belt.	Contact an Authorised Service Centre .
--------------------------------------	---

INCREASED EXHAUST NOISE

Deterioration of the SAS system and/or of the tab	Contact an Authorised Service Centre .
---	---

STAND DOES NOT RETURN TO POSITION

Presence of dirt	Clean and grease
------------------	------------------

STARTER LEVER DOES NOT RETURN TO CORRECT POSITION

Presence of dirt	Clean and grease
------------------	------------------

Fly 50 2T



PIAGGIO®



Chap. 04
Technicaldata

TECHNICAL SPECIFICATIONS

Engine	Two-stroke, single cylinder Piaggio Hi-PER2
Cubic capacity	49.4 cc
Fuel tank capacity	~ 7.2 litres (of which 1.5 l is reserve)
Bore x stroke	40 X 39.3 mm
Compression ratio	10,3:1
Length	1880 mm
Width	735 mm
Maximum height	1150 mm
Wheelbase	1340 mm
Fuel	Unleaded petrol
Start-up	Electrical and kick starter
Lubrication	With blend and variable oil variable according to the engine revolutions and the throttle valve opening by means of a pump controlled by the driving shaft with toothed belt.
Cooling	Forced-circulation air cooling.
Transmission	Automatic variator CVT with torque server.
Clutch	Automatic centrifugal dry clutch

Frame	Tubular steel frame with sheet metal reinforcements
Front suspension	Telescopic mechanical fork, 76mm travel.
Rear suspension	Single hydraulic shock absorber, 72.5-mm travel
Front brake	Disc brake (Ø 200 mm) with hydraulic control (lever on the far right of the handlebar) and floating calliper.
Rear brake	Ø 140mm drum brake
Front wheel rim	Die-cast aluminium alloy; 3.50 x 12"
Rear wheel rim	Die-cast aluminium alloy: 3.00"x12"
Front tyre	Tubeless 120/70-12"
Rear tyre	Tubeless 120/70 - 12"
Dry weight	97 Kg
Type approval	Euro 2

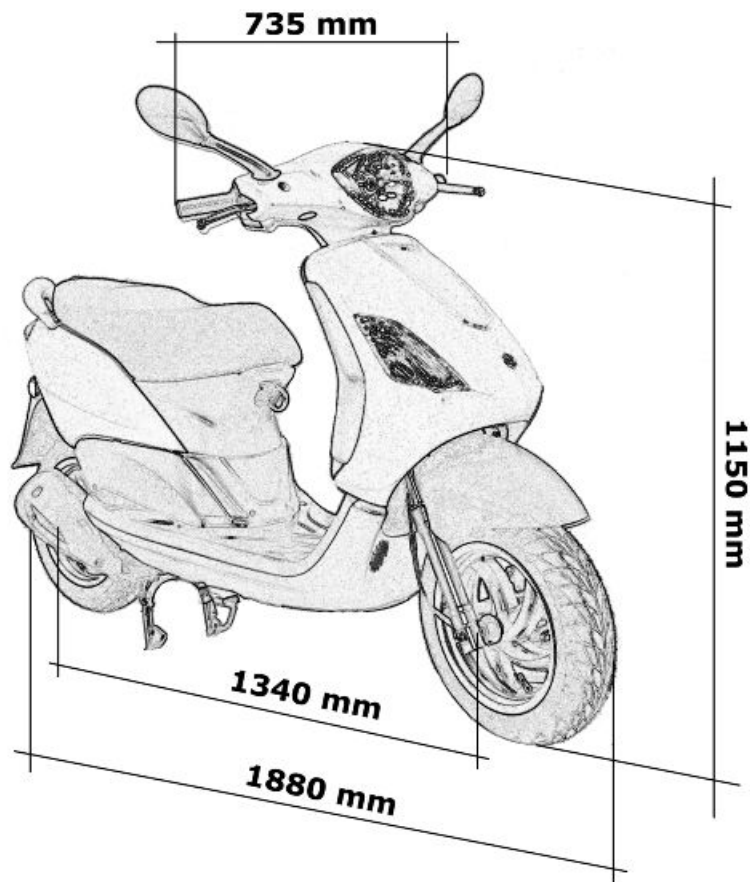

Toolkit

Wrenches: one 13-21mm box-spanner; lever for box-spanner; twin screwdriver. The tools are located under the seat in an appropriate container.

Fly 50 2T



PIAGGIO®



**Chap. 05
Spareparts and
accessories**



05_01

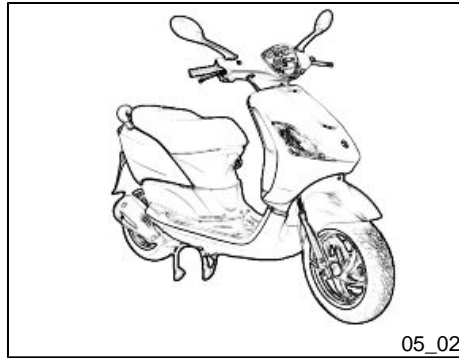

05_02

Warnings (05_01, 05_02)

WARNING



IT IS RECOMMENDED THAT "ORIGINAL PIAGGIO SPARE PARTS" BE USED, AS THESE ARE THE ONLY ONES OFFERING YOU THE SAME QUALITY ASSURANCE AS THOSE INITIALLY FITTED ON THE VEHICLE.

IT SHOULD BE REMEMBERED THAT USING NON-ORIGINAL SPARE PARTS CAUSES YOUR WARRANTY RIGHTS TO EXPIRE.

WARNING



PIAGGIO MARKETS ITS OWN LINE OF ACCESSORIES THAT ARE RECOGNISED AND GUARANTEED FOR USE. IT IS THEREFORE ESSENTIAL TO CONTACT AN AUTHORISED DEALER OR SERVICE CENTRE IN ORDER TO CHOOSE AND FIT ACCESSORIES CORRECTLY. THE USE OF NON-ORIGINAL ACCESSORIES MAY AFFECT THE STABILITY AND OPERATION OF YOUR VEHICLE AND REDUCE SAFETY LEVELS WITH POTENTIAL RISKS FOR THE RIDER.

Fly 50 2T



PIAGGIO®



Chap. 06
Scheduled maintenance



06_01

Scheduled servicing table (06_01)

Adequate maintenance is fundamental to ensuring long-lasting, optimum operation and performance of your vehicle.

To this end, a series of checks and maintenance operations (at the owner's expense) have been suggested, which are included in the summary table on the following page. Any minor faults should be reported without delay to an **Authorised Service Centre or Dealer** without waiting until the next scheduled service to solve it.

It is indispensable to have your vehicle serviced to the prescribed intervals of time, even if you have not reached the predicted mileage. Punctual vehicle servicing is necessary for the correct use of the guarantee. For any further information concerning Warranty procedures and 'Scheduled Maintenance', please refer to the 'Warranty Booklet'.

MAINTENANCE TABLE

km x 1,000	1	5	10	15	20	25	30	35	40	45	50	55	60
Safety fasteners	I		I		I		I		I		I		I
Spark plug		I	R	I	R	I	R	I	R	I	R	I	R
Drive belt			I	R	I		R		I	R	I		R
Mixer belt					R				R				R
Throttle control - mixer	A	A	A	A	A	A	A	A	A	A	A	A	A
Air filter		C	C	C	C	C	C	C	C	C	C	C	C
SAS filter			I	C	I		C		I	C	I		C
Electrical system and battery	I	I	I	I	I	I	I	I	I	I	I	I	I
Cylinder ventilation system					I				I				
Brake levers	L	L	L	L	L	L	L	L	L	L	L	L	L

km x 1,000	1	5	10	15	20	25	30	35	40	45	50	55	60
Brake fluid **	I	I	I	I	I	I	I	I	I	I	I	I	I
Mixer	I	I	I	I	I	I	I	I	I	I	I	I	I
Mixer oil*	I	I	I	I	I	I	I	I	I	I	I	I	I
Hub oil	R	I	R	I	R	I	R	I	R	I	R	I	R
Headlight direction adjustment			A		A		A		A		A		A
Brake Pads/Shoes	I	I	I	I	I	I	I	I	I	I	I	I	I
Sliding shoes / CVT rollers			R		R		R		R		R		R
Tyre pressure and wear	I	I	I	I	I	I	I	I	I	I	I	I	I
Vehicle road test	I	I	I	I	I	I	I	I	I	I	I	I	I
Idle speed	A		A		A		A		A		A		A
Odometer gear	L		L		L		L		L		L		L
Suspension			I		I		I		I		I		I
Steering	A		I		I		I		I		I		I
Transmission			L		L		L		L		L		L
Mixer oil pipes	I		I		I		I		I		I		I

I: INSPECT AND CLEAN, ADJUST, LUBRICATE OR REPLACE, IF NECESSARY

C: CLEAN, R: REPLACE, A: ADJUST, L: LUBRICATE

Clean the SAS air filter every 2 years

** Check level every 500 km*

*** Replace every 2 years*

TABLE OF RECOMMENDED PRODUCTS

Product	Description	Specifications
AGIP GEAR SAE 80W-90	Lubricant for gearboxes and transmissions.	API GL-4
eni i-Ride PG 5W-40	Synthetic based lubricant for high-performance four-stroke engines.	JASO MA, MA2 - API SL - ACEA A3
AGIP FILTER OIL	Special product for the treatment of foam filters.	-
eni i-Ride PG 2t	Synthetic based lubricant for low smoke 2-stroke engines and additives.	API TC - JASO FC - ISO-L-EGD
AGIP GP 330	Water repellent stringy calcium spray grease.	R.I.D./A.D.R. 2 10°b) 2 R.I.Na. 2.42 - I.A.T.A. 2 - I.M.D.G. class 2 UN 1950 Page 9022 EM 25-89

TABLE OF CONTENTS

B

Battery: 34

C

Checks: 18

Clock: 9

F

Fuses: 37

I

Identification: 14

K

Keys: 13

M

Maintenance: 27

P

Puncture: 45

R

Refuelling: 18

T

Toolkit: 55

Tyres: 29

V

Vehicle: 7



The descriptions and images in this publication are given for illustrative purposes only and are not binding. While the basic characteristics as described and illustrated in this booklet remain unchanged, Piaggio & C. S.p.A. reserves the right, at any time and without being required to update this publication beforehand, to make any changes to components, parts or accessories, which it considers necessary to improve the product or which are required for manufacturing or construction reasons.

Not all versions/models shown in this publication are available in all countries. The availability of each model should be checked at the official PIAGGIO sales network.

© Copyright 2012 - Piaggio & C. S.p.A. All rights reserved. Reproduction of this publication in whole or in part is prohibited.

Piaggio & C. S.p.A. Viale Rinaldo Piaggio, 25 - 56025 PONTEDERA (PI), Italy

www.piaggio.com