

Piaggio would like to thank you

for choosing one of its products. We have prepared this manual to help you to get the very best from your vehicle. Please read it carefully before riding the vehicle for the first time. It contains information, tips and precautions for using your vehicle. It also describes features, details and devices to assure you that you have made the right choice. We believe that if you follow our suggestions, you will soon get to know your new vehicle and it will serve you well for a long time to come. This booklet forms an integral part of the vehicle; should the vehicle be sold, it must be transferred to the new owner.

Fly 50 4T



PIAGGIO®

The instructions given in this booklet are intended to provide a clear, simple guide to using your scooter; this booklet also details routine maintenance procedures and regular checks that should be carried out on the vehicle at an **authorised Dealer or Service Centres**. The booklet also contains instructions for simple repairs. Any operations not specifically described in this booklet require the use of special tools and/or particular technical knowledge: to carry out these operations, refer to any **authorised Dealer or Service Centres**.



Personal safety

Failure to completely observe these instructions will result in serious risk of personal injury.



Safeguarding the environment

Sections marked with this symbol indicate the correct use of the vehicle to prevent damaging the environment.



Vehicle intactness

The incomplete or non-observance of these regulations leads to the risk of serious damage to the vehicle and sometimes even the invalidity of the guarantee.

The signs that you see on this page are very important. They are used to highlight parts of the booklet that should be read with particular care. The different symbols are used to make each topic in the manual simple and quick to locate.

INDEX

VEHICLE	7	Spark plug dismantlement.....	32
Dashboard.....	8	Removing the air filter.....	33
Clock.....	9	Secondary air system.....	34
Key switch.....	10	Checking the brake oil level.....	35
Locking the steering wheel.....	10	Battery.....	36
Releasing the steering wheel.....	10	Checking the electrolyte level.....	37
Switch direction indicators.....	11	Long periods of inactivity.....	38
Horn button.....	11	Fuses.....	39
Light switch.....	12	Front light group.....	41
Start-up button.....	12	Headlight adjustment.....	42
Opening the saddle.....	13	Front direction indicators.....	43
Keys.....	13	Rear optical unit.....	43
Identification.....	14	Rear-view mirrors.....	44
Rear top box opening.....	14	Idle adjustment.....	44
Bag clip.....	15	Front disc brake.....	45
USE	17	Rear drum brake.....	46
Checks.....	18	Puncture.....	46
Refuelling.....	18	Periods of inactivity.....	47
Tyre pressure.....	19	Cleaning the vehicle.....	47
Running in.....	20	TECHNICAL DATA	53
Starting up the engine.....	20	Toolkit.....	57
Precautions.....	21	SPARE PARTS AND ACCESSORIES	59
Difficult start up.....	22	Warnings.....	60
Stopping the engine.....	23	SCHEDULED MAINTENANCE	61
Automatic transmission.....	23	Scheduled servicing table.....	62
Safe driving.....	24		
MAINTENANCE	27		
Engine oil level.....	28		
Engine oil level check.....	28		
Engine oil top-up.....	29		
Engine oil change.....	29		
Hub oil level.....	30		
Tyres.....	31		

Fly 50 4T



PIAGGIO®



**Chap. 01
Vehicle**

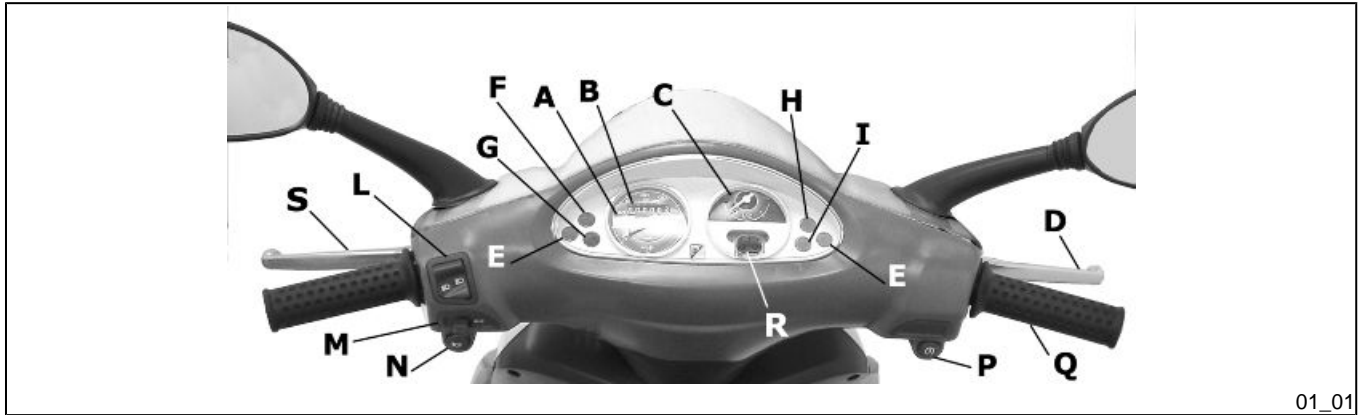

01_01

Dashboard (01_01)

A = Speedometer

B = Odometer

C = Fuel gauge

D = Front brake control lever

E = Turn indicator warning light

F = Preset light

G = High-beam warning light

H = Low fuel warning light

I = Low-beam/position light warning light

L = High/low beam switch

- M** = Turn indicator switch
- N** = Horn button
- P** = Starter button
- Q** = Throttle grip
- R** = Digital clock
- S** = Real brake control lever

Clock (01_02)

Hours and minutes are displayed in a 1 to 12, AM or PM, format on the instrument panel.

Operating the function selection switch «**T**» month, day and seconds can be seen besides hours and minutes. In order to adjust the above mentioned functions, operate button «**U**». The digital clock is powered by a battery (battery life is about 2 years); lift the whole instrument panel to replace the battery. It is advisable to take your vehicle to an **Authorised Service Centre** for this operation.

WARNING



DEAD BATTERIES ARE HARMFUL TO THE ENVIRONMENT. THEY MUST DISPOSED OF IN SUITABLE CONTAINERS AS PRESCRIBED BY THE REGULATIONS IN FORCE.

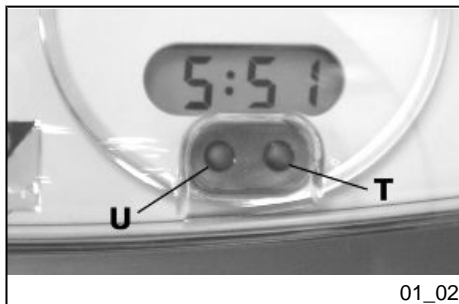



01_03

Key switch (01_03)

LOCK = Ignition disabled, extractable key, steering lock engaged front glove-box locked.

OFF = Ignition disabled, extractable key, steering lock disengaged, front glove-box unlocked.

ON = Ready to start position, anti-theft device disabled, non-extractable key, glove-box unlocked.

Locking the steering wheel

Turn the handlebar to the left (as far as it will go), turn the key to «**LOCK**» and remove the key.

CAUTION



DO NOT TURN THE KEY TO «LOCK» OR «KEY OFF» WHILE RIDING.

Releasing the steering wheel

Reinsert the key and turn it to «**OFF**».

CAUTION



DO NOT TURN THE KEY TO «LOCK» OR «KEY OFF» WHILE RIDING.

Switch direction indicators (01_04)

To set the left turn indicators flashing, move lever «B» to the left; to set the right turn indicators flashing, move it to the right. The lever automatically returns to the central position and the indicators remain on. To turn the indicators off, press the lever towards the switch.

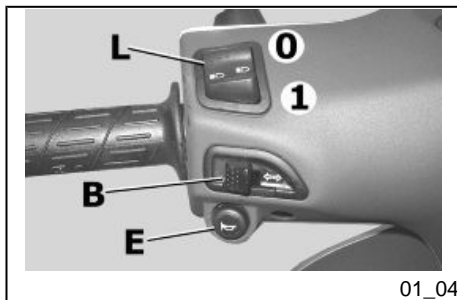

01_04

Horn button (01_05)

Horn button «E»

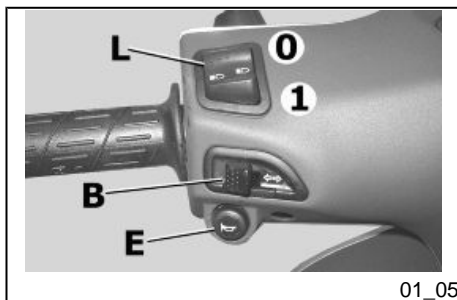

01_05

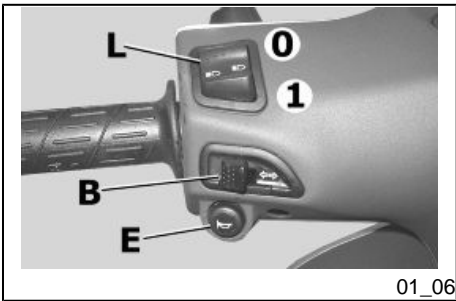

Light switch (01_06)

0 = Low-beam and tail light

1 = High-beam and tail light

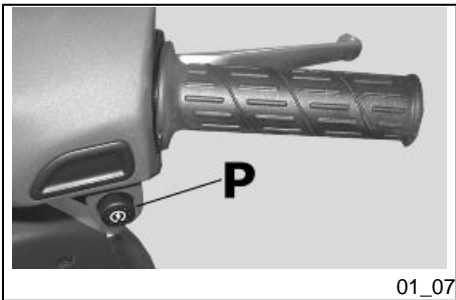

Start-up button (01_07)

To start the engine, press the starter button, «P», after pulling either one of the two brake levers.

Opening the saddle (01_08)

Insert the key into the saddle lock «A», turn it anticlockwise and tip the saddle forward.

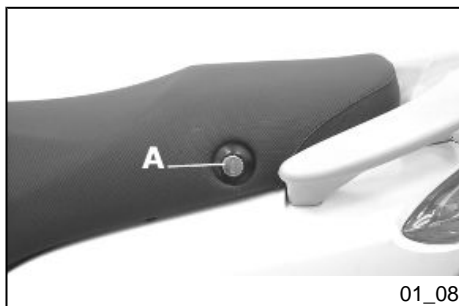

Keys (01_09)

The vehicle is supplied with two keys (one spare) which serve to start the engine and unlock the saddle compartment. The keys are accompanied by a tag marked with the identification code to be quoted when ordering duplicates.

WARNING

WE RECOMMEND KEEPING THE DUPLICATE KEY TOGETHER WITH ITS CODE IN A SAFE PLACE AND NOT ON THE VEHICLE





01_10



01_11

Identification (01_10, 01_11)

The identification numbers consist of a prefix stamped on the chassis and on the engine, followed by a number. They should always be given when requesting spare parts. We recommend that you check that the prefix and chassis number stamped on the vehicle correspond with those in the vehicle documents.

CAUTION



BE REMINDED THAT ALTERING IDENTIFICATION REGISTRATION NUMBERS CAN LEAD TO SERIOUS PENAL SANCTIONS (IMPOUNDING OF THE VEHICLE, ETC.).

Rear top box opening

Turn the key to «OFF». Then press it. When the key is set to «LOCK», the glove-box is locked.

Bag clip (01_12)

To use the retractable bag hook «**B**» located at the front end of the saddle, pull it forward lightly.

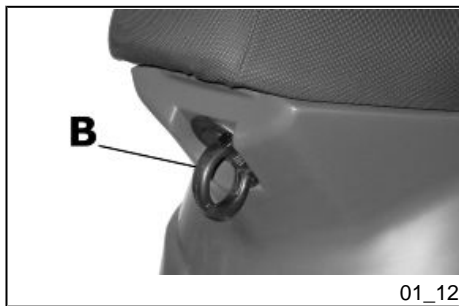

Fly 50 4T



PIAGGIO®



Chap. 02
Use

Checks

Before using the vehicle, check:

1. that the fuel tank is full.
2. The oil level in the rear hub.
3. engine oil level (see section «Engine oil level»).
4. That tyres are properly inflated.
5. correct functioning of headlights, rear taillight and turn indicators.
6. The correct functioning of the front and rear brakes.

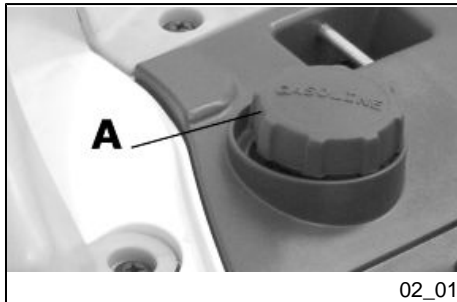

Refuelling (02_01)

Refill the fuel tank «A» with unleaded petrol (min octane = 95).

A low fuel level warning light on the dashboard indicates that reserve fuel is being used.

CAUTION



SHUT OFF THE ENGINE BEFORE REFUELLING WITH PETROL. PETROL IS HIGHLY FLAMMABLE. DO NOT LET PETROL SPILL FROM THE TANK OR WHILE REFUELLING

CAUTION



DO NOT BRING NAKED FLAMES OR CIGARETTES NEAR THE MOUTH OF THE FUEL TANK: FIRE HAZARD. ALSO AVOID INHALING HARMFUL VAPOURS.

CAUTION

USING OILS OTHER THAN THOSE RECOMMENDED CAN SHORTEN THE LIFE OF THE ENGINE.

Characteristic**Fuel tank capacity**

approx. 7.2 litres (of which 1.5 l is reserve)

Tyre pressure**CAUTION**

TYRE PRESSURE SHOULD BE CHECKED WHEN TYRES ARE COLD. INCORRECT TYRE PRESSURE CAUSES ABNORMAL TYRE WEAR AND MAKES RIDING DANGEROUS.

TYRES MUST BE REPLACED WHEN THE TREAD REACHES THE WEAR LIMITS SET FORTH BY LAW.

Characteristic**Front tyre pressure**

1.8 bar

Rear tyre pressure

2 bar

Rear wheel pressure (rider and passenger):

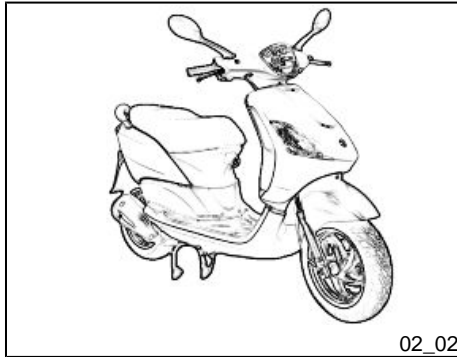

Running in (02_02)

WARNING



DURING THE FIRST 1000 KM DO NOT RIDE THE VEHICLE OVER 80% OF ITS MAXIMUM SPEED. AVOID TWISTING THE THROTTLE GRIP FULLY OR KEEPING A CONSTANT SPEED ALONG LONG SECTIONS OF ROAD. AFTER THE FIRST 1000 KM, GRADUALLY INCREASE SPEED UNTIL REACHING THE MAXIMUM PERFORMANCE.

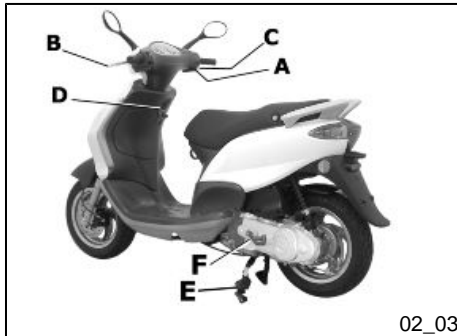

Starting up the engine (02_03)

The vehicle is fitted with direct drive automatic transmission. Therefore, always start the engine with the throttle grip slightly twisted; to start-off from still, progressively twist the throttle grip.

The vehicle is equipped with a fuel valve and a starter which switch on automatically as soon as the engine is started.

To start it up, it is necessary to:

1: Put the scooter on its stand "E"; check that the rear wheel is off the ground.

2: Keep the throttle grip slightly twisted.

3: Insert the key in ignition switch «D» and turn it to «ON»; when turning the key to «ON», the fuel reserve warning light turns on for a few seconds indicating the correct functioning of the bulb.

4: Push the starter button «A» after pulling the rear brake lever «B» or the front brake lever «C».

CAUTION

DO NOT CARRY OUT THESE OPERATIONS IN CLOSED AREAS SINCE EXHAUST GASES ARE TOXIC.

CAUTION

ALWAYS PLACE THE VEHICLE ON ITS STAND BEFORE KICK STARTING.

Precautions**CAUTION**

NEVER STRESS THE ENGINE AT LOW TEMPERATURES IN ORDER TO AVOID POSSIBLE DAMAGE. BE CAREFUL NEVER TO EXCEED THE MAXIMUM SPEED WHILE RUNNING DOWNHILL, IN ORDER TO AVOID DAMAGING THE ENGINE. IN ANY CASE, IN ORDER TO PRESERVE THE ENGINE FROM PROLONGED OVERREVVING, THE REVOLUTION LIMITER WILL BE ACTIVATED IF THE ENGINE SPEED EXCEEDS THE ESTABLISHED THRESHOLD.

WARNING

AFTER A LONG DISTANCE COVERED AT THE MAXIMUM SPEED, DO NOT STOP THE ENGINE IMMEDIATELY, BUT LET IT RUN AT IDLE FOR A FEW SECONDS.

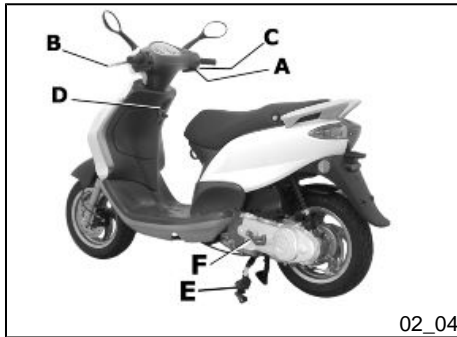
**Difficult start up (02_04)**

If there is a problem you can follow the instructions below:

- 1. Engine flooded.** Place the vehicle on its centre stand and check that the rear wheel is off the ground. Open the throttle fully and press the starter button for five seconds and then stop for five seconds. If the engine does not start after a few attempts, let the engine sit for a few minutes and then repeat the above operations. In any case do not operate the starter motor longer than 20" in an attempt to start the engine.
- 2. Battery or starter motor inefficiency.** Put the scooter on its stand "E"; make sure that the rear wheel is off the ground, turn the key switch «D» to «ON» and use the kick-starter «F».
- 3. Empty fuel tank.** After refuelling the scooter, start the engine by pressing the starter button «A» with the throttle at a minimum to provide maximum aspiration for the tap. If the vehicle fails to start even after carrying out the steps described above, contact an **Authorised Service Centre**.

CAUTION

ALWAYS PLACE THE VEHICLE ON ITS STAND BEFORE KICK STARTING.

WARNING

TAMPERING MAY CAUSE SERIOUS ENGINE MALFUNCTION.

Stopping the engine (02_05)

Stop acceleration, then turn the key switch «D» to «OFF» to stop the engine (extractable key).

CAUTION

DUE TO THE HIGH TEMPERATURES THE CATALYTIC CONVERTER CAN REACH, ALWAYS TAKE CARE, WHEN PARKING THE VEHICLE, THAT THE SILENCER DOES NOT COME INTO CONTACT WITH FLAMMABLE MATERIALS, TO AVOID SERIOUS BURNS.

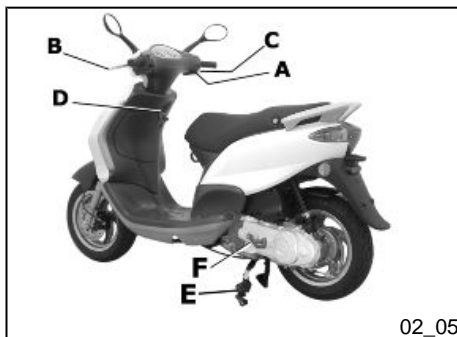

02_05

Automatic transmission

To ensure simple, pleasurable riding, the vehicle is equipped with automatic transmission with regulator and centrifugal clutch. The system is designed to give the best possible performance in terms of both acceleration and consumption, on level ground and uphill, thanks to the adjustments made to engine speed and transmitted torque. If you have to stop on an uphill slope (traffic lights, traffic jam, etc.) only use the brake to keep the vehicle still, leaving the motor running at idling speed. Using the motor to keep the vehicle still can cause the clutch to overheat. This problem is due to the friction of the clutch parts on the clutch bell. It is therefore recommended to avoid conditions of prolonged clutch slippage leading to clutch overheating (for example, as

well as the situation described above, riding uphill fully laden on steep slopes or starting off on slopes greater than 25%, etc.):

1. Do not continue riding in such conditions.
2. Let the clutch cool down with the motor at idling speed for a few minutes

Safe driving

WARNING



SOME SIMPLE TIPS ARE PROVIDED BELOW WHICH WILL ENABLE YOU TO USE YOUR VEHICLE ON A DAILY BASIS MORE EASILY AND SAFELY.

<

Your ability and your knowledge of the vehicle form the basis of safe riding. We recommend trying out the vehicle in traffic-free zones to get to know your vehicle completely.

ALWAYS DRIVE WITHIN YOUR LIMITS

1. Before riding off, remember to put the helmet on and fasten it correctly.
- 2.Reduce speed on rough roads and ride with caution.
- 3.Remember that after riding on a long stretch of wet road without using the brakes, braking can be poor at the beginning. Under these conditions, it is a good idea to operate the brakes from time to time.
- 4.Do not brake hard on wet, unsurfaced or slippery roads.
- 5.If you have to brake, use both brakes in order to spread the braking action between both wheels.

6. Avoid riding off by mounting the scooter when it is resting on its support. In any case, the rear wheel should not be turning when it comes into contact with the ground, in order to avoid abrupt departures.

7. If the vehicle is used on roads covered with sand, mud, snow mixed with salt, etc., clean brake discs frequently with a mild detergent in order to avoid the formation of abrasive substances in the holes, which could result in early wear of the brake pads.

8. Remember that any change that modifies the vehicle's performance, such as tampering with original structural parts, renders the vehicle not conforming to the approved type and therefore dangerous to ride.

CAUTION



RIDING UNDER THE INFLUENCE OF ALCOHOL, DRUGS OR CERTAIN MEDICINES CAN BE EXTREMELY DANGEROUS FOR ONESELF AND FOR OTHERS.

CAUTION



ANY ELABORATION THAT MODIFIES THE VEHICLE'S PERFORMANCES, SUCH AS TAMPERING WITH ORIGINAL STRUCTURAL PARTS IS STRICTLY FORBIDDEN BY LAW, AND RENDERS THE VEHICLE NO LONGER CONFORMING TO THE APPROVED TYPE AND DANGEROUS FOR RIDING.

Fly 50 4T



PIAGGIO®



**Chap. 03
Maintenance**

Engine oil level

In 4T engines, the engine oil is used to lubricate the distribution elements, the bench bearings and the thermal group. **An insufficient quantity of oil can cause serious damage to the engine itself.** In all 4T engines the decay of oil characteristics as well as some consumption is normal. Consumption can particularly reflect the conditions of use (i.e. when driving at "full acceleration" all the time, oil consumption increases). **In order to avoid problems, it is advisable to control oil level every time the vehicle is used.**

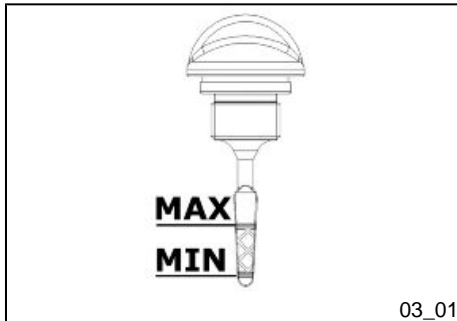

Engine oil level check (03_01)

Check oil level every time the vehicle is used, with the engine cold. The level should be between the MAX and MIN marks on the oil level dipstick shown in figure; the stand should be firm on an even surface during the check.

If the check is carried out after the vehicle has been used, i.e. the engine is hot, the level line will be very low; for an adequate check, wait at least 10 minutes after the engine stops in order to have the correct level.

Check by pushing the dipstick all the way into the hole.

CAUTION



RUNNING THE ENGINE WITH INSUFFICIENT LUBRICATION OR WITH THE WRONG LUBRICANTS MAY INCREASE WEAR AND TEAR ON THE MOVING PARTS AND MAY CAUSE SERIOUS DAMAGE.

Characteristic

Engine oil

Capacity: ~ 850 cc

Engine oil top-up

Always check oil level before carrying out top-ups and add oil **without exceeding the MAX level**. An engine oil check-up and top-up should be carried out every 3,000 km at an **Authorised Piaggio Service Centre**.

Engine oil change (03_02)

Change oil and clean the filter after every 6,000 km at an **Authorised Service Centre**. Empty the engine by draining the oil through drainage cap «C» with a cold engine. First unscrew the cap-dipstick used to check engine oil level, then cap «C» and take out the mesh filter. After cleaning and mounting again the mesh filter, screw cap «C» and fill with oil the hole of the cap-dipstick used to check engine oil level. Then start the vehicle, leave it running for a few minutes and switch it off: 5 minutes later check oil level and, if necessary, add oil **without exceeding the MAX level**. Only use new oil of the recommend type for oil top-ups and change.

CAUTION



USED OILS CONTAIN SUBSTANCES HARMFUL TO THE ENVIRONMENT. FOR OIL CHANGE, CONTACT AN AUTHORISED SERVICE CENTRE WHICH IS EQUIPPED TO DISPOSE OF USED OILS IN AN ENVIRONMENTALLY FRIENDLY AND LEGAL WAY.

Recommended products

AGIP CITY HI TEC 4T

Engine oil

SAE 5W-40, API SL, ACEA A3, JASO MA Synthetic oil

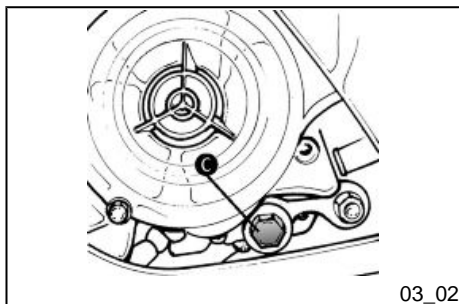

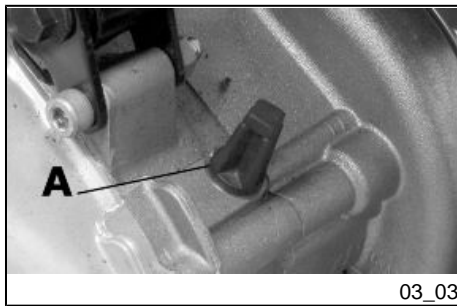

Hub oil level (03_03, 03_04, 03_05)

To check the hub oil level, proceed as follows:

1. Place the vehicle on its stand on a level surface;
2. Unscrew the oil dipstick «A», dry it with a clean rag and then reinsert it, **screwing it tightly into place**;
3. Unscrew the dipstick again and check that the oil level barely reaches the **2nd notch from the bottom**;
4. Screw the dipstick back into place completely.

The screw «B» is the hub oil drainage plug.

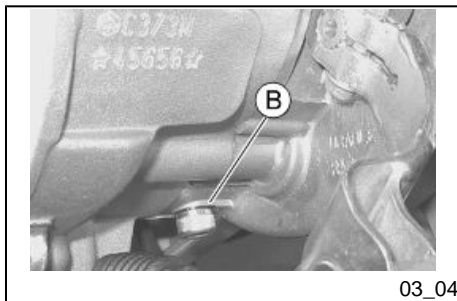

CAUTION



RUNNING THE ENGINE WITH INSUFFICIENT LUBRICATION OR WITH THE WRONG LUBRICANTS MAY INCREASE WEAR AND TEAR ON THE MOVING PARTS AND MAY CAUSE SERIOUS DAMAGE.

CAUTION



USED OILS CONTAIN SUBSTANCES HARMFUL TO THE ENVIRONMENT. FOR OIL CHANGE, CONTACT AN AUTHORISED SERVICE CENTRE WHICH IS EQUIPPED TO DISPOSE OF USED OILS IN AN ENVIRONMENTALLY FRIENDLY AND LEGAL WAY.

N.B.

THE NOTCHES ON THE HUB OIL LEVEL DIPSTICK, EXCEPT THOSE INDICATING THE MAXIMUM AND MINIMUM LEVELS, REFER TO OTHER MODELS BY THE MANUFACTURER, AND HAVE NO SPECIFIC FUNCTION FOR THIS MODEL.

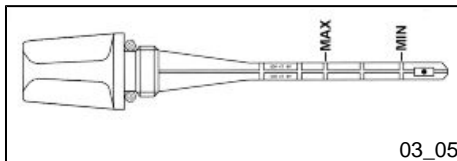

Recommended products

AGIP ROTRA 80W-90

Rear hub oil

SAE 80W/90 Oil that exceeds the requirements of API GL3 specifications

Characteristic

Rear hub oil

Quantity: approx. 85 cc

Tyres (03_06)

Periodically check the inflation pressure of each tyre (when cold). The tyres are fitted with a wear indicator and must be replaced as soon as such indicator appears on the tread. Also ensure that the tyres do not show cuts on the walls or an irregular wear of the tread; if this is the case, please contact an authorised or adequately equipped workshop.

CAUTION



TYRE PRESSURE SHOULD BE CHECKED WHEN TYRES ARE COLD. INCORRECT TYRE PRESSURE CAUSES ABNORMAL TYRE WEAR AND MAKES RIDING DANGEROUS.

TYRES MUST BE REPLACED WHEN THE TREAD REACHES THE WEAR LIMITS SET FORTH BY LAW.

Characteristic

Front tyre pressure

1.8 bar

Rear tyre pressure

2 bar

Rear wheel pressure (rider and passenger):

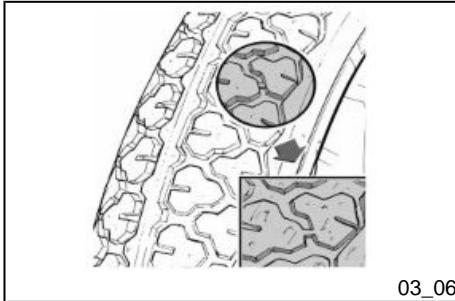

03_06

2.3 bar

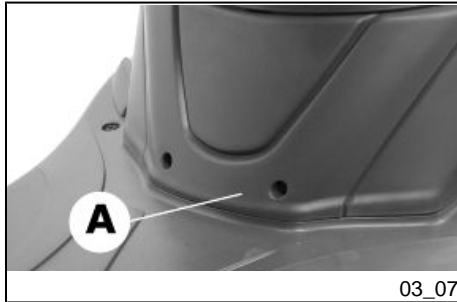

03_07

Spark plug dismantlement (03_07, 03_08)

Remove cover «A» after unscrewing the corresponding screws. Detach the spark plug shielded cap and remove the plug with the box-spanner supplied. When refitting the plug, tighten it manually, being sure to insert it at the right angle; Use the wrench only to fasten it. Carefully reinsert the screening hood. To reassemble the cover follow the steps in reverse order, making sure to insert the pin in the upper part of the central cover.

CAUTION



FOLLOW THESE PROCEDURES VERY CAREFULLY TO AVOID ANY SEVERE DAMAGE THAT MAY BE CAUSED BY THE VERY POWERFUL IGNITION SYSTEM.

CAUTION



THE SPARK PLUG MUST BE REMOVED WHEN THE ENGINE IS COLD. USING IGNITION ELECTRONIC CENTRAL UNITS OR SPARK PLUGS OTHER THAN THE TYPES PRESCRIBED (SEE «TECHNICAL DATA» SECTION) CAN CAUSE SERIOUS DAMAGE TO THE ENGINE.

Characteristic

Spark plug

NGK CR 8EB

Alternative spark plug

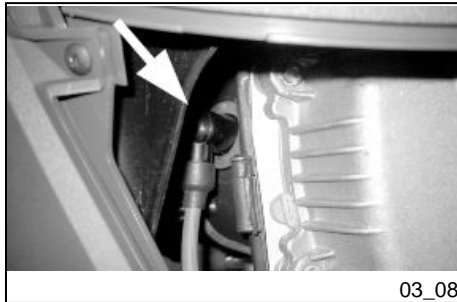

03_08

DENSO U24ESR-NB

Removing the air filter (03_09, 03_10)

After removing the spark plug cover, remove the side fairing unscrewing the 3 screws **A**. Remove the air cleaner cap «**D**»; take out the filter after unscrewing the 6 fixing screws «**C**». Clean with water and shampoo, afterwards dry with compressed air and submerge in a recommended oil and petrol mixture in ratio of 50%. Afterwards squeeze it, leave it to dry and mount it again.

CAUTION



IN CASE OF RIDING ON DUSTY ROADS IT IS ADVISABLE TO CLEAN THE AIR FILTER MORE FREQUENTLY THAN INDICATED IN THE RELEVANT CHAPTER ON SCHEDULED MAINTENANCE.

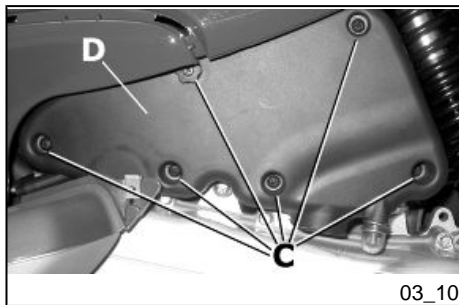
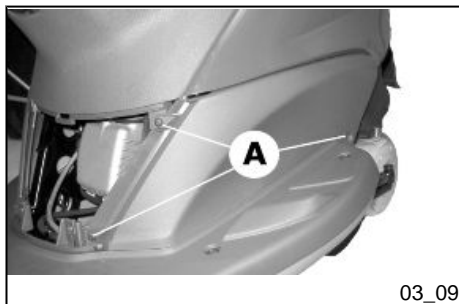

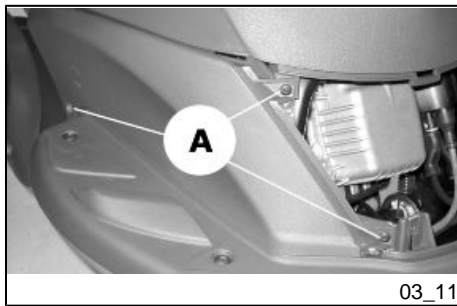

Secondary air system (03_11, 03_12, 03_13, 03_14)

After taking out the plug spark cover, unscrew the three screws «A» and remove the right fairing. Unscrew the three screws «B» and remove the housing cover of the secondary air system. Detach the housing cover and remove the filtering element «C» made of sponge. Wash the sponge with water and neutral soap, then dry with a clean cloth and short blasts of compressed air. While cleaning the filter, check the condition of the reed valve «D», and mount it back in place on the housing.

Before closing the cover of the SAS housing, check the good condition of the sealing O-ring; replace it if damaged or deformed.

N.B.

The reed valve can be inserted in only one direction on the SAS housing

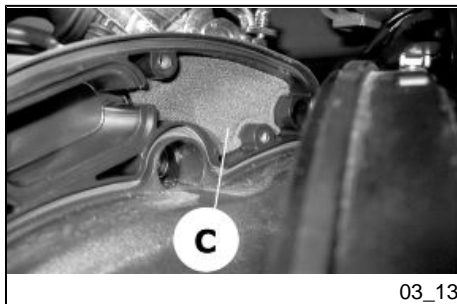
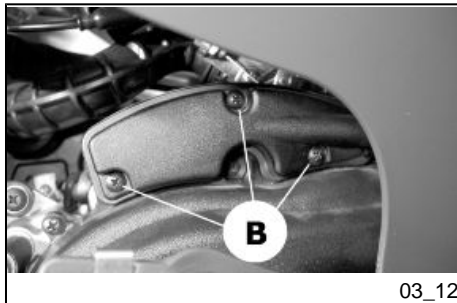

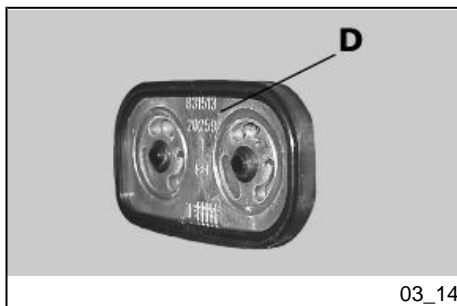

03_14

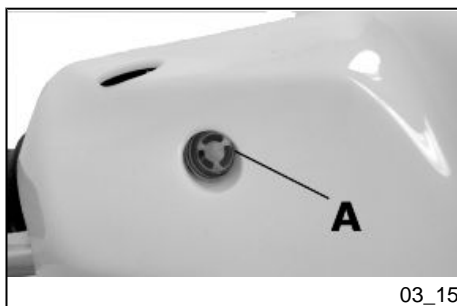

03_15

Checking the brake oil level (03_15, 03_16)

The brake fluid reservoir is equipped with a sight glass «A» made of transparent material; the quantity of liquid contained in the sight glass indicates the level of liquid in the reservoir.

When the sight glass «A» is full, the level inside the reservoir exceeds the MIN level; when it is partially full, the level drops to the MIN level; when it is fully empty, the level of fluid in the reservoir is below the MIN level.

The brake fluid level may fall due to wear on the brake pads. In case the pad wear is below the minimum mark, contact an **Authorised Service Centre** to have the braking system thoroughly checked. If you need to top up the level, follow the steps listed below. Unscrew the 2 screws «B», remove the reservoir cap «C» and pour in the required quantity of fluid (the brake fluid level must be above minimum). Place the handlebar in the riding position and pay attention not to tilt the vehicle in order to keep the brake fluid reservoir in horizontal position when checking the fluid level.

CAUTION



TOP-UPS SHOULD ONLY BE CARRIED OUT WITH DOT4 CLASSIFIED BRAKE FLUID.

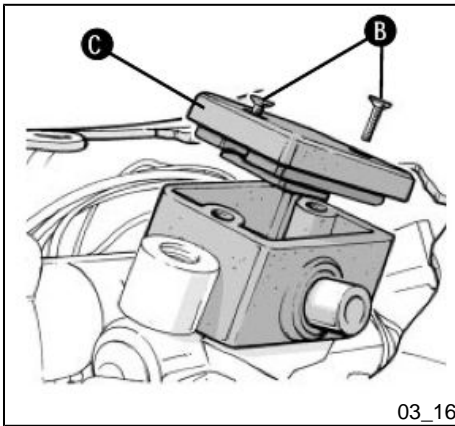

03_16

WARNING

IN NORMAL CLIMATIC CONDITIONS IT IS ADVISABLE TO REPLACE THE ABOVE-MENTIONED FLUID EVERY 2 YEAR. NEVER USE BRAKE FLUID CONTAINED IN CONTAINERS WHICH ARE ALREADY OPEN OR PARTIALLY USED.

CAUTION

THE BRAKING CIRCUIT FLUID IS HIGHLY CORROSIVE. THEREFORE, WHEN TOPPING IT UP, AVOID LETTING IT COME INTO CONTACT WITH THE PAINTED PARTS OF THE VEHICLE. THE BRAKING CIRCUIT FLUID IS HYGROSCOPIC, THAT IS, IT ABSORBS HUMIDITY FROM THE SURROUNDING AIR. IF MOISTURE CONTAINED IN THE BRAKE FLUID EXCEEDS A CERTAIN VALUE, THIS WILL RESULT IN INEFFICIENT BRAKING.



03_17

Battery (03_17)

Lift the saddle forward to access the battery then remove access door to the battery by unscrewing the star-shaped screws as shown in the picture.

The battery is the electrical device that requires the most frequent attention and the most thorough maintenance.

WARNING

USED BATTERIES ARE HARMFUL FOR THE ENVIRONMENT. COLLECTION AND DISPOSAL SHOULD BE CARRIED OUT IN COMPLIANCE WITH REGULATIONS IN FORCE.

CAUTION

ELECTROLYTE CONTAINS SULPHURIC ACID: AVOID CONTACT WITH EYES, SKIN AND CLOTHES. IN CASE OF ACCIDENTAL CONTACT, RINSE WITH ABUNDANT WATER AND CONSULT A DOCTOR.

CAUTION

IN ORDER TO AVOID DAMAGING THE ELECTRIC SYSTEM, NEVER DISCONNECT THE WIRING WHILE THE ENGINE IS RUNNING. DO NOT TIP THE VEHICLE TOO MUCH IN ORDER TO AVOID DANGEROUS LEAKAGE OF THE BATTERY ELECTROLYTE

Checking the electrolyte level

The electrolyte level, which should be checked regularly, must always be at the maximum level. To reach this level, use only distilled water. Should it become necessary to top up the battery with water too frequently, check the scooter's electrical system because the battery is being overloaded, causing it to lose power quickly.

CAUTION

ELECTROLYTE CONTAINS SULPHURIC ACID: AVOID CONTACT WITH EYES, SKIN AND CLOTHES. IN CASE OF ACCIDENTAL CONTACT, RINSE WITH ABUNDANT WATER AND CONSULT A DOCTOR.

Long periods of inactivity

Battery performance will decrease if the vehicle is not used for a long time. This is the result of the natural phenomenon of battery discharging, and may be due to residual absorption by vehicle components with constant power consumption. Poor battery performance may also be due to environmental conditions and the cleanliness of the poles. In order to avoid difficult starts and/or irreversible damage to the battery, follow any of these steps:

- **At least once a month** start the engine and run it slightly above idle speed for 10-15 minutes. This keeps all the engine components, as well as the battery, in good working order.

- Take your vehicle to a garage (as indicated in the «Vehicle not used for extended periods» section) to have the battery removed. Have the battery cleaned, charged fully and stored in a dry, ventilated place. Recharge **at least once every two months**.

N.B.

THE BATTERY MUST BE CHARGED WITH A CURRENT EQUAL TO 1/10 OF THE RATED CAPACITY OF THE BATTERY AND FOR NOT LONGER THAN 10 HOURS. CONTACT AN AUTHORISED SERVICE CENTRE TO CARRY OUT THIS OPERATION SAFELY. WHEN REFITTING THE BATTERY MAKE SURE THE LEADS ARE CORRECTLY CONNECTED TO THE TERMINALS.

WARNING



DO NOT DISCONNECT THE BATTERY CABLES WITH THE ENGINE RUNNING, THIS CAN CAUSE IRREPARABLE DAMAGE TO THE VEHICLE'S ELECTRONIC CONTROL UNIT.

WARNING

USED BATTERIES ARE HARMFUL FOR THE ENVIRONMENT. COLLECTION AND DISPOSAL SHOULD BE CARRIED OUT IN COMPLIANCE WITH REGULATIONS IN FORCE.

Fuses (03_18)

The electrical system is protected by a 10A fuse valve «B» located next to the battery. Before replacing a blown fuse, find and solve the problem that caused it to blow. Do not substitute the fuse with any alternative form of conductor

CAUTION

IN ORDER TO AVOID DAMAGING THE ELECTRIC SYSTEM, NEVER DISCONNECT THE WIRING WHILE THE ENGINE IS RUNNING. DO NOT TIP THE VEHICLE TOO MUCH IN ORDER TO AVOID DANGEROUS LEAKAGE OF THE BATTERY ELECTROLYTE

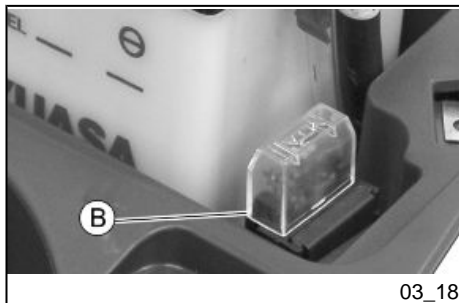
**BULBS**

High/low beam light bulb

Type: Spherical

Power: 12V 35/35W

	Quantity: 1
Front side light bulb	Type: All glass Power: 12V 5W Quantity: 1
Instrument panel bulb	Type: All glass Power: 12V - 2W Quantity: 1
Instrument panel light bulbs	Type: All glass Power: 12V 1.2W Quantity: 2
Front turn indicator light bulb	Type: Spherical Power: 12V - 10W Quantity: 1 RHS + 1 LHS
Rear turn indicator light bulb	Type: Spherical Power: 12V - 10W Quantity: 1 RHS + 1 LHS
Stop and tail light bulb	Type: Spherical Power: 12V 21/5W Quantity: 1
12V - 2W warning light bulbs	Type: All glass Function: Turn indicators

Quantity: 2

12V - 1.2W warning light bulb

Type: All glass**Function:** Lights, high-beam lights, fuel reserve**Quantity:** 3

Front light group (03_19, 03_20)

To access the headlight bulbs, remove the front of the handlebar cover, as follows:

- 1) Remove the rear-view mirrors; for this operation follow the instructions described and illustrated in the «Rear-view mirrors» section.
- 2) Unscrew the 3 screws holding the handlebar cover. The front central one «B» and the rear 2 «C». Once this is done, the handlebar cover can be removed.
- 3) Remove the handlebar cover to access the headlight and the bulbs.

N.B.

IF MISTING IS NOTICED ON THE INSIDE OF THE HEADLAMP GLASS, THIS DOES NOT INDICATE A FAULT AND IS ATTRIBUTABLE TO HUMIDITY AND/OR TO LOW TEMPERATURES.

THE PHENOMENON SHOULD QUICKLY DISAPPEAR WHEN THE LIGHT IS SWITCHED ON.

THE PRESENCE OF DROPS OF WATER, ON THE OTHER HAND, COULD INDICATE THAT WATER IS INFILTRATING. CONTACT THE AFTER-SALES SERVICE NETWORK.

Electric characteristic

Bulbs

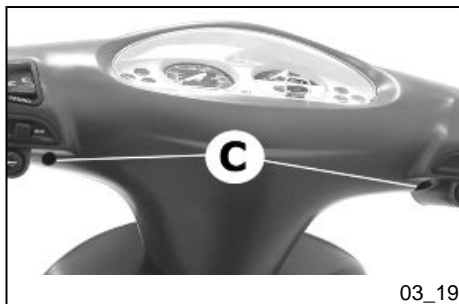

03_19

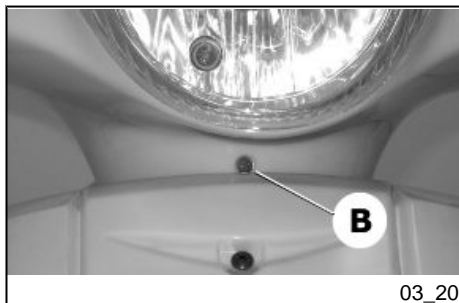

03_20

1 12V35/35W bulb for high- and low-beam light

1 12V-5W bulb for side light

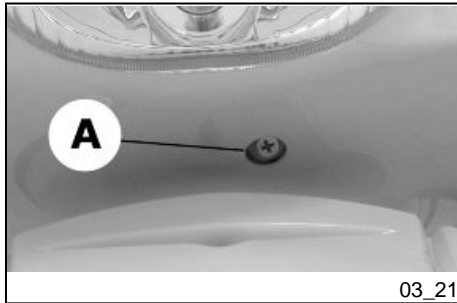

03_21

Headlight adjustment (03_21, 03_22)

Proceed as follows:

1. Place the vehicle in running order and with the tyres inflated to the prescribed pressure, on a flat surface 10 m away from a white screen situated in a shaded area, making sure that the longitudinal axis of the vehicle is perpendicular to the screen;
2. Turn on the headlight and check that the borderline of the projected light beam on the screen is no higher than 9/10 or lower than 7/10 of the distance from the ground to the centre of the vehicle's headlamp;
3. If otherwise, adjust the right headlight with screw «A».

N.B.

THE ABOVE PROCEDURE COMPLIES WITH THE EUROPEAN STANDARDS REGARDING MAXIMUM AND MINIMUM HEIGHT OF LIGHT BEAMS. REFER TO THE STATUTORY REGULATIONS IN FORCE IN EVERY COUNTRY WHERE THE VEHICLE IS USED.

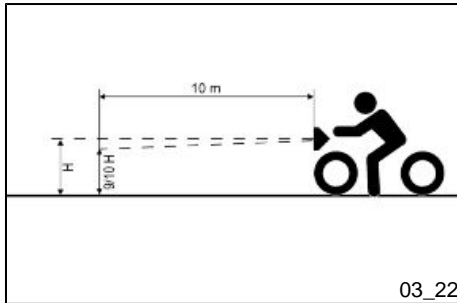

03_22



03_23

Front direction indicators (03_23)

In order to replace the front turn indicator bulbs remove the light taking off the retaining screws, then remove the bulb holder from its support; gently turn the bulb around 30° and remove it. Follow the process in reverse order to refit.

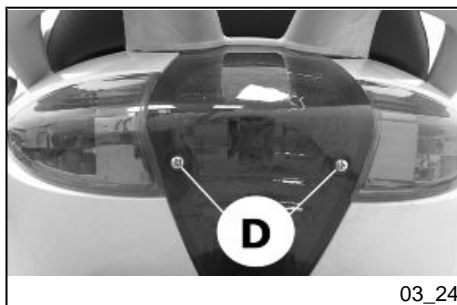

03_24

Rear optical unit (03_24)

To access the rear taillight bulb it is necessary to remove the 2 fixing screws «D». Doing so it is possible to access also the turn indicator bulbs. Gently push and turn the bulb about 30° and then remove it. To refit follow the same steps but in reverse order.

N.B.

IF MISTING IS NOTICED ON THE INSIDE OF THE HEADLAMP GLASS, THIS DOES NOT INDICATE A FAULT AND IS ATTRIBUTABLE TO HUMIDITY AND/OR TO LOW TEMPERATURES.

THE PHENOMENON SHOULD QUICKLY DISAPPEAR WHEN THE LIGHT IS SWITCHED ON.

THE PRESENCE OF DROPS OF WATER, ON THE OTHER HAND, COULD INDICATE THAT WATER IS INFILTRATING. CONTACT THE AFTER-SALES SERVICE NETWORK.

Rear-view mirrors (03_25)

The mirrors can be set to the desired position by adjusting the mirror frame.



To remove the rear-view mirror rotate the rear-view mirror support rod clockwise.

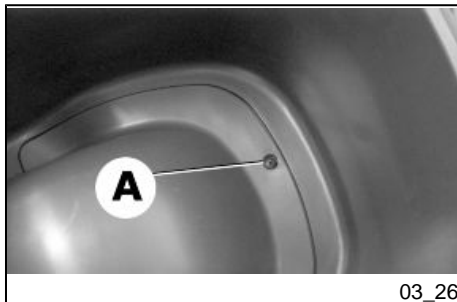

Idle adjustment (03_26, 03_27)

Proceed as follows:

1. Rest the vehicle on its centre-stand and lift the seat (as described in the "Lifting the seat & helmet compartment" section).
2. Loosen the fixing screws «A» and remove the carburettor access door.
3. Start the engine, hence tighten or loosen the idle adjusting screw «B» until the prescribed idle speed is reached and the rear wheel is not spinning.

If any problems arise during this operation, please contact your **PIAGGIO Dealer or Authorised Service Station** to perform a **CO** check at idle.

WARNING



IDLE SPEED MUST BE ADJUSTED WHEN THE ENGINE IS VERY HOT. BEFORE THIS OPERATION, MAKE SURE THAT THE THROTTLE GRIP HAS THE RECOM-

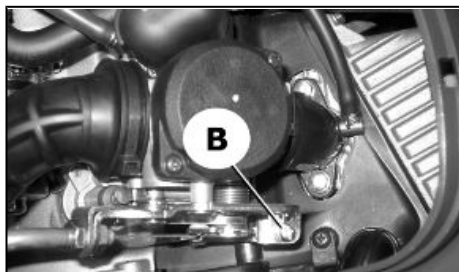

03_27

MENED CLEARANCE. IF CLEARANCE IN THE THROTTLE CONTROL TRANSMISSION NEEDS ADJUSTING TAKE YOUR SCOOTER TO AN AUTHORISED DEALER OR SERVICE CENTRE.

Characteristic

Engine idle speed

approx. 1.600 ÷ 1.800 rpm

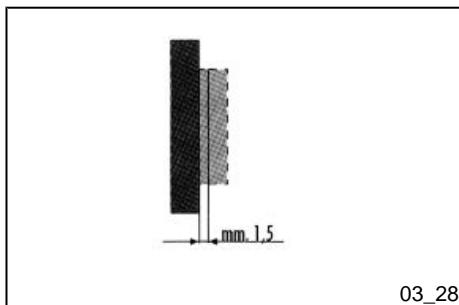

03_28

Front disc brake (03_28)

The brake disc and pad wear is automatically compensated, therefore it has no effect on the functioning of the front and rear brakes. For this reason it is not necessary to adjust the brakes. An excessively elastic brake lever stroke may indicate the presence of air in the braking circuit or an irregular brake operation. In this case, particularly considering the importance of the brakes in terms of safety, it is strongly recommended that you take the vehicle to an **Authorised Service Centre** as soon as possible for the appropriate checks.

WARNING



CHECK BRAKE PADS FOR WEAR ON A REGULAR BASIS (AS INDICATED IN THE SCHEDULE MAINTENANCE TABLES). IF THE THICKNESS OF ONE OR BOTH PADS IS IN THE REGION OF 1.5 MM, BOTH PADS MUST BE CHANGED. IT IS RECOMMENDED TO CARRY OUT THIS OPERATION AT AN AUTHORISED SERVICE CENTRE AS SOON AS POSSIBLE.

AFTER FITTING NEW BRAKE PADS DO NOT USE THE VEHICLE UNTIL YOU HAVE ACTIVATED THE BRAKE LEVER REPEATEDLY TO POSITION THE PADS AND RESTORE THE LEVER STROKE TO ITS CORRECT POSITION.

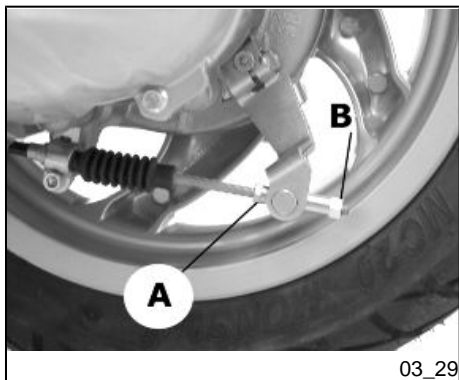

03_29

CAUTION

BRAKING SHOULD BEGIN AFTER ABOUT 1/3 OF THE BRAKE LEVER STROKE.

Rear drum brake (03_29)

Operate adjusting nut «**B**» and loosen lock nut «**A**» shown in the figure. Note that when the throttle is in idle **the wheel should rotate free**. After the adjustment, screw lock nut «**A**».

CAUTION

BRAKING SHOULD BEGIN AFTER ABOUT 1/3 OF THE BRAKE LEVER STROKE.

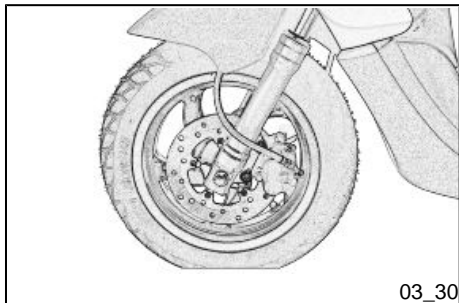

03_30

Puncture (03_30)

The vehicle is equipped with Tubeless tyres. When there is a puncture, Tubeless tyres - unlike tyres with inner tubes - go flat very slowly. This offers greater riding safety. A tyre that goes flat very slowly can be repaired with an "Inflate and Repair" spray. Tyres should be later fully repaired or replaced at an **Authorised Service Centre**.



Periods of inactivity (03_31)

We recommend carrying out the following operations:

1. General cleaning of the vehicle.
- 2 - With the engine off and the piston at bottom dead centre position, remove the spark plug and pour 1÷2 cc of motor oil through its hole. Operate the starter 3-4 times letting the engine perform a few revolutions, then remount the spark plug.
- 3 - Drain up all the vehicle's fuel; spread antirust grease on the unpainted metal parts; keep the wheels lifted above the ground.
- 4 - For the battery, follow the procedures described in the «Battery» section.
- 5 - Drain the petrol from the carburettor tank.
- 6 - Replace engine oil.

Recommended products

AGIP CITY HI TEC 4T

Oil to lubricate flexible transmissions (brakes, throttle control and odometer)
Oil for 4-stroke engines

Cleaning the vehicle

Use a low pressure jet of water to soften the caked dirt and mud deposited on the painted surfaces. Once softened, sponge off mud and dirt using a car body sponge soaked in a car body shampoo and water solution (2-4% of car shampoo in water). Then rinse with abundant water, and dry with a shammy cloth. For the engine exterior, use petrol, a brush and clean cloths. Petrol can damage paintwork. Remember that any polishing with silicone wax must always be preceded by washing.

CAUTION

DETERGENTS POLLUTE WATER. THEREFORE THE VEHICLE SHOULD BE WASHED IN AN AREA EQUIPPED FOR THE COLLECTION AND PURIFICATION OF THE LIQUIDS USED.

WARNING

NEVER WASH THE VEHICLE IN THE SUN, ESPECIALLY DURING THE SUMMER WHEN THE BODYWORK IS STILL HOT, AS THE SHAMPOO MAY DRY BEFORE BEING RINSED OFF, AND COULD DAMAGE THE PAINTWORK. NEVER USE RAGS SOAKED IN PETROL OR DIESEL OIL TO CLEAN THE PAINTED OR PLASTIC SURFACES, TO PREVENT THEM LOSING THEIR SHINE AND MECHANICAL CHARACTERISTICS.

WARNING

WHEN WASHING THE ENGINE WITH A HIGH-PRESSURE WATER JET:

- **ONLY USE FAN SPRAY JETS.**
- **KEEP NOZZLE AT LEAST 60 CM AWAY FROM THE VEHICLE**
- **DO NOT USE WATER AT TEMPERATURES ABOVE 40°C.**
- **DO NOT DIRECT THE JET AT THE CARBURETTOR, THE ELECTRIC CABLES, THE COOLING SLITS IN THE TRANSMISSION COVER AND THE SPIRAL COVER.**

START-UP PROBLEMS

No fuel in tank	Refuel
Filters, jets or carburettor body dirty or clogged.	Contact an Authorised Service Centre.
Insufficient battery charge	Kick-start. Recharge the battery.

IGNITION PROBLEMS

No spark from spark plug. Due to the presence of high voltage, this check should only be carried out by an expert.	Check that the electrodes are properly adjusted (0.7÷ 0.8 mm). Check that the electrodes are clean (use pure petrol and a metal brush or an emery cloth). Check the spark plug insulator: if there are any cracks or breakage, replace the spark plug. If the spark plug is in good condition, contact an Authorised Piaggio Service Centre.
--	---

LACK OF COMPRESSION

Spark plug adapter "worn", valve clearance not adequate; worn piston gas rings	Contact an Authorised Service Centre.
--	--

HIGH CONSUMPTION AND LOW PERFORMANCE

Air filter blocked or dirty.	Clean with water and shampoo and impregnate with petrol and specific oil («Air filter removal» section)
------------------------------	---

INEFFICIENT BRAKING

Oil on drum or disc. Worn Pads/ Shoes	Contact an Authorised Service Centre
incorrect rear brake adjustment	Adjust

INEFFICIENT SUSPENSION

Oil leak; worn limit switch bumpers; worn shock absorber attachment points	Contact an Authorised Service Centre
--	---

AUTOMATIC TRANSMISSION PROBLEMS

Deteriorated roller container or belt.	Contact an Authorised Service Centre.
--	--

INCREASED EXHAUST NOISE

Deterioration of the SAS system and/or of the tab	Contact an Authorised Service Centre .
---	---

STAND DOES NOT RETURN TO POSITION

Presence of dirt	Clean and grease
------------------	------------------

STARTER LEVER DOES NOT RETURN TO CORRECT POSITION

Presence of dirt	Clean and grease
------------------	------------------

Fly 50 4T



PIAGGIO®



Chap. 04
Technical data

TECHNICAL DATA

Engine type	Single cylinder, 4-stroke, Piaggio Hi-PER4
Engine capacity	49.9 cc
Bore x stroke	39 X 41.8 mm
Compression ratio	11.5 :1
Width	735 mm
Length	1880 mm
Maximum height	1150 mm
Wheelbase	1340 mm
Fuel	Unleaded petrol
Chassis	Tubular steel frame with sheet metal reinforcements
Fuel tank capacity	approx. 7.2 litres (of which 1.5 l is reserve)
Timing system	Single overhead camshaft (SOHC) with 2 valves
Start-up	Electrical and kick starter
Lubrication	Wet crankcase
Cooling	Forced air circulation.
Depression carburettor	KEIHIN CVK 18
Spark plug	NGK CR 8EB

Alternative spark plug	DENSO U24ESR-NB
Transmission	Automatic variator CVT with torque server.
Clutch	Automatic centrifugal dry clutch
Front suspension	Telescopic mechanical fork, 76mm travel.
Rear suspension	Single hydraulic shock absorber, 72.5-mm travel
Front brake	Disc brake (Ø 200 mm) with hydraulic control (lever on the right end of the handlebar) and floating calliper.
Rear brake	Ø 140mm drum brake
Front wheel rim	Die-cast aluminium alloy 3.50 x 12"
Rear wheel rim	Die-cast aluminium alloy: 3.00"x12"
Front tyre	Tubeless, 120/70-12"
Rear tyre	Tubeless, 120/70 - 12"
Kerb weight	105 kg
Type approval	Euro 2

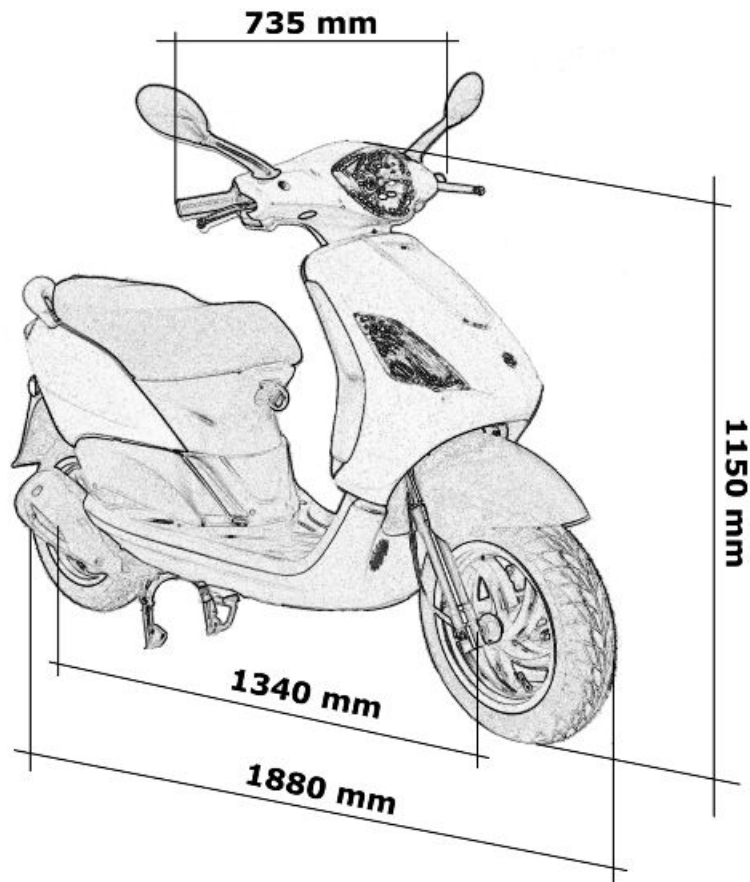

Toolkit

Wrenches: box-spanner (16 mm); 13mm flat wrench; twin screwdriver. The tools are located under the seat in an appropriate container.

Fly 50 4T



PIAGGIO®



**Chap. 05
Spare parts and
accessories**



05_01

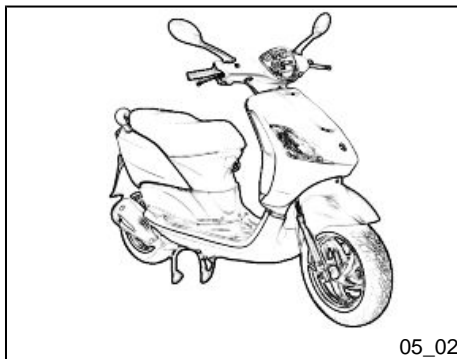

05_02

Warnings (05_01, 05_02)

WARNING



IT IS RECOMMENDED THAT "ORIGINAL PIAGGIO SPARE PARTS" BE USED, AS THESE ARE THE ONLY ONES OFFERING YOU THE SAME QUALITY ASSURANCE AS THOSE INITIALLY FITTED ON THE VEHICLE.

IT SHOULD BE REMEMBERED THAT USING NON-ORIGINAL SPARE PARTS CAUSES YOUR WARRANTY RIGHTS TO EXPIRE.

WARNING



PIAGGIO MARKETS ITS OWN LINE OF ACCESSORIES THAT ARE RECOGNISED AND GUARANTEED FOR USE. IT IS THEREFORE ESSENTIAL TO CONTACT AN AUTHORISED DEALER OR SERVICE CENTRE IN ORDER TO CHOOSE AND FIT ACCESSORIES CORRECTLY. THE USE OF NON-ORIGINAL ACCESSORIES MAY AFFECT THE STABILITY AND OPERATION OF YOUR VEHICLE AND REDUCE SAFETY LEVELS WITH POTENTIAL RISKS FOR THE RIDER.

Fly 50 4T



PIAGGIO®



**Chap. 06
Scheduled
maintenance**

Scheduled servicing table

Adequate maintenance is fundamental to ensuring long-lasting, optimum operation and performance of your vehicle.

To this end, a series of checks and maintenance operations (at the owner's expense) have been suggested, which are included in the summary table on the following page. Any minor faults should be reported without delay to an **Authorised Service Centre or Dealer** without waiting until the next scheduled service to solve it.

It is indispensable to have your vehicle serviced to the prescribed intervals of time, even if you have not reached the predicted mileage. Punctual vehicle servicing is necessary for the correct use of the guarantee. For all further information regarding the Guarantee application modes and the execution of the "Programmed Maintenance" refer to the "Guarantee Booklet".

EVERY 3,000 KM

Engine oil - level check/top-up

EVERY 2 YEARS

Brake fluid - change

AFTER 1,000 KM OR 4 MONTHS

Hub oil - change

Valve clearance - check

Idle speed (*) - adjustment

Throttle control - adjustment

Steering - adjustment

Brake levers - greasing

Brake pads - check condition and wear

Brake fluid level - check

Safety fasteners - check

Electrical system and battery - check

Tyre pressure - check

Vehicle test and brake test - Road test

(*) See instructions in «Idle speed adjustment» section

**AT 6000 KM OR 12 MONTHS, 18000, 30000, 42000,
54000 AND 66000 KM**

Engine oil - change

Hub oil level - check

Spark plug / electrode gap - check

Oil filter (net filter) - clean

Variable speed rollers - check or replacement

Brake pads - check condition and wear

Brake fluid level - check

Electrical system and battery - check

Tyre inflation and wear - Check

Vehicle test and brake test - Road test

AT 12000 KM OR 24 MONTHS AND 60000 KM

Engine oil - change

Hub oil level - check

Spark plug/electrode gap - replacement

Air filter - cleaning

Oil filter (net filter) - clean

Idle speed (*) - adjustment

Throttle control - adjustment

Variable speed rollers - check or replacement

Drive belt - replacement

Odometer gear - greasing

Steering - adjustment

Brake levers - greasing

Brake pads - check condition and wear

Brake fluid level - check

Transmission - lubrication

Safety fasteners - check

Suspensions - check

Electrical system and battery - check

Headlight - adjustment

Tyre inflation and wear - Check

SAS box (sponge) (**) - cleaning

Vehicle test and brake test - Road test

() See instructions in «Idle speed adjustment» section*

*(**) See regulations in the «Secondary air system» section*

A 24000 KM AND 48000 KM

Engine oil - change

Hub oil level - replacement

Spark plug/electrode gap - replacement

Air filter - cleaning

Oil filter (net filter) - clean

Valve clearance - check

Idle speed/carburetion - Adjustment (*)

Throttle control - adjustment

Variable speed rollers - check or replacement

Drive belt - replacement

Cylinder ventilation system - check

Odometer gear - greasing

Steering - adjustment

Brake levers - greasing

Brake pads - check condition and wear

Brake fluid level - check

Transmission - lubrication

Safety fasteners - check

Suspensions - check

Electrical system and battery - check

Headlight - adjustment

Tyre inflation and wear - Check

Vehicle test and brake test - Road test

AT 36000 KM

Engine oil - change

Hub oil level - check

Spark plug/electrode gap - replacement

Air filter - cleaning

Oil filter (net filter) - clean

Idle speed (*) - adjustment

Throttle control - adjustment
Variable speed rollers - check or replacement
Drive belt - replacement
Odometer gear - greasing
Steering - adjustment
Brake levers - greasing
Brake pads - check condition and wear
Flexible brake tubes - replacement
Brake fluid level - check
Transmission - lubrication
Safety fasteners - check
Suspensions - check
Electrical system and battery - check
Headlight - adjustment
Tyre inflation and wear - Check
SAS box (sponge) (**) - cleaning
Vehicle test and brake test - Road test

(*) See instructions in «Idle speed adjustment» section

(**) See regulations in the «Secondary air system» section

AFTER 72,000 KM

Engine oil - change

Hub oil - change

Spark plug/electrode gap - replacement

Air filter - cleaning

Oil filter (net filter) - clean

Valve clearance - check

Idle speed (*) - adjustment

Throttle control - adjustment

Variable speed rollers - check or replacement

Drive belt - replacement

Cylinder ventilation system - check

Odometer gear - greasing

Steering - adjustment

Brake levers - greasing

Brake pads - check condition and wear

Flexible brake tubes - replacement

Brake fluid level - check

Transmission - lubrication

Safety fasteners - check

Suspensions - check

Electrical system and battery - check

 Headlight - adjustment

 Tyre inflation and wear - Check

 SAS box (sponge) (**) - cleaning

 Vehicle test and brake test - Road test

(*) See instructions in «Idle speed adjustment» section

(**) See regulations in the «Secondary air system» section

TABLE OF RECOMMENDED PRODUCTS

Product	Description	Specifications
AGIP ROTRA 80W-90	Rear hub oil	SAE 80W/90 Oil that exceeds the requirements of API GL3 specifications
AGIP CITY HI TEC 4T	Oil to lubricate flexible transmissions (brakes, throttle control and odometer)	Oil for 4-stroke engines
AGIP FILTER OIL	Oil for air filter sponge	Mineral oil with specific additives for increased adhesiveness
AGIP GP 330	Grease for brake levers, throttle, stand	White calcium complex soap-based spray grease with NLGI 2; ISO-L-XBCIB2
AGIP CITY HI TEC 4T	Engine oil	SAE 5W-40, API SL, ACEA A3, JASO MA Synthetic oil
AGIP GREASE MU3	Grease for odometer transmission gear case	Soap-based lithium grease with NLGI 3; ISO-L-XBCHA3, DIN K3K-20

6 Scheduled maintenance

TABLE OF CONTENTS

A

Air filter: 33

B

Battery: 36

Brake: 35, 45, 46

C

Checks: 18

Clock: 9

D

Disc brake: 45

E

Engine oil: 28, 29

F

Fuses: 39

H

Headlight: 42

Horn: 11

Hub oil: 30

I

Identification: 14

K

Key switch: 10

Keys: 13

L

Light switch: 12

M

Maintenance: 27, 61

Mirrors: 44

P

Puncture: 46

R

Refuelling: 18

S

Saddle: 13

Scheduled maintenance: 61

Spark plug: 32

Start-up: 12

Switch: 10–12

T

Technical Data: 53

Toolkit: 57

Top box: 14

Transmission: 23

Tyre pressure: 19

Tyres: 31

V

Vehicle: 7, 47



The descriptions and illustrations given in this publication are not binding. While the basic specifications as described and illustrated in this manual remain unchanged, PIAGGIO-GILERA reserves the right, at any time and without being required to update this publication beforehand, to make any changes to components, parts or accessories, which it considers necessary to improve the product or which are required for manufacturing or construction reasons.

Not all versions/models shown in this publication are available in all countries. The availability of each model should be checked at the official Piaggio sales network.

"© Copyright 2008 - PIAGGIO & C. S.p.A. Pontedera. All rights reserved. Reproduction of this publication in whole or in part is prohibited."

PIAGGIO & C. S.p.A. - After sales

V.le Rinaldo Piaggio, 23 - 56025 PONTEDERA (Pi)