

PIAGGIO WOULD LIKE TO THANK YOU

for choosing one of its products. We have prepared this manual to help you to get the very best from your scooter. Please read it carefully before riding the scooter for the first time. It contains information, tips and precautions for using your scooter. It also describes features, details and devices to assure you that you have made the right choice. We believe that if you follow our suggestions, you will soon get to know your new vehicle and it will serve you well for a long time to come. This booklet forms an integral part of the scooter; should the scooter be sold, it must be transferred to the new owner.

MP3 125



PIAGGIO®

The instructions given in this manual are intended to provide a clear, simple guide to using your scooter; this booklet also details routine maintenance procedures and regular checks that should be carried out on the vehicle at an **authorised Dealer or Service Centre**. The booklet also contains instructions for simple repairs. Any operations not specifically described in this manual require the use of special tools and/or particular technical knowledge: to carry out these operations refer to any **authorised Dealer of Service Centres**.



Personal safety

Failure to completely observe these instructions will result in serious risk of personal injury.



Safeguarding the environment

Sections marked with this symbol indicate the correct use of the vehicle to prevent damaging the environment.



Vehicle intactness

The incomplete or non-observance of these regulations leads to the risk of serious damage to the vehicle and sometimes even the invalidity of the guarantee.

The signs that you see on this page are very important. They are used to highlight those parts of the booklet that should be read with particular care. As you can see, each sign consists of a different graphic symbol, making it quick and easy to locate the various topics.

INDEX

VEHICLE	7	Checks.....	30
Dashboard.....	9	Refuelling.....	31
Analogue instrument panel.....	10	Tyre pressure.....	33
Clock.....	12	Shock absorbers adjustment.....	34
Digital lcd display.....	13	Running in.....	35
Maintenance icons.....	13	Starting up the engine.....	36
MODE button.....	14	Precautions.....	39
Key switch.....	14	Difficult start up.....	39
Locking the steering wheel.....	14	Stopping the engine.....	40
Releasing the steering wheel.....	14	Stand.....	40
Switch direction indicators.....	15	Automatic transmission.....	41
Horn button.....	15	Safe driving.....	41
Light switch.....	16	Front suspension locking system.....	44
Emergency flashing light button.....	16	MAINTENANCE	49
Start-up button.....	17	Engine oil level.....	50
Engine stop button.....	17	Engine oil level check.....	50
Front suspension unlock-lock switch.....	18	Engine oil top-up.....	50
The immobilizer system.....	18	Warning light (insufficient oil pressure).....	50
Keys.....	18	Engine oil change.....	51
Immobilizerdevice enabled indicator led.....	20	Hub oil level.....	52
Operation.....	20	Tyres.....	54
Programming the immobilizer system.....	21	Spark plug dismantlement.....	55
Saddle opening remote control.....	22	Removing the air filter.....	56
Remote control programming.....	22	Air filter cleaning.....	56
Accessing the fuel tank.....	24	Secondary air system.....	57
The saddle.....	25	Cooling fluid level.....	57
Opening the saddle to access the helmet compartment by remote control.....	26	Checking the brake oil level.....	59
Opening the saddle to access the helmet compartment in an emergency.....	27	Braking system fluid top up.....	59
Opening of top box.....	28	Battery.....	61
Identification.....	28	Use of a new battery.....	61
USE	29	Long periods of inactivity.....	62
		Fuses.....	62
		Front light group.....	67

Headlight adjustment.....	68
Front direction indicators.....	71
Rear optical unit.....	72
Number plate light.....	73
Helmet compartment lighting bulb.....	74
Rear-view mirrors.....	74
Idle adjustment.....	74
Front and rear disc brake.....	75
Puncture.....	76
Periods of inactivity.....	77
Cleaning the vehicle.....	77
TECHNICAL DATA.....	83
Kit equipment.....	87
SPARE PARTS AND ACCESSORIES.....	89
Warnings.....	90
PROGRAMMED MAINTENANCE.....	93
Scheduled maintenance table.....	94

MP3 125



PIAGGIO®



**Chap. 01
Vehicle**

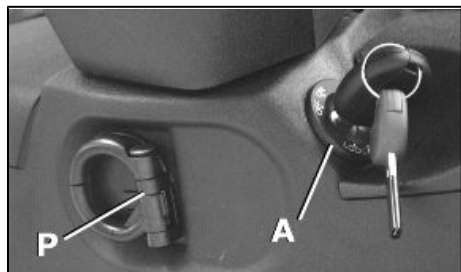

01_01

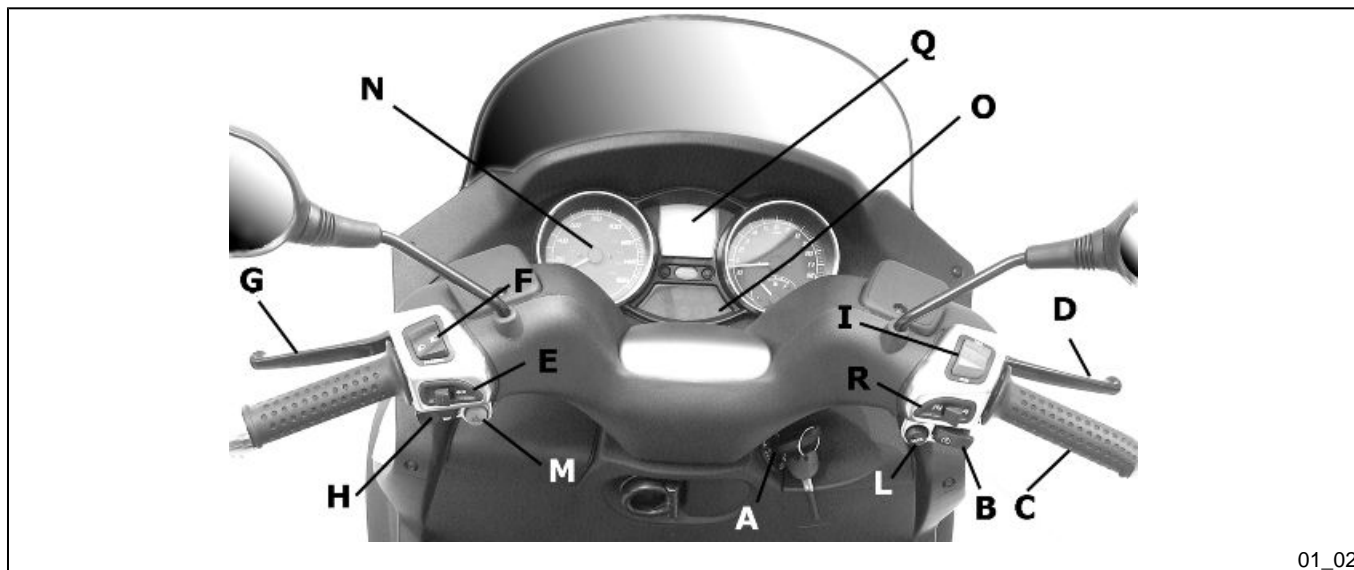

01_02

Dashboard (01_01, 01_02)

A = Ignition key-switch

B = Starter button

C = Throttle control

D = Front brake lever

E = Turn indicator switch

F = Headlight switch

G = Rear brake lever

H = Horn button

I = Engine cut-off switch

L = Mode switch

M = Emergency turn indicator switch

N = Analogue instrument panel

O = Indicator unit

P = Bag hook

Q = Digital instrument panel

R = Front suspension locking-unlocking switch (if available)

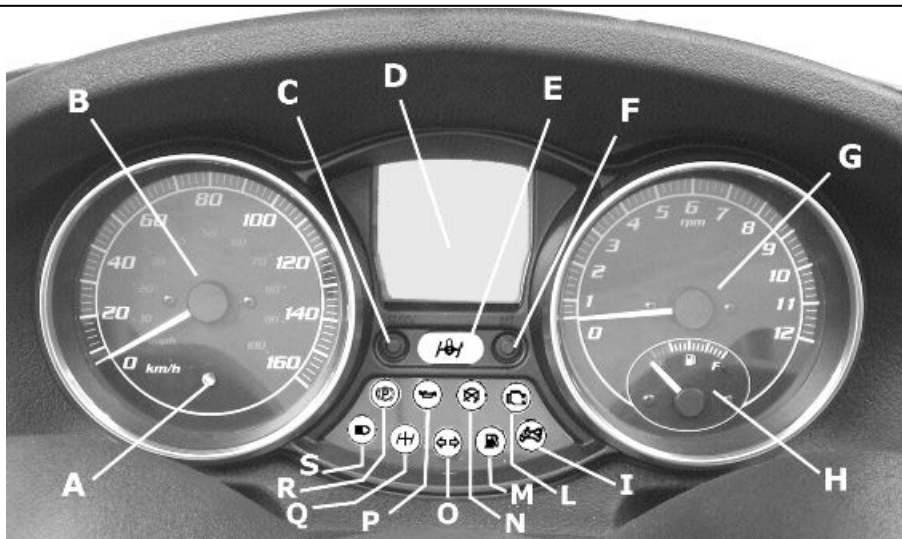

01_03

Analogue instrument panel (01_03)

A = Led immobilizer / anti-theft device

B= Speedometer with twin scale (km/h and mph)

C = CLOCK switch

D = Digital display

E = Front suspension locking system warning light (if available)

F = SET switch

G = Rpm indicator

H = Fuel gauge

I = Warning light for helmet compartment courtesy light on

L = Engine control telltale light and injection system failure warning light

M = Low fuel warning light

N = Engine stop warning light

D= Turn indicator warning light

P = Low oil pressure warning light

Q = Front suspension locking system failure warning light (if available)

R = Warning light for parking brake engaged

C = High-beam warning light

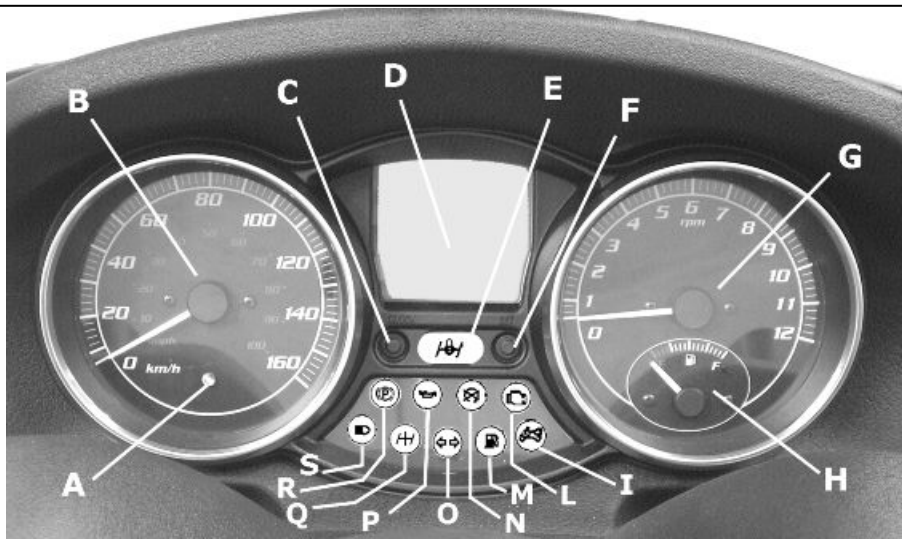

01_04

Clock (01_04)

Pushing the «**CLOCK**» button for less than 1 second displays the following sequence:

- TIME
- DATE

To set the clock push and hold the «**CLOCK**» button longer than 3 seconds.

The numbers showing the hours will begin flashing.

Set the hour using the «**SET**» button. Push the «**CLOCK**» button again and the minutes numbers start flashing.

Set the minutes using the «**SET**» button. Push the «**CLOCK**» button again and the day numbers start flashing.

Set the day with the «**SET**» button. Push the «**CLOCK**» button again and the month numbers start flashing.

Set the month with the «**SET**» button. Push the «**CLOCK**» button again and the year numbers start flashing.

Set the year with the «**SET**» button. Press the «**CLOCK**» button again for 4 seconds to exit the adjustment menu.

During the reset process, not pressing any buttons for a period longer than 8 seconds ends the process automatically and the display shows the modified time.

Digital lcd display (01_05)

A = Total odometer gauge

B = «**BELT**» maintenance icon

C = «**SERVICE**» maintenance icon

D = Engine coolant temperature indicator

E = Trip odometer gauge (A-B) and ambient temperature (selected with the MODE button)

F = TIME-DATE indicator

G = Low fuel warning light

H = Trip odometer gauge (B)

I = Trip odometer gauge (A)

L = Kilometre - mile indicator

Maintenance icons

The icons signal the user that scheduled maintenance operations should be carried out. A flashing «**SERVICE**» icon signals the need to carry out the scheduled maintenance service. A flashing «**BELT**» icon signals the driving belt needs replacing. In any case, vehicle maintenance must be carried out at the kilometre service intervals recommended in this booklet.

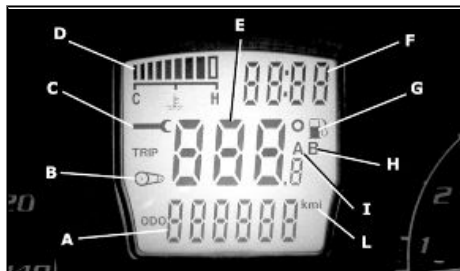

01_05



01_06

WARNING

REFER TO THE «SCHEDULED MAINTENANCE TABLE» FOR FURTHER MAINTENANCE OPERATIONS

***MODE* button (01_06)**

Pushing the «MODE» switch **(N)** for less than a second displays the following function sequence:

1. Trip odometer "A"
2. Trip odometer "B"
3. Ambient temperature "°"

Push the «MODE» switch **(N)** for longer than 3 seconds to zero set the trip odometer

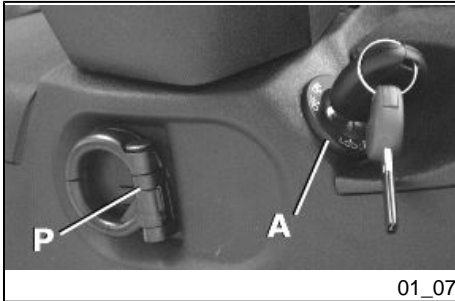
**Key switch (01_07, 01_08)**

1. **LOCK** = Ignition disabled, extractable key, mechanical antitheft device enabled. The parking brake cannot be released when pressed and cannot be pressed when released.
2. **« OFF »** = Ignition disabled, extractable key, mechanical antitheft device disabled and enabled/disabled parking brake.
3. **ON** = Ready to start, non-extractable key, mechanical antitheft device disabled.
4. **«HELMET COMPARTMENT OPENING»** = Helmet compartment opening position. Press the key when in "OFF" or "ON" and turn it anticlockwise.
5. **«FUEL TANK COVER OPENING»** = Fuel tank cover opening position. Press the key when in "OFF" or "ON" and turn it clockwise.

Locking the steering wheel

Turn the handlebar to the left as far as it will go, turn the key to position "**LOCK**" and remove the key.

Releasing the steering wheel

Reinsert the key and turn it to **«OFF»**.

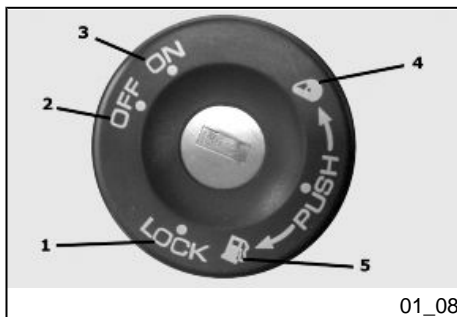

01_08

CAUTION

DO NOT TURN THE KEY TO «LOCK» OR «OFF» WHILE RIDING.

Switch direction indicators (01_09)

Lever towards "S" = Left turn indicator is switched on;

Lever towards "D" = Right turn indicator is switched on;

The lever «B» automatically returns to «0» and the turn indicators remain on; press the lever to turn them off.

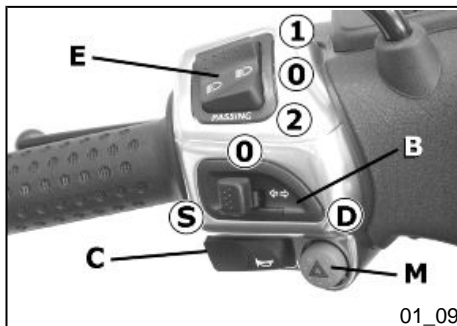

01_09

Horn button (01_10)

Push the «C» button to sound the horn.

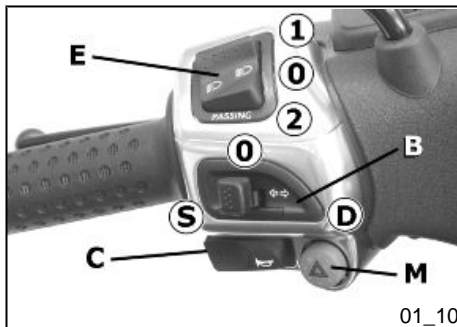

01_10

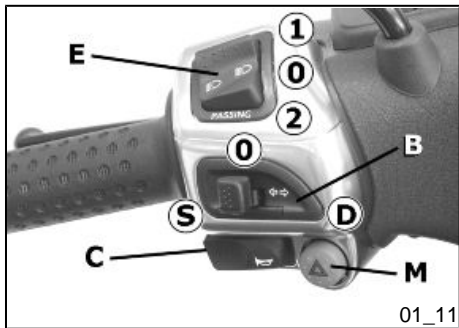

Light switch (01_11)

0 = Low-beam light

1 = High beam light

2 = Passing (flashing)

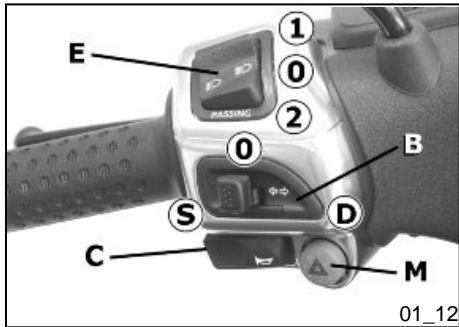

Emergency flashing light button (01_12)

It enables the activation of the 4 turn indicators simultaneously. The control «M» can be enabled only with the key set to «ON», but once enabled, it keeps functioning even if the key is set to «OFF» or «LOCK». To disable this function, simply turn the key switch to «ON».

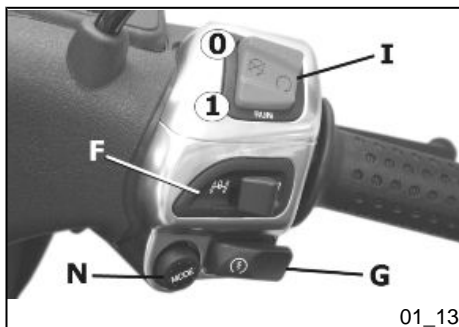

Start-up button (01_13)

Turn the key to «ON».

Turn the RUN/OFF switch to «RUN».

Pull one of the two brake levers.

Press the «G» switch to start the engine.

Warning, in vehicles fitted with a suspension locking system, the vehicle will start but will remain at idling speed if the rider is not seated on the saddle in riding position.

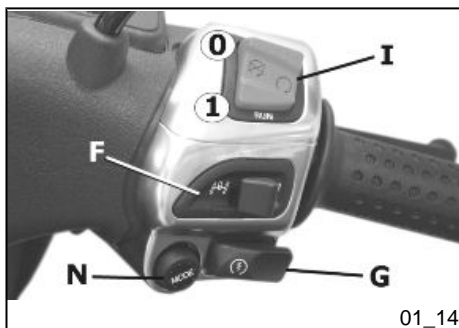

Engine stop button (01_14)

Functioning of the engine cut-off switch "I":

0 = OFF

1 = RUN

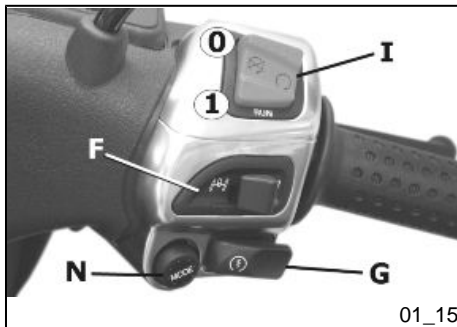

Front suspension unlock-lock switch (01_15)

The «F» switch engages and disengages the front suspension locking system in models where the system is available.

As the topic is so complex, find the instructions for using this control in the **Use** chapter.

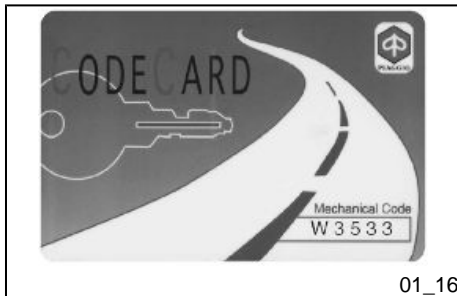

The immobilizer system

In order to enhance theft protection, the scooter is equipped with a **«PIAGGIO IMMOBILIZER»** electronic engine locking device that is activated automatically when the starter key is removed. Upon start-up, the **«PIAGGIO IMMOBILIZER»** system checks the starter key, and only if this key is recognised will the immobilizer system allow the scooter to be started.

Keys (01_16, 01_17, 01_18)

Two types of keys come with the vehicle.

The red-handgrip key "A" is the **"MASTER"** key.

Only a single copy of this key is supplied, which is necessary to program all your other keys and for your dealer to perform some maintenance operations. For this reason it is advised that it be used only in exceptional circumstances.

The black key "B" (single copy supplied) is used for normal operations such as:

- engine start up
- open the rear glove-box and the saddle (with remote control)

Together with the two keys, you will be given a CODE CARD bearing the same code imprinted onto the two keys.

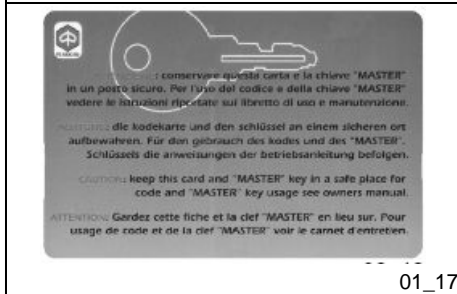

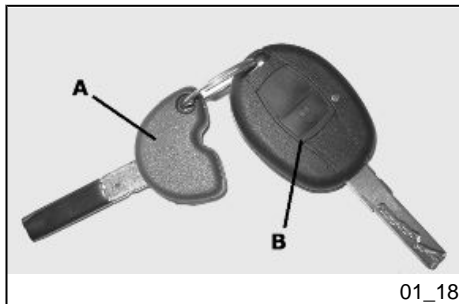

01_18

WARNING



LOSING THE RED KEY PREVENTS ANY REPAIRS OF THE "PIAGGIO IMMOBILIZER" SYSTEM AND THE ENGINE CONTROL UNIT.

WARNING



KEEP THE "CODE CARD" AND THE RED HANDGRIP KEY IN A SAFE PLACE (NOT ON YOUR VEHICLE).

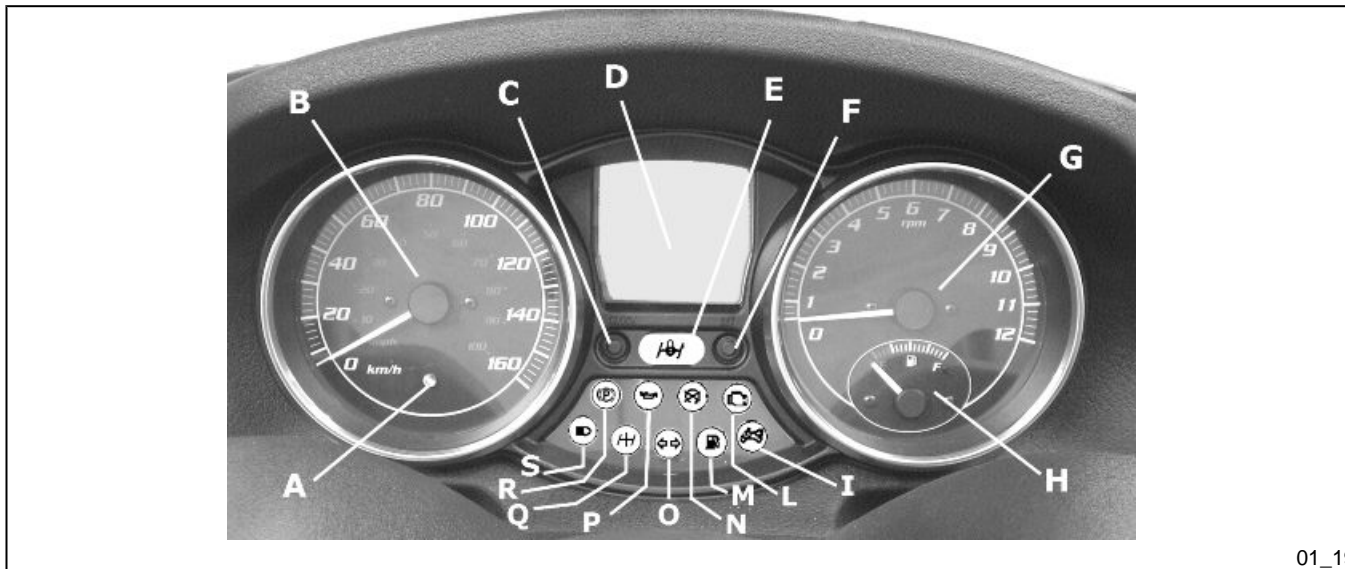

01_19

Immobilizer device enabled indicator led (01_19)

Activation of the "**PIAGGIO IMMOBILIZER**" system is signalled by a flashing «A» indicator. In order to reduce battery discharge, the indicator LED turns off automatically after 48 hours of uninterrupted functioning. Should the signal led system break down in its flashing function, give information about the type of problem to an **Authorised Piaggio-Gilera Service Centre**.

Operation

Every time the starter key is removed in the "**OFF**" or "**LOCK**" position, the safety system activates the immobilizer system. Turning the key to "**ON**" disables the engine lock, provided that the safety system recognises the code transmitted by the key. If the code is not recognised, turn the key first to "**OFF**" and then to "**ON**"; if the lock cannot be disabled, try with the other key supplied (red-coloured). If the engine cannot be started, contact an **Authorised Piaggio Service Centre**, which is provided with the electronic equipment required to detect and repair the system.

When additional keys are required, please note that data storage (up to 7 keys max.) must be done on all keys, both new ones and existing ones.

Take the red-handgrip key and all the black keys supplied to an **Authorised Piaggio Service Centre**.

The codes of keys not submitted for the new storage procedure are deleted from the memory. Any lost keys will therefore not be enabled to start the engine.

WARNING



EACH KEY HAS ITS OWN AND UNIQUE CODE, WHICH MUST BE STORED BY THE SYSTEM CONTROL UNIT.

VIOLENT SHOCKS MAY AFFECT THE ELECTRONIC COMPONENTS OF THE KEY.

IF OWNERSHIP OF THE VEHICLE IS TRANSFERRED, THE RED-HANDGRIP KEY (AS WELL AS THE OTHER KEYS) AND THE "CODE CARD" MUST ALSO BE TRANSFERRED TO THE NEW OWNER.

Programming the immobilizer system

Below is described the procedure to follow for programming the **PIAGGIO IMMOBILIZER** system and/or for storing other key codes. The programming procedure should be carried out with the engine stop switch set to «**RUN**».

Procedure start - red key

Insert the red-handgrip key in the switch key (in "**OFF**" position) and turn it to "**ON**". After 1 - 3 seconds, turn the key to "**OFF**" again and pull it out.

Intermediate step - black key

After pulling out the red key, insert the black key within 10 seconds and promptly turn it to «**ON**». After 1-3 seconds, turn the key to "**OFF**" again and pull it out. In this way, a maximum of 7 black keys can be programmed by repeating the above procedure keeping the indicated times.

Final step - red key

After pulling out the last black key, insert the red key again and turn it to "**ON**" (this operation should be performed within 10 seconds of pulling out the previous key). Leave it in this position for 1 to 3 seconds and return it to the «**OFF**» position.

Proper programming check

Insert the red key disabling the transponder (i.e., tilt the key cap by 90°) and turn the key to "ON". Perform the engine start-up operation. Ensure that the engine does not start. Insert the black key and repeat the start-up operation. Check that engine starts.

WARNING

SHOULD THE ENGINE START WITH THE RED KEY (WITH TRANSPONDER OFF), OR IN THE EVENT OF WRONG OPERATION DURING PROGRAMMING, REPEAT THE PROCEDURE FROM THE BEGINNING.

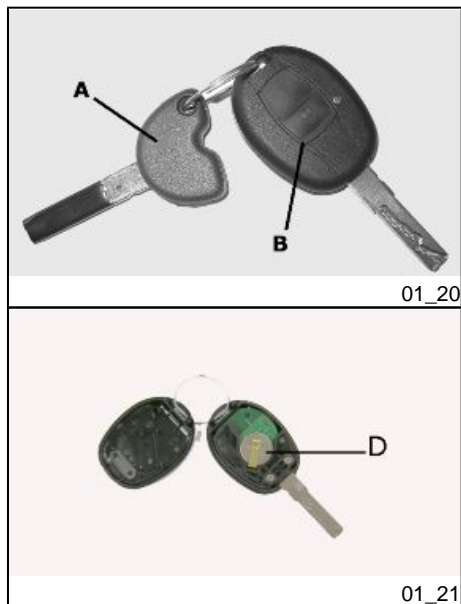

Saddle opening remote control (01_20, 01_21)

The scooter is fitted with a remote control to open the saddle. This remote control is supplied together with the keys and it has been programmed to control the opening device control unit at the manufacturing stage. If the remote control is lost, a new one can be requested and programmed at any **Authorised Service Centre**. The remote control is powered by inner batteries that get discharged after extended used; If the green LED turns on when the button is pressed, the remote control is working properly. You may need to replace the batteries if the remote control fails or if its range of operation is reduced. To separate the two halves of the remote control, insert the blade of a plain slot screwdriver at one point on the edge and slide it all around. When the remote control is open, remove the **two batteries** from the contact terminal. Install the two new **CR1616 3V** batteries with the positive pole facing the contact terminal.

Reassemble the remote control by pressing the two clip-on halves gently with your fingers.

To open the saddle without the remote control, follow the procedure described in the «Emergency Saddle Opening» section.

Remote control programming

Follow these steps to program the remote controls:

1. Insert the remote control key to be programmed in the steering lock key block.

2. Turn the key to «ON», press the button on the remote control, release the button, turn the key back to «OFF» from the «ON» position, all within 4 seconds.

3 Wait 1 to 8 seconds.

4. Repeat steps 2 and 3 for 4 times without removing the key.

The control unit confirms the programming has been successfully executed by opening the saddle.

WARNING



TO STORE THE OTHER REMOTE CONTROLS TO MEMORY, (MAXIMUM 8), YOU NEED TO REPEAT THE WHOLE PROCEDURE AGAIN. FAILURE TO CARRY OUT THESE OPERATIONS WITHIN THE INDICATED TIMES WILL RESULT IN THE AUTOMATIC CANCELLATION OF THE PROCESS FOR PROGRAMMING THE REMOTE-CONTROLLED KEYS.

WARNING



AVOID PRESSING THE REMOTE CONTROL BUTTON MORE THAN ONCE WHEN FAR AWAY FROM THE SCOOTER. THE SYNCHRONISM BETWEEN THE REMOTE CONTROL AND THE RECEIVER CAN BE IMPAIRED. SHOULD THIS BE THE CASE, REPEAT THE PROGRAMMING PROCEDURE. DO NOT KEEP THE REMOTE CONTROL IN PLACES WITH TEMPERATURES EXCEEDING 60° C THE BATTERY WILL RUN DOWN TOO QUICKLY.

WARNING



TO AVOID BATTERY DISCHARGE, THE SADDLE OPENING REMOTE CONTROL RADIO RECEIVER DEACTIVATES 7 DAYS AFTER THE LAST TIME THE VEHICLE WAS SHUT OFF.

JUST TURN THE KEY TO «ON» TO REACTIVATE THE RECEIVER.

Accessing the fuel tank (01_22, 01_23)

To open the fuel tank cover, set the key to «OFF» or « ON», then press and turn it clockwise.

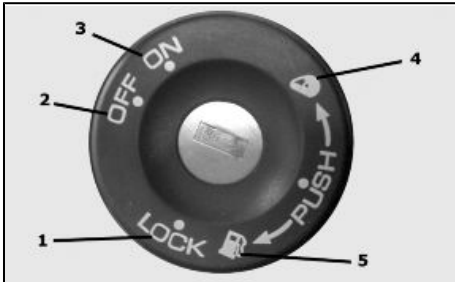

01_22



01_23

The saddle (01_24, 01_25, 01_26)

The saddle is supplied with a protection cover which may be used in case of rain.

Lift the saddle and extract the cover from its housing, then extend it over the whole length of the saddle, starting from the front-end; do not over stretch the cover to avoid tearing the material; close the saddle.

CAUTION



DO NOT USE THE VEHICLE WITHOUT THE PROTECTION COVER.



01_24



01_25

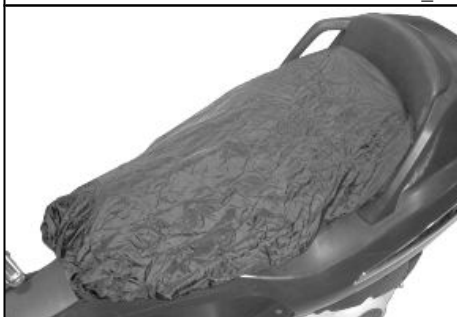

01_26



01_27

Opening the saddle to access the helmet compartment by remote control (01_27)

When the key is in «**LOCK**» or «**OFF**» position you can open the saddle using the remote control. The saddle cannot be opened only when the key is set to "ON".

WARNING



OBJECTS INAPPROPRIATELY ARRANGED INSIDE THE HELMET COMPARTMENT MAY DEFORM THE SADDLE CAUSING THE COURTESY LIGHT TO REMAIN ON AND THIS WILL DISCHARGE THE BATTERY. IN ANY CASE, THE WARNING LIGHT "I" ON THE INSTRUMENT PANEL SIGNALS IF THE LIGHT IS ON OR OFF.

WARNING

THE REMOTE CONTROL OPERATES WITHIN A DISTANCE OF ABOUT 3/5 METRES WITH FULLY CHARGED BATTERIES. WHEN YOU ARE NEAR THE SCOOTER, HANDLE THE REMOTE CONTROL CAREFULLY SO AS TO AVOID UNINTENTIONAL OPENING OF THE SADDLE. REFER TO THE «OPENING THE SADDLE WITH REMOTE CONTROL» SECTION TO REPLACE BATTERIES.

Opening the saddle to access the helmet compartment in an emergency (01_28, 01_29)

If the remote control battery or the vehicle battery is discharged, follow these steps to open the saddle:

1. Open the rear case with the key switch
2. Softly press with your hand on the point shown in the photo and in the sense indicated by the arrow inside the helmet compartment until the saddle closing device springs

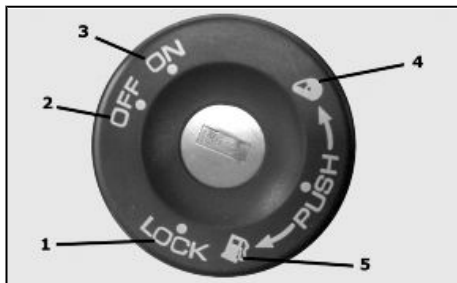

01_28



01_29

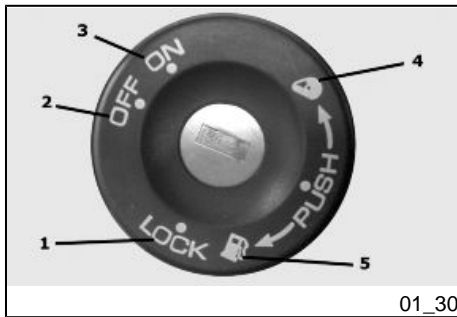

Opening of top box (01_30)

With the switch set to «OFF» or «ON», press the key and turn it anticlockwise, towards position «4».

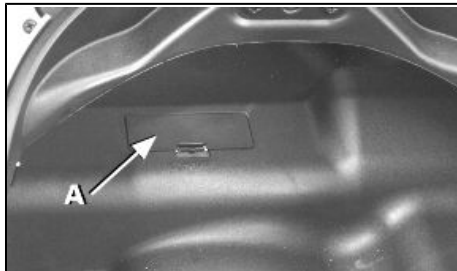

Identification (01_31, 01_32)

The identification registration numbers consist of a prefix stamped on the chassis and engine "B" respectively, followed by a number. These numbers must always be indicated on spare parts requests. To read the chassis number, remove the relevant port "A" in the helmet compartment. We recommend checking that the chassis registration number stamped on the vehicle corresponds with that on the vehicle documentation.

CAUTION



BE REMINDED THAT ALTERING IDENTIFICATION REGISTRATION NUMBERS CAN LEAD TO SERIOUS PENAL SANCTIONS (IMPOUNDING OF THE VEHICLE, ETC.).

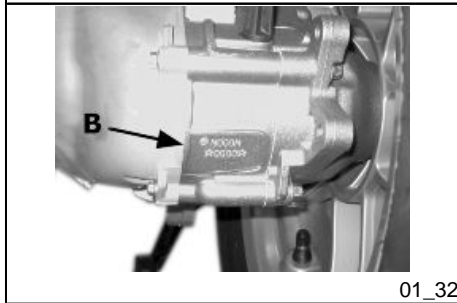

MP3 125



PIAGGIO®



Chap. 02
Use

Checks

Before using the vehicle, check:

1. There is enough fuel in the fuel tank.
2. The correct fluid level for front and rear brakes.
3. The tyres are properly inflated.
4. The correct functioning of the front and rear brakes.
5. The oil level in the transmission casing.
6. The engine oil level.
7. The coolant level.
8. The correct functioning of the tail lights, the turn indicators, the stop light and the license plate light and the headlight turn on adequately (warning: the headlight works only when the scooter is in motion).
9. The correct functioning of the parking brake.
10. The correct functioning of the front suspension and the suspension locking system (if available).

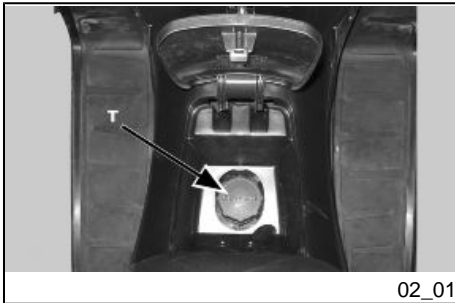



02_02

Refuelling (02_01, 02_02)

Fuel: Open the access door to the fuel tank cap and remove the cap «T».

Recommended fuel: Unleaded petrol (95 octane min.). The instrument «H» indicates fuel level and the warning light «M» indicates the reserve.

WARNING



**SWITCH OFF THE ENGINE BEFORE REFUELLING WITH PETROL.
PETROL IS HIGHLY INFLAMMABLE.**

DO NOT SMOKE AND KEEP OPEN FLAMES AT A DISTANCE:FIRE HAZARD.

DO NOT INHALE FUEL FUMES.

DO NOT ALLOW PETROL TO COME INTO CONTACT WITH HOT ENGINE OR ANY PLASTIC PARTS.

CAUTION



PETROL DAMAGES THE PLASTIC PARTS OF THE BODYWORK.

WARNING



DO NOT RIDE WITH THE FUEL TANK ALMOST EMPTY, LACK OF FUEL CAN DAMAGE THE CATALYTIC CONVERTER.

CAUTION



USING NON-RECOMMENDED PETROL REDUCES THE EFFICIENCY OF THE EXHAUST AND FUEL SUPPLY SYSTEMS.

CAUTION



DO NOT USE THE VEHICLE TO THE COMPLETE EXHAUSTION OF THE FUEL; IN THE EVENT THAT THIS SHOULD OCCUR, DO NOT ATTEMPT TO START THE ENGINE. TURN THE KEY SWITCH TO OFF AND TOP-UP THE TANK AS SOON AS POSSIBLE. FAILURE TO FOLLOW THESE GUIDELINES COULD DAMAGE THE FUEL PUMP AND/OR THE CATALYTIC CONVERTER.

WARNING

IT IS HIGHLY INADVISABLE TO REFUEL USING METHODS OTHER THAN NORMAL FUEL PUMPS. IF PETROL IS NOT COMPLETELY CLEAN, IT CAN DAMAGE THE FUEL SUPPLY SYSTEM FILTERS.

CAUTION

USING OILS OTHER THAN THOSE RECOMMENDED CAN SHORTEN THE LIFE OF THE ENGINE.

Characteristic**Fuel tank capacity**

Tank capacity: ~12 l (approximate value)

Fuel reserve

2 l (approx.)

Tyre pressure (02_03)

Check the tyre pressure and wear periodically (roughly every 500 km). The tyres are equipped with wear indicators; the tyres should be replaced as soon as these indicators become visible on the tyre tread. Also check that the tyres do not show signs of splitting at the side or irregular tread wear; if this occurs, go to an authorised workshop or at least a workshop equipped to perform the replacement.

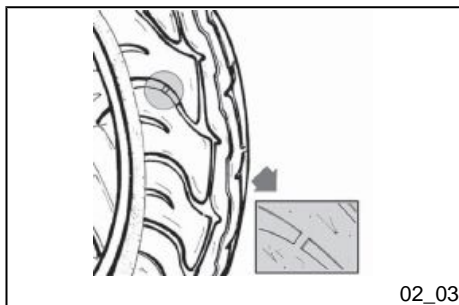

CAUTION

TYRE PRESSURE SHOULD BE CHECKED WHEN TYRES ARE COLD. INCORRECT TYRE PRESSURE CAUSES ABNORMAL TYRE WEAR AND MAKES RIDING DANGEROUS.

TYRES MUST BE REPLACED WHEN THE TREAD REACHES THE WEAR LIMITS SET FORTH BY LAW.

Characteristic**Front tyre pressure (rider)**

Front tyre pressure (rider): 1.6 bar

Front tyre pressure (rider and passenger)

Front tyre pressure (rider and passenger): 1.8 bar

Rear tyre pressure (rider)

Rear tyre pressure (rider): 2 bar

Rear wheel pressure (rider and passenger):

Rear tyre pressure (rider and passenger): 2.4 bar

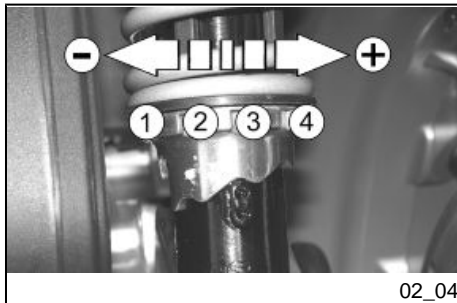

02_04

Shock absorbers adjustment (02_04)

The preloading of the springs can be adjusted to 4 positions using the ring nut located in the lower part of the shock absorbers and the specific spanner supplied.

Position 1: Minimum preload: driver only

Position 2: medium preloading: driver only

Position 3: medium preloading: rider and passenger

Position 4: Maximum preload: driver, passenger, and luggage.

In order to carry out this operation you will need to use the specific spanner in the kit.

CAUTION



RIDING THE VEHICLE WITH THE SPRING PRELOADING NOT CORRECTLY SET FOR THE RIDER AND POSSIBLE PASSENGER, COULD REDUCE THE COMFORT OF THE RIDE AND THE PRECISION OF THE STEERING.

WARNING



WE RECOMMEND WEARING GLOVES WHILE CARRYING OUT THIS OPERATION IN ORDER TO AVOID INJURIES.

WARNING



WE STRONGLY RECOMMEND NOT TO ADJUST BOTH SHOCK ABSORBERS WITH DIFFERENT PRELOADING

Running in

DURING THE FIRST 1000 KM DO NOT RIDE THE VEHICLE OVER 80% OF ITS MAX. SPEED. AVOID OPENING THE THROTTLE GRIP COMPLETELY OR KEEPING A CONSTANT SPEED ALONG LONG SECTIONS OF ROAD. AFTER THE FIRST 1000 KM INCREASE SPEED PROGRESSIVELY, IF POSSIBLE, UNTIL THE MAXIMUM PERFORMANCE IS OBTAINED.

CAUTION



IN ORDER TO AVOID DAMAGING THE VEHICLE, PLEASE COMPLY WITH THE RULES LISTED ABOVE.

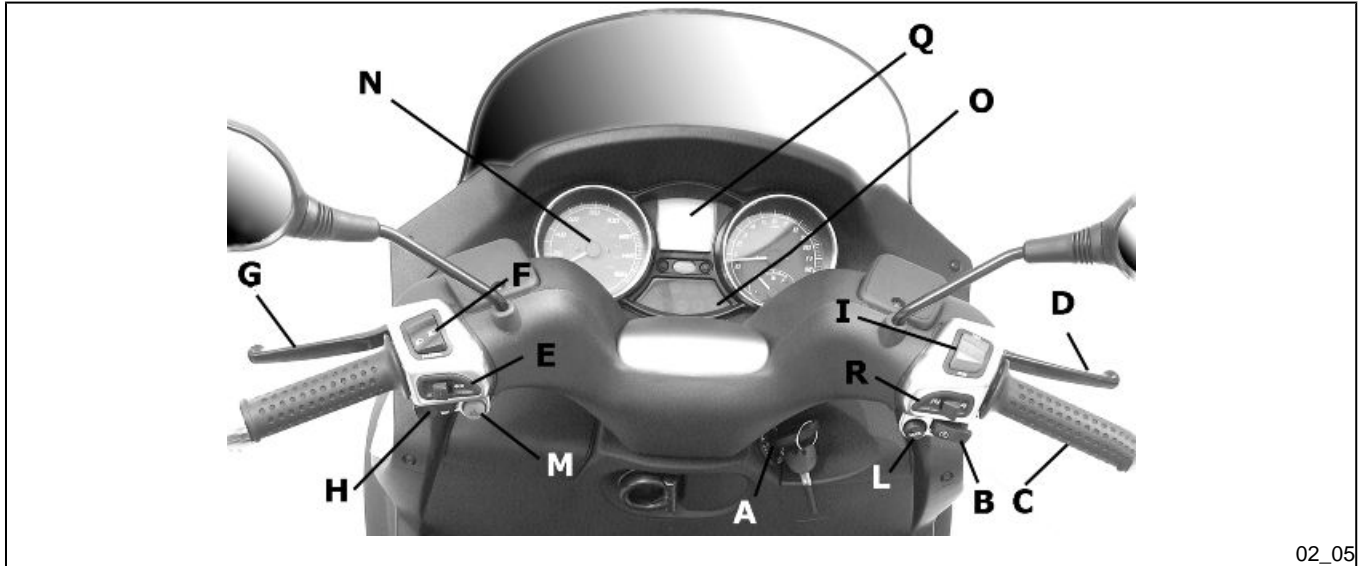

02_05

Starting up the engine (02_05)

The vehicle is supplied with an ignition cut-off system, activated by the emergency cut-off switch. The engine cannot be started if the ignition cut-off switch is in the **OFF position**

A running engine automatically switches off when the ignition cut-off switch is set to **OFF**.

The scooter is equipped with automatic transmission with direct drive, so that starting is effected by turning the throttle grip to idle speed; to start-off from still, progressively twist the throttle grip. The vehicle is equipped with an electrical fuel pump that switches on automatically as soon as the engine is started. To start the vehicle, before pressing the starter button «**B**», pull and keep pulled the front brake lever «**D**» or the rear brake lever «**G**» that operates the corresponding ignition consent switches. Besides, if the vehicle has a front suspension locking system, a sensor placed under the saddle will prevent vehicle motion, but not ignition, if the rider is not seated in riding position.

1. Rest the vehicle on its centre-stand, ensuring the rear wheel is not touching the ground.
2. Maintain the throttle "**C**" completely untwisted.
3. Insert the key into the ignition switch "**A**" and turn it onto the **ON** position.
4. Make sure that the "**I**" switch is set onto the **ON** position.
5. Pull either the front, "**D**", or rear brake lever, "**G**", while pressing the starter button "**B**".

WARNING



THE AUTOMATIC TRANSMISSION MAKES THE REAR WHEEL TURN EVEN WHEN THE THROTTLE IS SLIGHTLY TWISTED. RELEASE THE BRAKE CAREFULLY AFTER STARTING, AND THEN ACCELERATE GRADUALLY.

CAUTION



DO NOT START-UP THE ENGINE IN CLOSED AREAS BECAUSE EXHAUST GASES ARE TOXIC.

CAUTION



DUE TO THE HIGH TEMPERATURES THE CATALYTIC CONVERTER CAN REACH, ALWAYS TAKE CARE, WHEN PARKING THE SCOOTER, THAT THE EXHAUST DOES NOT COME INTO CONTACT WITH FLAMMABLE MATERIALS, TO AVOID SERIOUS BURNS.

CAUTION



DO NOT SWITCH OFF THE ENGINE WHILE THE VEHICLE IS MOVING. UNBURNED FUEL COULD ENTER THE CATALYTIC CONVERTER AND BURN, CAUSING IT TO OVERHEAT AND POSSIBLY DESTROYING IT.

CAUTION



NEITHER PUSH THE STARTER BUTTON NOR TURN THE KEY SWITCH TO «ON» WHEN THE TANK IS EMPTY SINCE THE START-UP SYSTEM MAY GET DAMAGED.

WARNING



NEVER TRY TO START-UP THE ENGINE WITH THE THROTTLE GRIP TWISTED. THIS MAY LEAD TO LOSING CONTROL OF THE VEHICLE AND TO ROLLOVER, WITH CONSEQUENT SERIOUS OR, IN SOME CASES, LETHAL INJURIES.

Precautions

WARNING



NEVER STRESS THE ENGINE AT LOW TEMPERATURES IN ORDER TO AVOID POSSIBLE DAMAGE. BE CAREFUL NEVER TO EXCEED THE MAXIMUM SPEED WHILE RUNNING DOWNHILL, IN ORDER TO AVOID DAMAGING THE ENGINE. IN ANY CASE, IN ORDER TO PRESERVE THE ENGINE FROM PROLONGED EXCESSIVE REVOLUTIONS, THE REVOLUTION LIMITER WILL BE ACTIVATED IF THE ENGINE SPEED EXCEEDS THE ESTABLISHED THRESHOLD. DO NOT ACTIVATE THE REVOLUTION LIMITER RECURRENTLY SO AS TO AVOID DAMAGING THE CATALYTIC CONVERTER.

WARNING



AFTER A LONG DISTANCE COVERED AT THE MAXIMUM SPEED, DO NOT STOP THE ENGINE IMMEDIATELY, BUT LET IT RUN AT IDLE FOR A FEW SECONDS.

Difficult start up

In the rare case of flooding the engine, to facilitate start-up, it is possible to try to put the vehicle into action with the gas hand grip partially or completely open. It is however necessary, once the engine is started, to take your vehicle to an **Authorised Service Centre** to determine the cause of this problem and to re-establish the vehicle proper functioning.

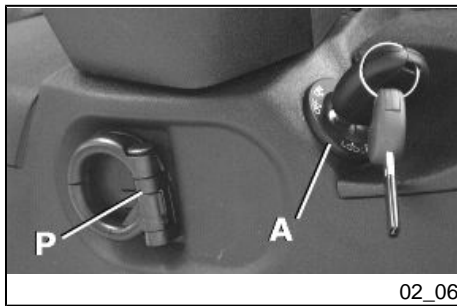

02_06

Stopping the engine (02_06)

Fully untwist the throttle grip, then rotate the key in the switch «A » to «KEY OFF» (extractable key).

CAUTION



DUE TO THE HIGH TEMPERATURES THE CATALYTIC CONVERTER CAN REACH, ALWAYS TAKE CARE, WHEN PARKING THE SCOOTER, THAT THE EXHAUST DOES NOT COME INTO CONTACT WITH FLAMMABLE MATERIALS, TO AVOID SERIOUS BURNS.

CAUTION



DO NOT SWITCH OFF THE ENGINE WHILE THE VEHICLE IS MOVING. UNBURNED FUEL COULD ENTER THE CATALYTIC CONVERTER AND BURN, CAUSING IT TO OVERHEAT AND POSSIBLY DESTROYING IT.

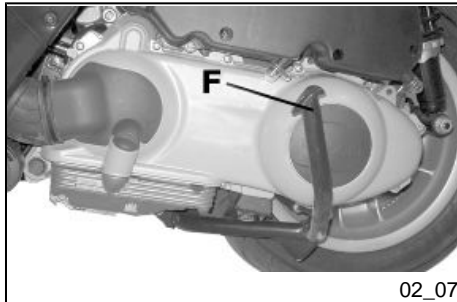

02_07

Stand (02_07)

CENTRE STAND

With your foot push the projection of the centre stand «F » while lifting the vehicle backwards, holding onto the side handles.

Automatic transmission

To ensure simple, pleasurable riding, the vehicle is equipped with automatic transmission with regulator and centrifugal clutch. The system is designed to provide the best performance (acceleration and consumption) while riding on both flat roads and uphill.

If you have to stop on an uphill slope (traffic lights, traffic jam, etc.) **use only the brake to keep the vehicle still, leaving the engine running at idle speed. Using the engine to keep the vehicle still can cause the clutch to overheat, due to the friction of the clutch masses against the capstan. Besides, avoid accelerating with the hand brake engaged.** It is therefore recommended to avoid conditions of prolonged clutch slippage (besides those previously indicated) like driving uphill fully laden on steep slopes or starting off with driver and passenger at slopes greater than 25%.

Observe the following precautions if the clutch overheats:

1. Do not continue riding in such conditions.
2. Let the clutch cool down with the engine at idle speed for a few minutes.

Safe driving

In the following we offer some simple advice, that will allow for the daily use of your scooter in greater safety and peace of mind. Your skill and your mechanical knowledge are the basis of a safe ride. We recommend trying out the vehicle in traffic - free zones, in order to acquire a good knowledge of the vehicle itself.

1. Before riding off, remember to put on your helmet and fasten it correctly.
2. Reduce speed on rough roads and drive with care.
3. After driving on a long stretch of wet road without using the brakes, the braking effect is initially lower. In these conditions, it is a good idea to apply the brakes from time to time.
4. Avoid riding off by mounting the scooter when resting on the support. In any case, the rear wheel should not be turning when it comes into contact with the ground, in order to avoid abrupt departures.

5. If driving over roads affected by sand, mud, snow mixed with salt, etc. we recommend cleaning the brake disc with a non-corrosive detergent frequently in order to prevent corrosive particles from building up in the holes, which may cause early brake pad wear.

CAUTION

ALWAYS RIDE WITHIN YOUR LIMITS RIDING UNDER THE INFLUENCE OF ALCOHOL OR OTHER DRUGS AND CERTAIN MEDICATIONS IS EXTREMELY DANGEROUS.

CAUTION

IN ORDER TO PREVENT ANY ACCIDENTS RIDE VERY CAREFULLY AFTER ADDING ACCESSORIES AND WHILE CARRYING LUGGAGE. ADDING ACCESSORIES AND LUGGAGE CAN REDUCE THE VEHICLE'S STABILITY, PERFORMANCE AND SAFETY DURING USE.

WARNING

NEVER RIDE THE SCOOTER EQUIPPED WITH ACCESSORIES (TOP BOX AND/OR WINDSHIELD) AT A SPEED HIGHER THAN 100 km/h.

THE SCOOTER CAN BE RIDDEN AT A HIGHER SPEED WITHOUT THE ACCESSORIES MENTIONED BEFORE WITHIN THE LIMITS ESTABLISHED BY LAW.

IF THERE SHOULD BE NOT-PIAGGIO ACCESSORIES INSTALLED, OR AN ABNORMAL LOAD, OR IF THE SCOOTER IS NOT IN A GENERALLY GOOD CONDITION, OR WHENEVER WEATHER CONDITIONS DEMAND IT, SPEED SHOULD BE REDUCED FURTHER.

CAUTION

DO NOT ADJUST THE MIRRORS WHILE RIDING. THIS COULD CAUSE YOU TO LOOSE CONTROL OF THE VEHICLE.

CAUTION

ANY CHANGES TO THE VEHICLE PERFORMANCE AS WELL AS ALTERATIONS TO ORIGINAL STRUCTURAL PARTS IS STRICTLY FORBIDDEN BY LAW, AND RENDERS THE VEHICLE NO LONGER CONFORMING TO THE APPROVED TYPE AND DANGEROUS FOR RIDING.

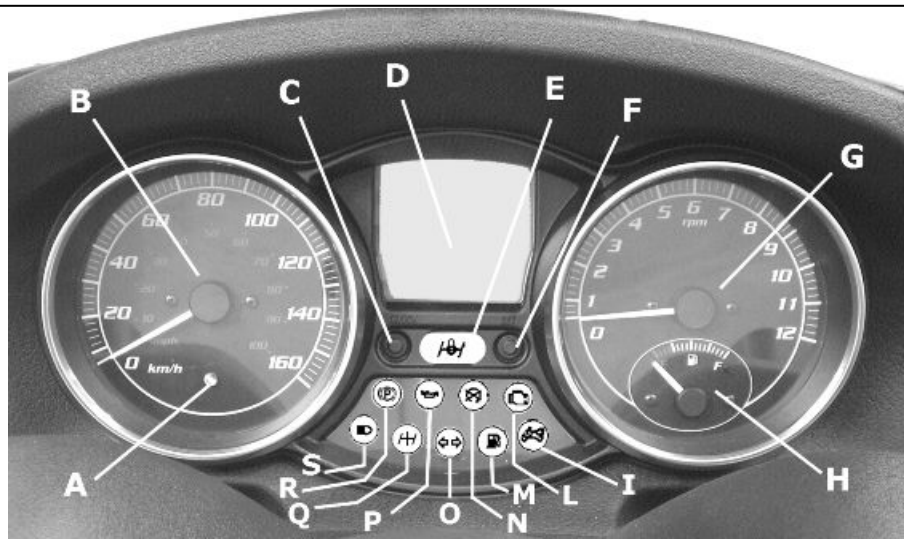

02_08

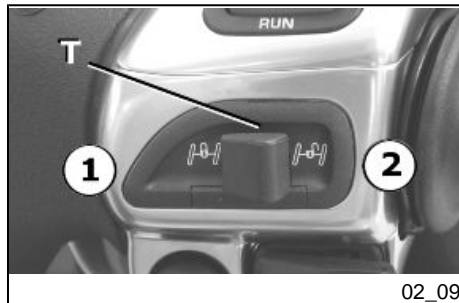

02_09

Front suspension locking system (02_08, 02_09, 02_10, 02_11, 02_12)

The following point corresponds only to versions with front suspension locking system.

The front suspension locking system simply prevents vehicle tilting when the "T" switch is pressed. The vehicle can be stopped without your feet touching the ground.

The warning light "E" starts flashing when the key switch is set to "ON". This means that the system is enabled for locking activation.

When the "T" switch is turned to "1", a continuous sound alarm signals that the locking system is engaged and, at the same time, the warning light "E" turns steadily on.



02_10

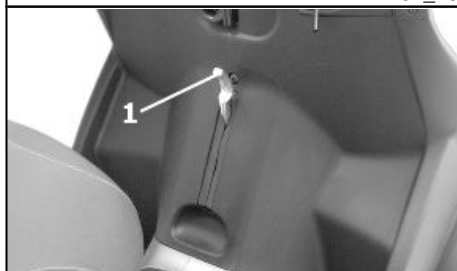

02_11

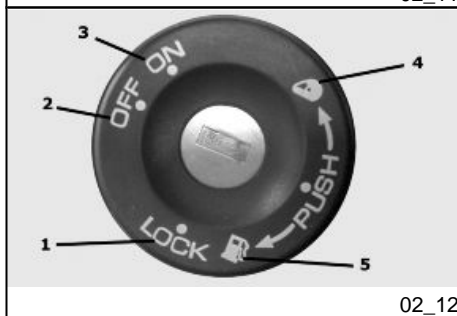

02_12

When the "T" switch is turned to "2", an intermittent sound alarm signals that the locking system is disengaged and, at the same time, the warning light "E" starts flashing again. Warning light "E" turns on to start riding. This means that the system allows for vehicle tilting.

Engaging tilt locking is possible only if the following conditions occur at the same time:

- Throttle completely untwisted
- Engine rpm below 2900rpm
- Vehicle speed below 10 km/h
- Locking system WARNING light "Q" off (the system has not detected failures)

If one of these conditions is not fulfilled, the warning light "E" remains off and locking cannot be engaged (in normal riding conditions, the warning light "E" is off).

With engine on, system locked and warning light "E" on, the suspension locking system is disengaged automatically and the warning light "E" turns off when the throttle is twisted to start the ride.

For riders' safety, the vehicle has a **rider detection sensor** in the saddle which enables the system to prevent vehicle motion and suspension unlocking (in case of locked suspension) when the rider is not properly seated in riding position: in such case, the WARNING light «Q» turns on steadily

CAUTION



THE RIDER DETECTION SENSOR IS LOCATED IN THE FRONT PART OF THE SADDLE. AVOID PLACING BAGS OR HEAVY OBJECTS ACCIDENTALLY ON THE SADDLE.

NOT OBSERVING THIS RULE MAY MOVE THE VEHICLE FORWARD AND RELEASE THE SUSPENSION LOCKING SYSTEM EVEN IF THE RIDER IS NOT SEATED, BY SIMPLY TWISTING THE THROTTLE. THE VEHICLE COULD FALL ACCIDENTALLY AS A CONSEQUENCE.

WARNING

EVERY TIME THE VEHICLE IS STOPPED, MAKE SURE THE FRONT SUSPENSION LOCKING SYSTEM IS ENGAGED. OTHERWISE, PLACE YOUR FEET ON THE GROUND TO KEEP THE VEHICLE UPRIGHT.

WARNING

AVOID USING THE LOCKING SYSTEM WHEN RIDING THE VEHICLE ALONG IRREGULAR ROADS OR ROADS WITH OBSTACLES (E.G. ROAD HUMPS, SIDEWALK, ETC.).

IN CASE OF ENGINE FAILURE (DISCHARGED BATTERY) AVOID PULLING THE VEHICLE WITH THE LOCKING SYSTEM ENGAGED.

WITH THE LOCKING SYSTEM ENGAGED AND THE ENGINE OFF, AVOID MOVING THE VEHICLE AT SPEEDS ABOVE 5 Km/h.

WARNING

IF THE RIDER IS NOT SEATED ON THE SADDLE WHILE THE VEHICLE IS IN MOTION AND THE LOCKING SYSTEM IS ENGAGED, AVOID OPERATING THE THROTTLE CONTROL PURPOSELESSLY AS THIS MAY DAMAGE THE CATALYTIC CONVERTER.

CAUTION

DO NOT RIDE DOWNHILL WITH THE SUSPENSION LOCKING SYSTEM ENGAGED AND THE KEY SWITCH SET TO OFF.

With the vehicle off and the suspension locking system engaged, it is possible to get off the scooter without using the stand. For safety reasons, it is recommended to press the hand brake lever shown in the figure, moving it from "0" to "1".

Warning light "R" on the instrument panel turns on when the hand brake is engaged.

When the hand brake is engaged and the key switch is turned to "1", the safety system that prevents the hand brake from getting released is activated. To release the hand brake, turn the key switch to "2" or "3". If the switch is set to "1", the hand brake can also be engaged.

If the WARNING light "Q" turns on (flashes), it means that there is a failure in the front suspension locking system. Therefore, it is necessary to take your vehicle to a **Piaggio Service Center**. If the front suspension is locked, it can be unlocked by quickly operating the "T" switch twice to the unlocking position "2". Once the suspension is unlocked, the vehicle can be normally used, except for the locking system which will be disengaged.

For some cases of failure, the vehicle speed is auto-limited to 30 Km/h. This automatic procedure is activated to enhance safety until the failure is eliminated.

Always contact a **Piaggio Service Center**

If the continuous sound alarm is activated when the WARNING light "Q" turns on (steadily), try unlocking the system by operating the "T" switch twice to the unlocking position "2". If it cannot be unlocked, take your vehicle to a **Piaggio Service Center** at once.

MP3 125



PIAGGIO®



**Chap. 03
Maintenance**

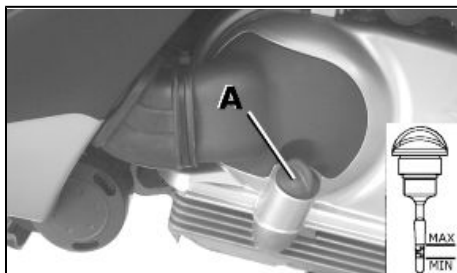

03_01

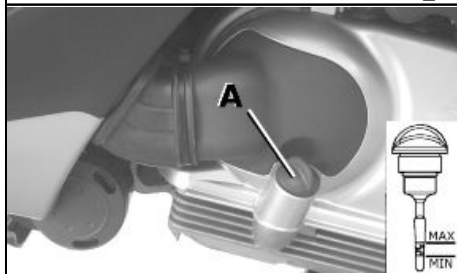

03_02

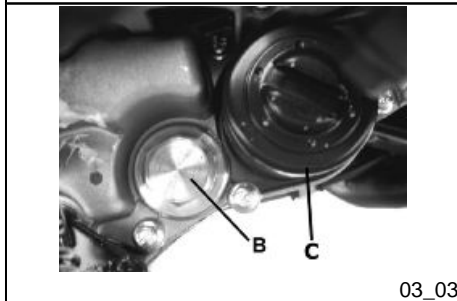

03_03

Engine oil level

In 4T engines, engine oil is used to lubricate the distribution elements, main bearings and thermal group. **An insufficient quantity of oil can cause serious damage to the engine itself.** In all four-stroke engines, a loss of efficiency in oil performance and consumption should be considered normal. Consumption can particularly reflect the conditions of use (i.e. when driving at "full acceleration" all the time, oil consumption increases). The replacement frequencies provided for by the maintenance programme are defined, depending on the total contents of oil in the engine and average consumption measured following standardised methods. **In order to prevent any problems, we recommend checking oil level more frequently than indicated in the Scheduled Maintenance table or before setting off on long journeys. The vehicle is, however, equipped with an oil pressure warning light on the instrument panel.**

Engine oil level check (03_01)

Every time the scooter is used, a visual check should be made on the level of the engine oil when the engine is cold. The oil level should be somewhere between the **MAX** and **MIN** index marks on the level bar; the check must be made with the scooter upright, resting on the centre stand. If the check is carried out after the vehicle has been used, and therefore with a hot engine, the level line will be lower; in order to carry out a correct check it is necessary to wait at least 10 minutes after the engine has been stopped, so as to get the correct level.

Engine oil top-up

Any topping up with oil must be carried out after checking the oil level by adding oil, but **never exceeding the MAX level.** Getting an oil level between the **MIN** and **MAX** marks requires approx. 400 cm³ of oil. Every 3000 km, however, take your scooter to an **Authorised Piaggio Service Centre** to have the engine oil level should be checked and if necessary, topped up.

Warning light (insufficient oil pressure)

The vehicle is equipped with a warning light that lights up when the key is turned to the «ON». However, this light should switch off once the engine has been started. **If the light comes on while braking, at idle speed or while turning a corner, it is necessary to check the oil level and top it up if required. If after having topped-**

up the oil, the warning light still comes on while braking, at idle speed or while turning a corner, it will be necessary to take your vehicle to an Authorised Service Centre.

Engine oil change (03_02, 03_03)

The oil and the cartridge filter «C» must be changed after 1000 km and every 6000 km at an **Authorised Piaggio Service Centre**. The engine should be emptied by draining the oil from the drainage plug «B» of the gauze filter on the flywheel side. In order to facilitate the oil drainage, loosen the cap/dipstick. Since a certain quantity of oil still remains in the circuit, filling must be done with approx 600 ÷ 650 cm³ of oil through the cap «A». Then start up the scooter, leave it running for a few minutes and switch it off: after five minutes, check the level and if necessary top-up **without exceeding the MAX. level**. The cartridge filter must be replaced at every oil change. For top-ups and changes, use new oil of the recommended type.

WARNING



RUNNING THE ENGINE WITH INSUFFICIENT LUBRICATION OR WITH INADEQUATE LUBRICANTS ACCELERATES THE WEAR AND TEAR OF THE MOVING PARTS AND CAN CAUSE IRRETRIEVABLE DAMAGE.

WARNING



EXCESSIVE OIL LEVEL AT TOP-UPS CAN LEAD TO SCALE FORMATION AND VEHICLE MALFUNCTIONING.

CAUTION



USED OILS CONTAIN SUBSTANCES HARMFUL TO THE ENVIRONMENT. FOR OIL REPLACEMENT, CONTACT AN AUTHORISED PIAGGIO SERVICE CENTRE,

AS THEY ARE EQUIPPED TO DISPOSE OF SPENT OILS IN AN ENVIRONMENTALLY FRIENDLY AND LEGAL WAY.

CAUTION



USING OILS OTHER THAN THOSE RECOMMENDED CAN SHORTEN THE LIFE OF THE ENGINE.

Recommended products

AGIP CITY HI TEC 4T

Engine oil

SAE 5W-40, API SL, ACEA A3, JASO MA Synthetic oil

Hub oil level (03_04, 03_05)

Check the oil in the rear hub. (oil content ~ 150 cc). To check the rear hub oil level, proceed as follows:

- 1) Rest the vehicle onto its centre stand, on level ground.
- 2) Unscrew the dipstick «A», dry it with a clean cloth and then reinsert it **screwing it fully into place**.
- 3) Pull out the dipstick to control that the oil level reaches the second notch from the bottom, as indicated by the arrow in figure, this is the correct level and must remain constant at all times.
- 4) Screw the dipstick back in, checking that it is correctly locked in place.

N.B.

The notches on the hub oil level dipstick, except for the one indicating the "MAX" level, refer to other models by the manufacturer and have no specific function for this model.

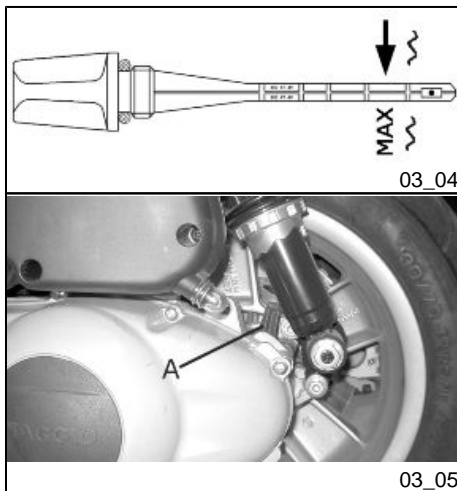

CAUTION

RIDING THE VEHICLE WITH INSUFFICIENT HUB LUBRICATION OR WITH CONTAMINATED OR IMPROPER LUBRICANTS ACCELERATES THE WEAR AND TEAR OF THE MOVING PARTS AND CAN CAUSE SERIOUS DAMAGE.

CAUTION

USED OIL CAN HARM THE ENVIRONMENT. COLLECTION AND DISPOSAL SHOULD BE CARRIED OUT IN COMPLIANCE WITH CURRENT REGULATIONS.

CAUTION

AN EXCESSIVE QUANTITY OF OIL CAN LEAD TO LEAKAGE, WHICH MAY CAUSE THE ENGINE AND THE WHEEL TO GET DIRTY.

CAUTION

WHEN REPLACING THE HUB OIL DO NOT LET THE OIL COME INTO CONTACT WITH THE REAR BRAKE DISC.

CAUTION

FOR OIL REPLACEMENT, CONTACT ANY AUTHORISED SERVICE CENTRE AS THEY ARE EQUIPPED TO DISPOSE OF USED OILS IN AN ENVIRONMENTALLY FRIENDLY AND LEGAL WAY.

Recommended products

AGIP ROTRA 80W-90

Rear hub oil

SAE 80W/90 Oil that exceeds the requirements of API GL3 specifications

Characteristic

Rear hub oil

Capacity ~ 150 cm³



Tyres (03_06)

WARNING



THE WHEELS FITTED WITH TYRES SHOULD ALWAYS BE BALANCED. RIDING THE VEHICLE WITH VERY LOW TYRE PRESSURE OR WITH INCORRECTLY BALANCED TYRES CAN LEAD TO DANGEROUS STEERING VIBRATIONS.

Characteristic

Front tyre pressure (rider)

Front tyre pressure (rider): 1.6 bar

Front tyre pressure (rider and passenger)

Front tyre pressure (rider and passenger): 1.8 bar

Rear tyre pressure (rider)

Rear tyre pressure (rider): 2 bar

Rear wheel pressure (rider and passenger):

Rear tyre pressure (rider and passenger): 2.4 bar

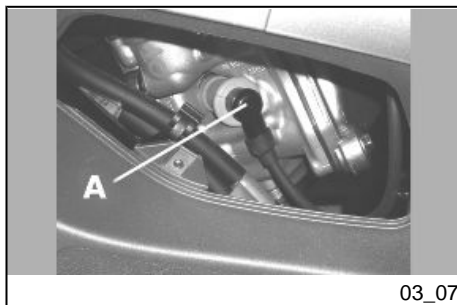

03_07

Spark plug dismantlement (03_07)

Remove the port on the right-hand side panel of the scooter by undoing the clamping screw and using a small screwdriver in the rear recess shown in the figure, then do the following :

1. Disconnect spark plug HV wire cap "A";
2. Unscrew the spark plug using the wrench supplied. ;
3. When refitting, place the spark plug in the hole at the due inclination and tighten it by hand until it is finger tight;
4. Only use the wrench to lock it in place;
5. Place hood "A" fully over the spark plug.
6. Refit the port making sure the rear hook is inserted.

CAUTION



THE SPARK PLUG MUST BE REMOVED WHEN THE ENGINE IS COLD. THE SPARK PLUG SHOULD BE CHECKED EVERY 6,000 KM AND REPLACED EVERY 12,000 KM. THE USE OF NON-CONFORMING IGNITION CONTROL UNITS AND SPARK PLUGS OTHER THAN THOSE PRESCRIBED CAN SERIOUSLY DAMAGE THE ENGINE

N.B.

THE USE OF SPARK PLUGS OTHER THAN THE INDICATED TYPE OR OF SHIELDLESS SPARK PLUG CAPS CAN CAUSE ELECTRICAL SYSTEM FAILURES.

Electric characteristic

Candela

CHAMPION RG4HC

NGK CR8EB

Electrode gap

0.7 ÷ 0.8 mm

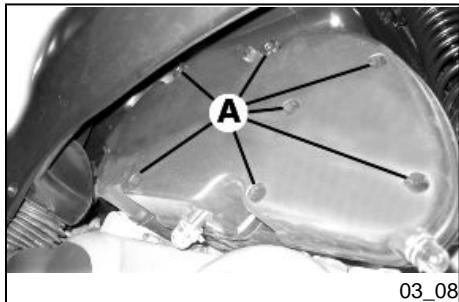

Removing the air filter (03_08)

Proceed as follows:

Undo the clamping screws «A» (two of which are on the knob-type head) and remove the air-box cover.

Air filter cleaning

1. Wash the sponge with water and neutral soap.
2. Dry it with a clean cloth and small blasts of compressed air.
3. Impregnate the sponge with a mixture of 50% petrol and 50% specified oil.
4. Gently squeeze the filter element, let it drip and then refit it.

CAUTION



IF THE VEHICLE IS USED ON DUSTY ROADS IT IS NECESSARY TO CARRY OUT MAINTENANCE CONTROLS OF THE AIR FILTER TO AVOID DAMAGING THE ENGINE.

Recommended products

AGIP FILTER OIL

Oil for air filter sponge

Mineral oil with specific additives for increased adhesiveness

Secondary air system (03_09)

In order to reduce polluting emissions, the vehicle is furnished with a catalytic converter in the muffler.

To improve the catalytic converter functioning, a further quantity of oxygen is brought in through the secondary air system (SAS).

This system allows more oxygen to be added to the unburned gas before it reaches the converter, thus improving the action of the catalytic converter.

Air flows in through the discharge pipe on the head, after being cleaned by the filter «**B**».

The system has a control valve that disables operation during deceleration in order to avoid abnormal noises.

To ensure the best functioning of the SAS system, every two years the scooter should be taken to an **Authorised Piaggio Service Centre** to have the filters cleaned (Scheduled maintenance section).

The filter sponge should be cleaned with water and mild soap, then it should be dried with a cloth and slight blows of compressed air.

Cooling fluid level (03_10, 03_11, 03_12, 03_13)

The engine cooling system operates by forcing circulation of fluid. The cooling circuit contains about 2 litres of coolant consisting of a mixture of 50% de-ionised water and glycol ethylene-based antifreeze solution with corrosion inhibitors. Recommended coolant, supplied with already mixed and ready for use fluid. For proper functioning of the engine, the coolant temperature must be between the 4th and 7th lit segment, as indicated by the instrument «**D**» on the digital instrument panel. When the 9th lights up, the icon and all the segments start flashing; stop the engine, let it cool down and check the fluid level; if the result is normal, take your vehicle to an **Authorised Piaggio Service Centre**.

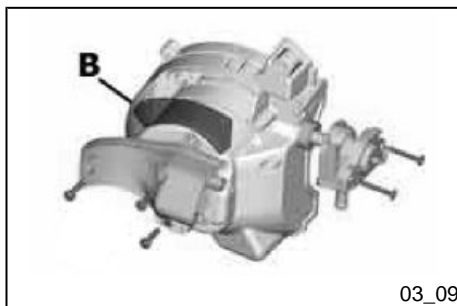

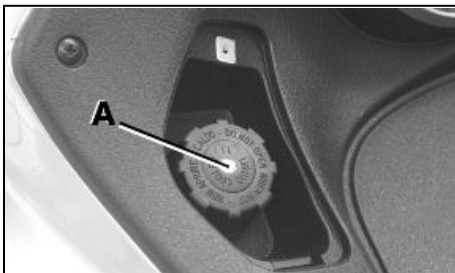

03_11

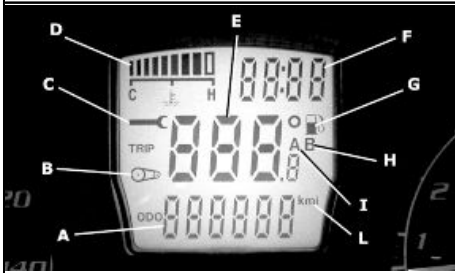

03_12

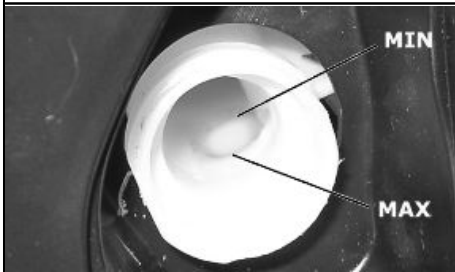

03_13

The fluid inspection should be carried out every 6,000 km when the engine is cold, following the methods indicated below.

- Rest the vehicle in vertical position on the stand and remove the screw of the expansion tank cap shown in the photo
- Remove the expansion tank cover "A", turning in anticlockwise direction.
- Look inside the expansion tank; the fluid level must always be between the min and the max level
- If the coolant level is near the minimum mark, top up when the engine is cold.

If it is necessary to top up the coolant frequently, or if the expansion tank is completely dry, you should look for the cause in the cooling system. It is therefore indispensable to have the cooling system checked at an **Authorised Piaggio Service Centre**. The coolant should be replaced every 2 years. Take your vehicle to an **Authorised Piaggio Service Centre** for this operation.

N.B.

SHOULD THE 9th SEGMENT OF THE COOLANT TEMPERATURE INDICATOR COME ON DURING A NON-DEMANDING RIDE, SHUT OFF THE ENGINE AND LET IT COOL DOWN. THEN CHECK THE COOLANT LEVEL; IF THE LEVEL IS OK, CONTACT AN AUTHORISED SERVICE CENTRE.

WARNING



IN ORDER TO AVOID BURNS, DO NOT UNSCREW THE EXPANSION TANK CAP WHILE THE ENGINE IS STILL HOT.

WARNING



IN ORDER TO AVOID HARMFUL FLUID LEAKS WHILE RIDING, IT IS IMPORTANT TO MAKE SURE THAT THE LEVEL NEVER EXCEEDS THE MAXIMUM VALUE.

IN ORDER TO GUARANTEE THE PROPER FUNCTION OF THE ENGINE, IT IS NECESSARY TO KEEP THE RADIATOR GRILLE CLEAN.

Recommended products

SPECIAL AGIP PERMANENT fluid

coolant

Monoethylene glycol-based antifreeze fluid, CUNA NC 956-16

Checking the brake oil level (03_14)

The front and rear brake fluid reservoirs are both positioned on the handlebars. Proceed as follows:

1. Place the scooter on its centre stand and make sure the handlebar is centred;
2. Check the fluid through the specific sight glass «C».

A certain lowering of the level is caused by wear on the pads. Should the level appear to be below the minimum mark, please contact an **Authorised Service Centre or Dealer** in order to have braking system thoroughly checked.

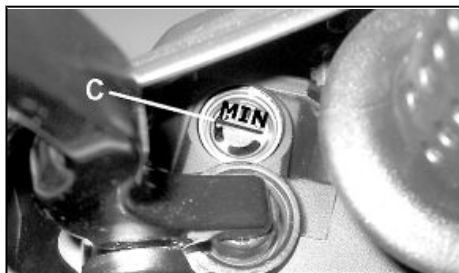

03_14

Braking system fluid top up (03_15)

Proceed as follows:

Loosen the fixing screws "B" and lift the plastic cover "A" in order to access the brake reservoir. Loosen the two fixing screws and remove the reservoir cover; top-up with the recommended fluid without exceeding the 'MAX.' mark.

This procedure applies to the rear brake pump top-up operation; follow the same procedure for the front brake pump.

Under normal climatic conditions, the brake fluid should be replaced every 2 years.

This operation must be carried out by trained technicians; please contact your nearest **PIAGGIO dealer or an authorised service centre.**



03_15

WARNING

ONLY USE DOT 4 CLASS BRAKE FLUIDS. COOLING SYSTEM FLUIDS ARE HIGHLY CORROSIVE. MAKE SURE THAT IT DOES NOT COME INTO CONTACT WITH THE PAINTWORK

CAUTION

AVOID CONTACT OF BRAKE FLUID WITH EYES, SKIN, AND CLOTHING. IN CASE OF CONTACT, RINSE WITH WATER. THE BRAKING CIRCUIT FLUID IS HYGROSCOPIC, THAT IS, IT ABSORBS HUMIDITY FROM THE SURROUNDING AIR. IF THE HUMIDITY IN THE BRAKING FLUID EXCEEDS A CERTAIN VALUE, IT WILL LEAD TO INEFFICIENT BRAKING. NEVER USE BRAKING FLUID KEPT IN CONTAINERS THAT HAVE ALREADY BEEN OPENED, OR PARTIALLY USED.

Recommended products**AGIP BRAKE 4**

Brake fluid

FMVSS DOT 4 Synthetic fluid

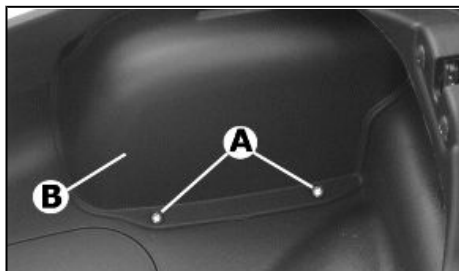

03_16

Battery (03_16)

To access the battery, proceed as follows:

1. Place the scooter on its centre stand;
2. Open the saddle, following the previously described procedure;
3. Remove the two fasteners "A" and the cover "B".

WARNING



IN ORDER TO AVOID DAMAGING THE ELECTRICAL SYSTEM, NEVER DISCONNECT THE WIRING WHILE THE ENGINE IS RUNNING.

Use of a new battery

Make sure that the terminals are connected correctly.

CAUTION



DO NOT REVERSE THE POLARITY: RISK OF SHORT CIRCUIT AND DAMAGE TO THE ELECTRICAL SYSTEM.

WARNING



SPENT BATTERIES ARE HARMFUL FOR THE ENVIRONMENT. COLLECTION AND DISPOSAL SHOULD BE CARRIED OUT IN COMPLIANCE WITH CURRENT REGULATIONS.

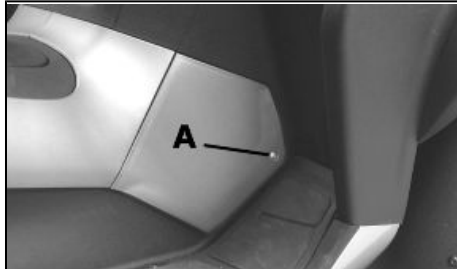

03_17



03_18

Long periods of inactivity

If the vehicle has not been used for long periods, it is necessary to periodically recharge the battery, bearing in mind that the battery tends to go completely flat within around three months. The battery must be recharged with a current load equal to 1/10 of the battery rated capacity (~ 1A), for a period not longer than 8 hours. For this operation contact an **Authorised Service Centre**. When refitting a removed battery, make sure that all terminals are properly connected.

Fuses (03_17, 03_18, 03_19)

The electrical system has eight fuses divided into two fuse boxes to protect the different installation circuits. One of them is inside the battery compartment and the other is at the right internal side of the footrest. To be able to reach them, loosen the screw "A" and remove the plastic cover. The table shows the fuses position and specifications in the vehicle.

CAUTION



BEFORE REPLACING THE BLOWN FUSE, FIND AND SOLVE THE FAILURE THAT CAUSED IT TO BLOW. NEVER TRY TO REPLACE THE FUSE WITH ANY OTHER MATERIAL (E.G., A PIECE OF ELECTRIC WIRE).

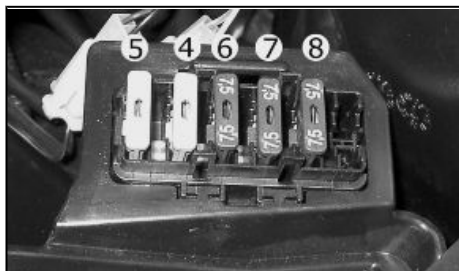

03_19

FUSE TABLE

Fuse No. 1

Capacity: 20A

Protected circuits: (for vehicles with rear suspension control)

battery-powered: saddle opening receiver, case lighting, headlight, antitheft device, instrument panel, hazard.

live: fuses 6-7-8, instrument panel control unit.

(for vehicles with front suspension control)

battery-powered: saddle opening receiver, case lighting, headlight, antitheft device, instrument panel, hazard.

live: fuses 5-6-7.

Location: battery compartment

Fuse No. 2

Capacity: 20A

Protected circuits: (for vehicles with rear suspension control)

battery-powered: voltage regulator, electrical fan, electronic ignition.

live: Run/Off, starter, TPS, electronic ignition, fuel pump if available, fuse 5.

Capacity: 15A**Protected circuits: (for vehicles with front suspension control)**

battery-powered: voltage regulator, electrical fan, electronic ignition, TPS.

live: starter, electronic ignition, fuel pump if available, fuses 4-8.

Location: battery compartment

Fuse No. 3

Capacity: 20A

Protected circuits: (for vehicles with rear suspension control)

battery-powered: parking control ECU

Capacity: 15 A

Protected circuits: (for vehicles without front suspension control) battery-powered: light relay.

Location: battery compartment

Fuse No. 4

Capacity: 4A

Protected circuits:ignition, lights, stop.

Location:footrest

Fuse No. 5

Capacity: 4A

Protected circuits:tail lights, license plate light, panel lighting.

Location:footrest

Fuse No. 6

Capacity: 7.5 A

Protected circuits:Passing, horn.

Location:footrest

Fuse No. 7

Capacity: 7.5 A

Protected circuits:saddle opening receiver, hazard, antitheft device, instrument panel.

Location:footrest

Fuse No. 8

Capacity: 7.5 A

Protected circuits: (for vehicles with front suspension control) headlight remote control

Capacity: 4A

Protected circuits: (for vehicles without front suspension control) headlight remote control

Location:footrest

LIGHT BULBS TABLE

Low-beam bulb	Type: HALOGEN (H1) Power: 12V - 55W Quantity: 1
High-beam light bulb	Type: HALOGEN (H1) Power: 12V - 55W Quantity: 1
Helmet compartment light bulb	Type: CYLINDRIC Power: 12V - 5W Quantity: 1
Rear turn indicator bulb	Type: ALL GLASS Power: 12V - 5W Quantity: 2 RHS + 2 LHS
Rear tail light bulb	Type: ALL GLASS Power: 12V - 5W Quantity: 1 RHS + 1 LHS
Stop light bulb	Type: SPHERICAL Power: 12V - 10W Quantity: 2
License plate light bulb	Type: ALL GLASS

Power: 12V - 5W**Quantity:** 1

Front turn indicator bulb

Type: ALL GLASS**Power:** 12V - 10W**Quantity:** 1 RHS + 1 LHS

Front tail light bulb

Type: ALL GLASS**Power:** 12V - 3W**Quantity:** 1 RHS + 1 LHS

Instrument panel bulb

Type: ALL GLASS**Power:** 12V - 2W**Quantity:** 4

Front light group (03_20, 03_21, 03_22, 03_23, 03_24, 03_25, 03_26, 03_27, 03_28)

To remove the front headlight assembly, proceed as follows:

1. Remove the Piaggio clip-on badge
2. Remove the screw «A» and the headlight assembly central cover
3. Remove the two headlamp upper fixing screws «B»
4. Remove the two grille front fixing screws «C»
5. Remove the two screws «D» located under the grille
6. Remove the two screws «E» located inside the front shield
7. Remove the grille
8. Remove the two headlight lower fixing screws «F»
9. Take out the front headlight assembly

Refit the components following the above operations in reversed order

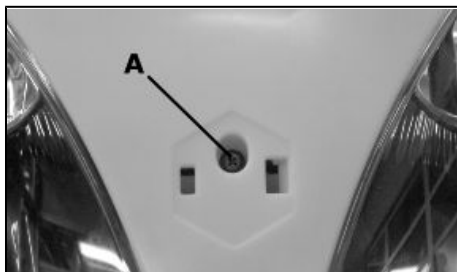

03_21

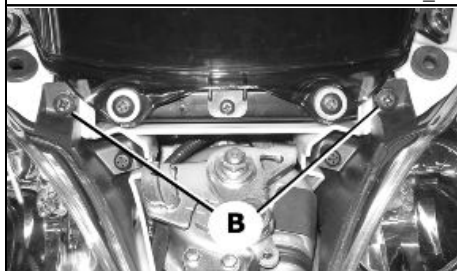

03_22



03_23

WARNING

HIGH AND LOW BEAM LIGHT ARE OF THE HALOGEN TYPE: DO NOT TOUCH WITH YOUR FINGERS TO AVOID DAMAGING THEIR FUNCTION.

Headlight adjustment (03_29, 03_30)

Proceed as follows:

1. Position the unloaded vehicle, in running order and with the tyres inflated to the prescribed pressure, on a flat surface 10 m away from a half-lit white screen; ensure that the longitudinal axis of the vehicle is perpendicular to the screen;
2. Remove the headlight assembly central cover
3. Turn on the headlight and check that the limit of the projected light beam is not over 9/10 or below 7/10 of the distance from the ground to the centre of the vehicle headlight;
4. Otherwise, adjust the headlight with the screws «A» indicated in the figure

N.B.

THE ABOVE PROCEDURE COMPLIES WITH THE EUROPEAN STANDARDS REGARDING MAXIMUM AND MINIMUM HEIGHT OF LIGHT BEAMS. REFER TO THE STATUTORY REGULATIONS IN FORCE IN EVERY COUNTRY WHERE THE vehicle IS USED.



03_24

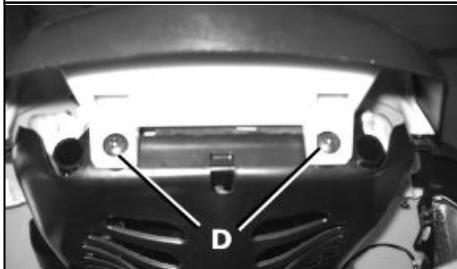

03_25

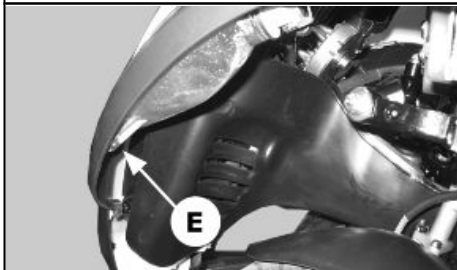

03_26

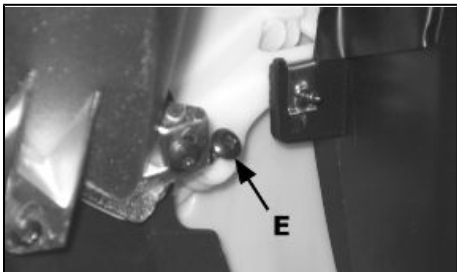

03_27

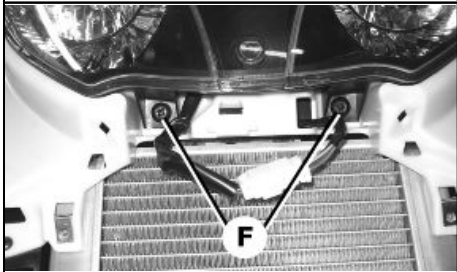

03_28

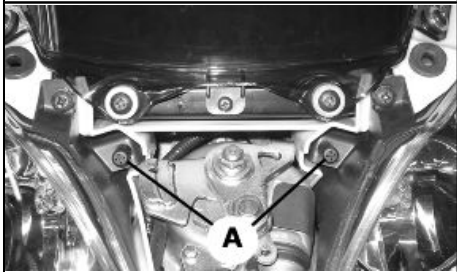

03_29

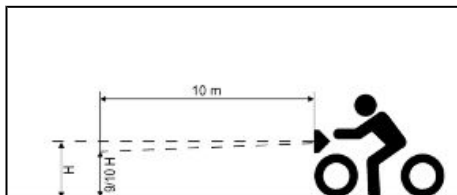

03_30

Front direction indicators (03_31, 03_32)

To remove the front turn indicator bulb, turn the bulb holder «A» anticlockwise and remove it from its fitting.

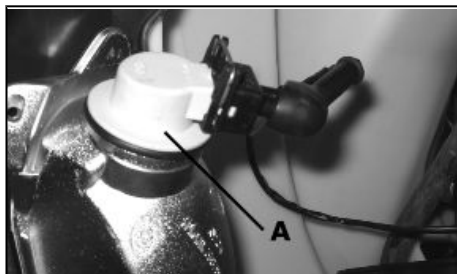

03_31



03_32

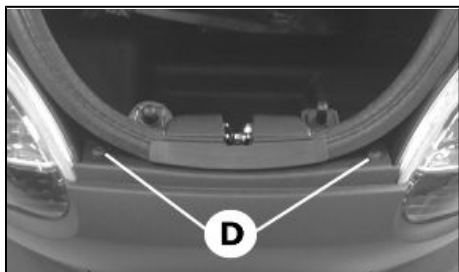

03_33

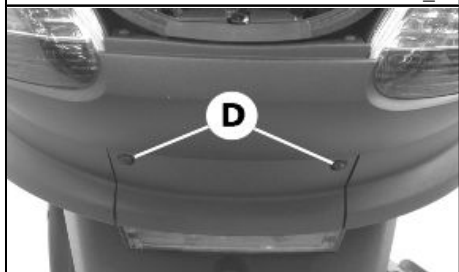

03_34



03_35

Rear optical unit (03_33, 03_34, 03_35, 03_36)

Open the rear case cover, remove the two screws «D», and then, the other four fixing screws «D» to pull out the headlight assembly from its fitting.

Follow this procedure to remove the bulbs:

Remove the snap-on bulbs «B».

Remove the bulbs «A» on the bayonet by turning them 30° clockwise.

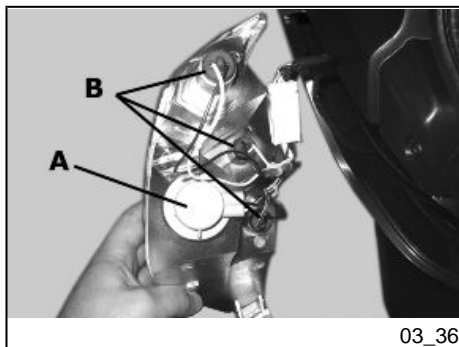

Number plate light (03_37, 03_38)

Open the rear case and remove the rubber «A» shown in the figure without damaging the plastic parts. Next, slide off the bulb holder.

Remove the bulb afterwards.





03_39

Helmet compartment lighting bulb (03_39)

Open the rear boot and insert a small plain slot screwdriver in the lateral notch to detach the snap-on glass "D", then replace the bulb.



03_40

Rear-view mirrors (03_40)

The mirrors can be set to the desired position by adjusting the mirror frame.

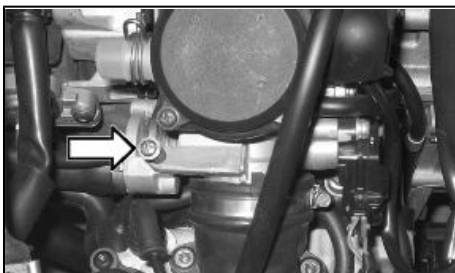

03_41

Idle adjustment (03_41)

Proceed as follows:

1. Rest the scooter on its centre stand and lift the saddle.
2. Remove the access door to the carburettor.
3. To adjust the idle speed, start the engine, then loosen or tighten the screw indicated in the figure until you reach the recommended idle speed taking care the engine does not make the rear wheel move.

If it is difficult to adjust the idle speed, take your vehicle to an **Authorised PIAGGIO Service Centre or Dealer**.

IDLE SPEED MUST BE ADJUSTED WHEN THE ENGINE IS VERY HOT. BEFORE THIS OPERATION, MAKE SURE THAT THE THROTTLE GRIP HAS THE RECOMMENDED BACKLASH. IF BACKLASH IN THE THROTTLE CONTROL TRANSMISSION NEEDS ADJUSTING TAKE YOUR SCOOTER TO AN AUTHORISED PIAGGIO DEALER OR SERVICE CENTRE Specifications

Idle speed adjustment

about 1650±50 rpm

Front and rear disc brake

The brake disc and pad wear is automatically compensated, therefore it has no effect on the functioning of the front and rear brakes. For this reason it is not necessary to adjust the brakes. An excessively elastic brake lever stroke may indicate the presence of air in the braking circuit or a failure in the braking system. In this case, mainly due to the importance of brakes to guarantee safe riding conditions, the vehicle should be taken to an **Authorised Service Centre or Dealer**.

CAUTION



THE BRAKING ACTION SHOULD BEGIN AFTER ABOUT 1/3 OF THE BRAKE LEVER STROKE.

CAUTION



HAVE THE BRAKE PADS CHECKED BY THE DEALER ACCORDING TO THE CHECKS SPECIFIED IN THE SCHEDULED MAINTENANCE TABLE. HOWEVER, IN THE EVENT OF NOISES COMING FROM THE FRONT AND/OR REAR BRAKE SYSTEM DURING OPERATION, IT IS ADVISABLE TO HAVE THE BRAKE SYSTEM CHECKED BY A PIAGGIO DEALER OR AUTHORISED SERVICE CENTRE. AFTER REPLACING THE BRAKE PADS, DO NOT USE THE SCOOTER UNTIL YOU HAVE OPERATED THE BRAKE LEVER SEVERAL TIMES IN ORDER TO

ALLOW THE PLUNGERS TO SETTLE AND THE LEVER STROKE TO BE SET TO THE CORRECT POSITION.

CAUTION



THE PRESENCE OF SAND, MUD, SNOW MIXED WITH SALT, ETC. ON THE ROAD, CAN DRASTICALLY REDUCE THE DURATION OF THE BRAKE PADS. IN ORDER TO AVOID THIS, WE RECOMMEND WASHING THE VEHICLE FREQUENTLY WHEN RIDING IN THESE ROAD CONDITIONS.

Puncture

The vehicle is equipped with tubeless tyres (without inner tube). In the event of a puncture, contrary to the situation with a tyre with inner tube, the tyre deflates more slowly, resulting in a greater steering safety. In the event of a puncture, it is admissible to make an emergency repair using an "inflate and repair" spray can. For a final repair, take your vehicle to an **Authorised Service Centre or Dealer**. The replacement of a tyre involves removing the wheel in question. Take your vehicle to an **Authorised Service Centre or Dealer** for these operations.

CAUTION



TO USE THE "INFLATE AND REPAIR" SPRAY PROPERLY FOLLOW THE INSTRUCTIONS ON THE PACKAGING.

WARNING

THE WHEELS FITTED WITH TYRES SHOULD ALWAYS BE BALANCED. RIDING THE VEHICLE WITH VERY LOW TYRE PRESSURE OR WITH INCORRECTLY BALANCED TYRES CAN LEAD TO DANGEROUS STEERING VIBRATIONS.

Periods of inactivity

We recommend carrying out the following operations:

1. Clean the scooter thoroughly and then cover it with a canvas;
2. Be careful to rest the vehicle on its centre stand disabling the front suspension locking system;
3. With engine off and piston at the bottom dead centre, remove the spark plug, add 1÷2 cc of oil through the opening (adding more oil may damage the engine). Operate the starter button 1-2 times for roughly 1 second to turn the engine over slowly, then insert the spark plug again;
4. Empty all fuel; spread antirust grease on the unpainted metal parts; keep the wheels lifted above the ground by resting the chassis on two wooden wedges;
5. For the battery, follow the procedures described in the «Battery» section.

Recommended products**AGIP CITY HI TEC 4T**

Oil to lubricate flexible transmissions (throttle control)

Oil for 4-stroke engines

Cleaning the vehicle

In order to soften the dirt and mud deposited on the painted surfaces, use a low pressure jet of water. Once softened, mud and dirt must be removed with a soft sponge for bodywork soaked in lots of water and "shampoo" (2-4% of car shampoo in water).

Then rinse abundantly with water, and dry with a shammy cloth. For the outside of the engine, use petroleum, a brush and clean cloths. Petroleum can damage paintwork. Remember that any polishing with silicone wax must always be preceded by washing

CAUTION



DETERGENTS CAN POLLUTE WATER. THE VEHICLE MUST BE WASHED AT A WASH STATION EQUIPPED WITH A SPECIAL WATER PURIFICATION SYSTEM.

CAUTION



PER IL LAVAGGIO DEL MOTORE E DEL VEICOLO È SCONSIGLIATO L'UTILIZZO DELL'IDROPULTRICE; NEL CASO CHE NON SIA POSSIBILE EFFETTUARE TALE OPERAZIONE IN UN ALTRO MODO, È NECESSARIO:

- **USARE SOLAMENTE IL GETTO A VENTAGLIO.**
- **NON AVVICINARE LA LANCIA A MENO DI 2 FT (60 CM).**
- **NON USARE ACQUA A TEMPERATURE SUPERIORI A 100° F (40°C).**
- **NON UTILIZZARE IL GETTO AD ALTA PRESSIONE.**
- **NON UTILIZZARE IL LAVAGGIO A VAPORE.**
- **NON INDIRIZZARE IL GETTO DIRETTAMENTE VERSO: IL MOTORE, I CABLAGGI ELETTRICI, LE FERITOIE DI RAFFREDDAMENTO DEL COPERCHIO TRASMISSIONE E DEL COPERCHIO CHIOCCIOLA.**

CAUTION



NEVER WASH THE SCOOTER IN DIRECT SUNLIGHT, ESPECIALLY IN SUMMER WHEN THE BODYWORK IS STILL HOT AS THE SHAMPOO COULD DAMAGE THE PAINTWORK IF IT DRIES BEFORE BEING RINSED OFF. NEVER USE

CLOTHS SOAKED IN ALCOHOL, PETROL, DIESEL OIL OR KEROSENE FOR CLEANING THE PAINTED OR PLASTIC SURFACES, IN ORDER NOT TO DAMAGE THE LUSTRE FINISH OR ALTER THE MECHANICAL PROPERTIES. USING SILICONE-BASED WAX CAN DAMAGE THE PAINTED SURFACES, DEPENDING ON THE VEHICLE COLOUR (SATIN COLOURS). FOR FURTHER INFORMATION ON THIS MATTER, CONTACT AN AUTHORISED SERVICE CENTRE .

STARTING FAILURE

Emergency switch in «OFF»	Set the switch back to «ON»
Fuse blown	Replace the blown fuse and have the vehicle checked by an Authorised Service Centre.

IGNITION PROBLEM

Faulty spark plug	Contact an Authorised Service Centre.
Faulty ignition / injection control unit.	Contact an Authorised Service Centre.
Faulty coil. Due to the presence of high voltage, this check should only be carried out by an expert.	Contact an Authorised Service Centre.

LACK OF COMPRESSION

Loosen spark plug.	Screw in the spark plug tightly
--------------------	---------------------------------

Cylinder head loose, piston gas rings worn.	Contact an Authorised Service Centre.
---	--

Valve stuck	Contact an Authorised Service Centre.
-------------	--

HIGH CONSUMPTION AND LOW PERFORMANCE

Air filter blocked or dirty.	Clean with water and shampoo and impregnate with petrol and specific oil (section «Removing the air filter»)
------------------------------	--

INSUFFICIENT BRAKING

Greasy disc. Worn pads. Faulty braking system. Presence of air in the front and rear brake circuit.	Contact an Authorised Service Centre.
---	--

INEFFICIENT SUSPENSIONS

Shock absorber fault, oil leak, end buffer damaged; shock absorber preloading incorrectly set	Contact an Authorised Service Centre.
---	--

IRREGULAR AUTOMATIC TRANSMISSION

Variator rollers and/or driving belt damaged	Contact an Authorised Service Centre.
--	--

STAND DOES NOT RETURN TO POSITION

Presence of dirt

Clean and grease

MP3 125



PIAGGIO®



Chap. 04
Technical data

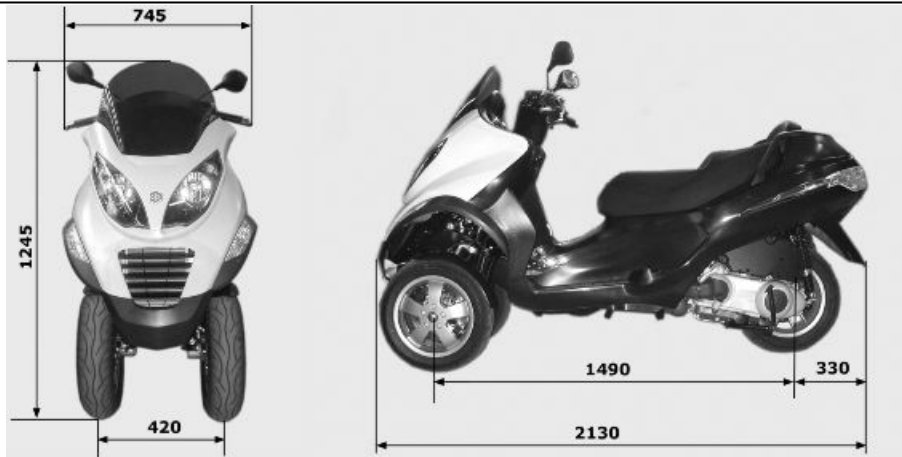

04_01

TECHNICAL DATA FOR MP3 125 EURO3

Electronic ignition	capacitive, with variable timing and separate HV coil
Fuel supply	Unleaded petrol; depression carburettor, electric pump or vacuum pump.
Transmission	With automatic expandable pulley variator with torque server, V belt, self-ventilating automatic centrifugal dry clutch, gear reduction unit and transmission housing with forced air circulation cooling.

Lubrication	Engine lubrication with lobe pump (inside crankcase) controlled by a chain with double filter: mesh and paper.
Cooling	Forced fluid circulation, with engine driven pump; 3-way thermostat to pump intake.
Exhaust muffler	absorption-type exhaust muffler with catalytic converter.
Front suspension	The tilt mechanism is composed of an articulated parallelogram suspension with die-cast aluminium control arms and two side headstocks plus shock absorbers with hydraulic locking system.
Rear suspension	Single arm with two double-acting hydraulic shock absorbers and preloading adjustable to 4 positions.
Front wheel	Alloy rims: 12" x 3.00"
Rear wheel	Alloy rim: 12"x 3.50"
Front tyre	Without inner tube 120/70-12" 51P
Rear tyre	Without inner tube: 130/70-12" 62P
Front brake	Ø 240 mm double disk with hydraulic control activated by the handlebar right-hand lever.
Rear brake	Ø 240 mm disc brake with hydraulic control activated by the handlebar left-side lever.
Chassis	Tubular and sheet steel.

dry weight	219 ± 5 kg
bearing	410 kg
Max. speed	100 km/h
Air filter	Sponge impregnated with fuel mixture (50% SELENIA air filter oil and 50% unleaded petrol).
Fuel tank capacity	Tank capacity: ~12 l (approximate value)
Fuel reserve	~ 2.0 l (approximate value)
Cooling circuit	Capacity: ~ 2.0 l
Rear oil hub	Capacity: ~150 cc

125 EURO3 ENGINE SPECIFICATIONS

Version	125 EURO3
Engine	single-cylinder, four-stroke
Bore x stroke	57 x 48.6 mm
Cubic capacity	124 cm ³
Compression ratio	11.5 - 12.5 : 1
Ignition/advance	Electronic, with inductive discharge and variable advance with three-dimensional mapping
Carburettor Keihin	CVEK-30
Spark plug	NGK CR 8EB
Spark plug	Champion RG 4 HC

valve clearance

intake: 0.10 mm - discharge: 0.15
mm

** The identification letter can vary with each carburettor update*

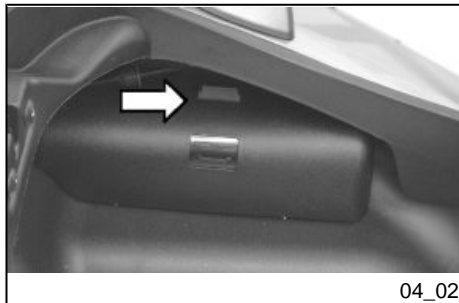

Kit equipment (04_02)

One box-spanner; one lever for box-spanner; one twin screwdriver; one flat wrench 13 mm; one special spanner for adjusting the rear shock absorbers one plastic gripper for removing the fuses.

The tools are stored under the saddle in the compartment provided. To open it, release the catch shown in the figure.

MP3 125



PIAGGIO®



Chap. 05
Spare parts and
accessories



05_01

Warnings (05_01)

WARNING



TO PREVENT ACCIDENTS AND TO GUARANTEE PROPER STABILITY, PERFORMANCE AND SAFETY, RIDE THE VEHICLE VERY CAREFULLY WHEN IT IS FITTED WITH ACCESSORIES OR WITH UNUSUAL LOADS.

WARNING



IT IS ALSO RECOMMENDED THAT "ORIGINAL PIAGGIO SPARE PARTS" BE USED, AS THESE ARE THE ONLY ONES OFFERING YOU THE SAME QUALITY GUARANTEE AS THOSE INITIALLY FITTED ON THE SCOOTER. THE USE OF NON-ORIGINAL SPARE PARTS RENDERS THE WARRANTY VOID.

WARNING

PIAGGIO MARKETS ITS OWN LINE OF ACCESSORIES THAT ARE RECOGNISED AND GUARANTEED FOR USE. IT IS THEREFORE ESSENTIAL, IN ORDER TO CHOOSE AND MOUNT THE ACCESSORIES CORRECTLY, TO CONTACT AN AUTHORISED DEALER OR SERVICE CENTRE. THE USE OF NON-ORIGINAL ACCESSORIES MAY AFFECT THE STABILITY AND OPERATION OF YOUR VEHICLE AND REDUCE SAFETY LEVELS WITH POTENTIAL RISKS FOR THE RIDER.

WARNING

NEVER RIDE THE SCOOTER EQUIPPED WITH ACCESSORIES (TOP BOX AND/OR WINDSHIELD) AT A SPEED HIGHER THAN 100 km/h.

THE SCOOTER CAN BE RIDDEN AT A HIGHER SPEED WITHOUT THE ACCESSORIES MENTIONED BEFORE WITHIN THE LIMITS ESTABLISHED BY LAW.

IF THERE SHOULD BE NOT-PIAGGIO ACCESSORIES INSTALLED, OR AN ABNORMAL LOAD, OR IF THE SCOOTER IS NOT IN A GENERALLY GOOD CONDITION, OR WHENEVER WEATHER CONDITIONS DEMAND IT, SPEED SHOULD BE REDUCED FURTHER.

WARNING

BE EXTREMELY CAREFUL WHEN INSTALLING AND REMOVING THE MECHANICAL ANTITHEFT DEVICE ON THE VEHICLE (U-SHAPED PADLOCK, DISC BLOCK, ETC.).

MAINLY DUE TO THE PROXIMITY TO THE BRAKE PIPES, TRANSMISSIONS AND/OR ELECTRIC CABLES, AN INCORRECT INSTALLATION OR REMOVAL OF THE ANTITHEFT DEVICE AS WELL AS LEAVING IT ON BEFORE STARTING THE VEHI-

CLE CAN SERIOUSLY DAMAGE ITS COMPONENTS AND AFFECT THE CORRECT FUNCTIONING OF THE VEHICLE AND HARM THE USER.

MP3 125



PIAGGIO®



**Chap. 06
Programmed
maintenance**

Scheduled maintenance table

Adequate maintenance is fundamental to ensuring long-lasting, optimum operation and performance of your vehicle.

To this end, a series of checks and maintenance operations (at the owner's expense) have been suggested, which are included in the summary table on the following page. Any minor faults should be reported without delay to an **Authorised Service Centre or Dealer** without waiting until the next scheduled service to solve it.

All scheduled maintenance services must be carried out at the specified times, even if the stated mileage has not yet been reached. Carrying out scheduled services on time is necessary to ensure your warranty remains valid. For any further information concerning Warranty procedures and "Scheduled Maintenance", please refer to the "Warranty Booklet".

EVERY 2 YEARS

Coolant - change

Brake fluid - change

secondary air filter - cleaning

EVERY 3.000 KM

Engine oil - level check/ top-up

AFTER 1,000 KM

Engine oil - replacement

Hub oil - change

Engine oil - change

Idle speed (*) - adjustment

Throttle lever - adjustment

Steering - adjustment

Brake control levers - greasing

Brake pads - check condition and wear

Brake fluid level - check

Tilt locking gripper control cable - adjustment

Safety locks - check

Electrical system and battery - check

Tyre pressure and wear - check

Vehicle and brake test - road test

(*) See instructions in «Idle speed adjustment» section

AFTER 6.000 KM

Hub oil level - check

Spark plug/ electrode gap - check

Air filter - clean

Sliding blocks / variable speed rollers - check

Driving belt - check

Coolant level - check

Brake pads - check condition and wear

Brake fluid level - check

Tilt locking gripper control cable - adjustment

Electrical system and battery - check

Tyre pressure and wear - check

Vehicle and brake test - road test

Engine oil - change

Oil filter -Replacement

Valve clearance - check

AFTER 12,000 KM AND AFTER 60,000 KM

Engine oil - replacement

Hub oil level - check

Spark plug / electrode gap - check / replacement

Air filter - clean

Engine oil - change

Idle speed (*) - adjustment

Sliding block / variable speed rollers - change

Throttle lever - adjustment

Coolant level - check

Steering - adjustment

Brake control levers - greasing

Brake pads - check condition and wear

Brake fluid level - check

Tilt locking gripper control cable - adjustment

Transmission elements - lubrication

Safety locks - check

Suspensions - check

Electrical system and battery - check

Headlight - adjustment

Tyre pressure and wear - check

Vehicle and brake test - road test

Driving Belt - replacement

() See instructions in «Idle speed adjustment» section*

AFTER 18,000 KM AND AFTER 54,000 KM

Hub oil level - check

Spark plug/ electrode gap - check

Air filter - clean

Sliding blocks / variable speed rollers - check

Driving belt - check

Coolant level - check

Radiator - external cleaning/ check

Brake pads - check condition and wear

Brake fluid level - check

Tilt locking gripper control cable - adjustment

Electrical system and battery - check

Tyre pressure and wear - check

Vehicle and brake test - road test

Engine oil - change

Oil filter -Replacement

Valve clearance - Check

AFTER 24,000 KM AND AFTER 48,000 KM

Engine oil - replacement

Hub oil - change

Spark plug / electrode gap - check / replacement

Air filter - clean

Engine oil - change

Idle speed (*) - adjustment

Sliding block / variable speed rollers - change

Throttle lever - adjustment

Coolant level - check

Steering - adjustment

Brake control levers - greasing

Brake pads - check condition and wear

Brake fluid level - check

Tilt locking gripper control cable - adjustment

Transmission elements - lubrication

Safety locks - check

Suspensions - check

Electrical system and battery - check

Headlight - adjustment

Tyre pressure and wear - check

Vehicle and brake test - road test

Driving Belt - replacement

(*) See instructions in «Idle speed adjustment» section

AFTER 30,000 KM, AFTER 42,000 KM AND AFTER 66,000

KM

Hub oil level - check

Spark plug/ electrode gap - check

Air filter - clean

Sliding blocks / variable speed rollers - check

Driving belt - check

Coolant level - check

Brake pads - check condition and wear

Brake fluid level - check

Tilt locking gripper control cable - adjustment

Electrical system and battery - check

Tyre pressure and wear - check

Vehicle and brake test - road test

Engine oil - change

Oil filter -Replacement

AFTER 36.000 KM

Engine oil - replacement

Hub oil level - check

Spark plug / electrode gap - check / replacement

Air filter - clean

Engine oil - change

Valve clearance - Check

Idle speed (*) - adjustment

Sliding block / variable speed rollers - change

Throttle lever - adjustment

Driving belt - replacement

Coolant level - check

Radiator - external cleaning/ check

Steering - adjustment

Brake control levers - greasing

Brake pads - check condition and wear

Brake fluid hoses - replacement

Brake fluid level - check

Tilt locking gripper control cable - adjustment

Transmission elements - lubrication

Safety locks - check

Suspensions - check

Electrical system and battery - check

Headlight - adjustment

Tyre pressure and wear - check

Vehicle and brake test - road test

() See instructions in «Idle speed adjustment» section*

AFTER 72.000 KM

Engine oil - replacement

Hub oil - change

Spark plug / electrode gap - check / replacement

Air filter - clean

Engine oil - change

Valve clearance - Check

Idle speed (*) - adjustment

Sliding block / variable speed rollers - change

Throttle lever - adjustment

 Driving belt - replacement

 Coolant level - check

 Radiator - external cleaning/ check

 Steering - adjustment

 Brake control levers - greasing

 Brake pads - check condition and wear

 Brake fluid hoses - replacement

 Brake fluid level - check

 Tilt locking gripper control cable - adjustment

 Transmission elements - lubrication

 Safety locks - check

 Suspensions - check

 Electrical system and battery - check

 Headlight - adjustment

 Tyre pressure and wear - check

 Vehicle and brake test - road test

(*) See instructions in «Idle speed adjustment» section

RECOMMENDED PRODUCTS TABLE

Product	Description	Specifications
AGIP ROTRA 80W-90	Rear hub oil	SAE 80W/90 Oil that exceeds the requirements of API GL3 specifications

Product	Description	Specifications
AGIP CITY HI TEC 4T	Oil to lubricate flexible transmissions (throttle control)	Oil for 4-stroke engines
AGIP FILTER OIL	Oil for air filter sponge	Mineral oil with specific additives for increased adhesiveness
AGIP GP 330	Calcium complex soap-based grease with NLGI 2; ISO-L-XBCIB2	Grease (brake control levers, throttle grip)
AGIP CITY HI TEC 4T	Engine oil	SAE 5W-40, API SL, ACEA A3, JASO MA Synthetic oil
AGIP BRAKE 4	Brake fluid	FMVSS DOT 4 Synthetic fluid
SPECIAL AGIP PERMANENT fluid	coolant	Monoethylene glycol-based antifreeze fluid, CUNA NC 956-16

TABLE OF CONTENTS

A

Air filter: 56

B

Battery: 61

Brake: 59, 75

C

Clock: 12

D

Disc brake: 75

Display: 13

E

Engine oil: 50, 51

Engine stop: 17

F

Fuel: 24

Fuses: 62

H

Headlight: 68

Horn: 15

Hub oil: 52

I

Identification: 28

Immobilizer: 18, 21

Instrument panel: 10

K

Key switch: 14

Keys: 18

L

Light switch: 16

M

Maintenance: 13, 49, 93, 94

Mirrors: 74

S

Saddle: 22, 25–27

Scheduled maintenance: 94

Shock absorbers: 34

Spark plug: 55

Stand: 40

Start-up: 17

T

Tank: 24

Technical Data: 83

Top box: 28

Transmission: 41

Tyre pressure: 33

Tyres: 54



The descriptions and illustrations given in this publication are not binding. While the basic features as described and illustrated in this manual remain unchanged, PIAGGIO - GILERA reserves the right, at any time and without being required to update this publication beforehand, to make any changes to components, parts or accessory supplies, which it considers necessary to improve the product or which are required for manufacturing or construction reasons.

Not all versions shown in this publication are available in all Countries. The availability of individual versions should be confirmed with the official Piaggio sales network.

"© Copyright 2007 - PIAGGIO & C. S.p.A. Pontedera. All rights reserved. Reproduction of this publication in whole or in part is prohibited."

PIAGGIO & C. S.p.A. - After-Sales

V.le Rinaldo Piaggio, 23 - 56025 PONTEDERA (Pi)