

Vespa would like to thank you

for choosing one of its products. We have prepared this booklet to help you to get the very best from your scooter. Please read it carefully before riding the vehicle for the first time. It contains information, tips and precautions for using your vehicle. It also describes features, details and devices to assure you that you have made the right choice. We believe that if you follow our suggestions, you will soon get to know your new vehicle and use it for a long time at full satisfaction. This booklet forms an integral part of the vehicle; should the vehicle be sold, it must be transferred to the new owner.

Vespa GT 125 Euro 3



The instructions given in this booklet are intended to provide a clear, simple guide to using your scooter; details are also given of routine maintenance procedures and regular checks that should be carried out on the vehicle at an **Authorised PIAGGIO Dealer or Service Centre**. The booklet also contains instructions for simple repairs. Any operations not specifically described in this booklet require the use of special tools and/or particular technical knowledge: to carry out these operations refer to any **authorised PIAGGIO Dealer or Service Centre**.



Personal safety

Failure to completely observe these instructions will result in serious risk of personal injury.



Safeguarding the environment

Sections marked with this symbol indicate the correct use of the vehicle to prevent damaging the environment.



Vehicle intactness

The incomplete or non-observance of these regulations leads to the risk of serious damage to the vehicle and sometimes even the invalidity of the guarantee.

The signs that you see on this page are very important. They are used to highlight those parts of the booklet that should be read with particular care. As you can see, each sign consists of a different graphic symbol, making it quick and easy to locate the various topics.

INDEX

VEHICLE	7	Safe driving.....	30
Dashboard.....	8	MAINTENANCE	33
Analogue instrument panel.....	8	Engine oil level.....	34
Clock.....	9	Engine oil level check.....	35
Key switch.....	9	Engine oil top-up.....	35
Locking the steering wheel.....	10	Warning light (insufficient oil pressure).....	35
Releasing the steering wheel.....	10	Engine oil change.....	36
Switch direction indicators.....	10	Hub oil level.....	37
Horn button.....	11	Tyres.....	39
Light switch.....	11	Spark plug dismantlement.....	40
Start-up button.....	12	Removing the air filter.....	41
Engine stop button.....	12	Secondary air system.....	42
The immobilizer system.....	12	Cooling fluid level.....	43
Keys.....	13	Checking the brake oil level.....	45
Immobilizer device enabled indicator led.....	14	Battery.....	46
Operation.....	14	Use of a new battery.....	47
Programming the immobilizer system.....	15	Long periods of inactivity.....	48
Accessing the fuel tank.....	16	Fuses.....	49
Opening the saddle.....	17	Front light group.....	54
Identification.....	18	Headlight adjustment.....	56
Rear top box opening.....	19	Front direction indicators.....	57
USE	21	Rear optical unit.....	57
Checks.....	22	Rear turn indicators.....	58
Refuelling.....	22	Number plate light.....	59
Tyre pressure.....	24	Rear-view mirrors.....	59
Shock absorbers adjustment.....	25	Idle adjustment.....	60
Running in.....	26	Front and rear disc brake.....	61
Starting up the engine.....	26	Puncture.....	62
Precautions.....	27	Periods of inactivity.....	63
Difficult start up.....	27	Cleaning the vehicle.....	63
Stopping the engine.....	28	TECHNICAL DATA	69
Stand.....	29	Kit equipment.....	73
Automatic transmission.....	29	SPARE PARTS AND ACCESSORIES	75

Warnings.....	76
PROGRAMMED MAINTENANCE.....	79
Scheduled maintenance table.....	80

Vespa GT 125 Euro 3

Vespa®



**Chap. 01
Vehicle**

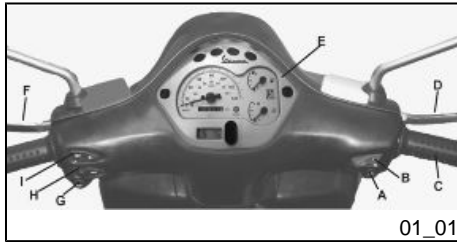

Dashboard (01_01)

- A = Starter button
- B = Engine block Run-Off switch
- C = Throttle control
- D = Front brake lever
- E = Instrument panel
- F = Rear brake control lever
- G = Horn button
- H = Turn indicator switch
- I = Light switch

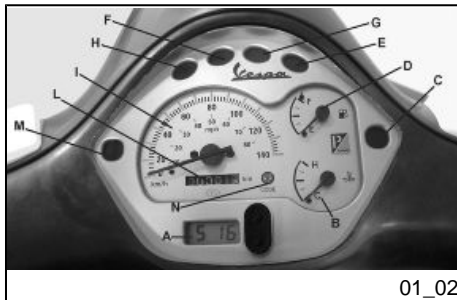

Analogue instrument panel (01_02)

- A = Digital clock with calendar
- B = Cooling liquid temperature gauge
- C = Right turn indicator warning light
- D = Fuel gauge
- E = Headlight warning light
- F = Low oil pressure warning light
- G = High-beam warning light
- H = Low fuel warning light
- I = Speedometer
- L = Odometer

M = Left turn indicator warning light

N = Antitheft device led (immobilizer)

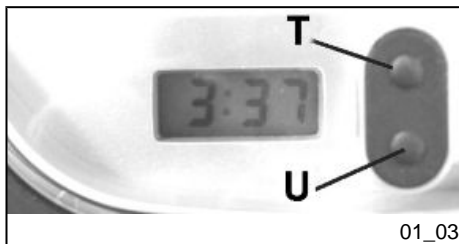

Clock (01_03)

Hours and minutes are displayed in a 1 to 12, AM or PM, format on the instrument panel.

Operating the function selection switch «**T**» month, day and seconds can be seen besides hours and minutes. In order to adjust the above mentioned functions, operate button «**U**». The digital clock is powered by a battery (battery life is about 2 years); lift the whole instrument panel to replace the battery. It is advisable to take your vehicle to an **Authorised Service Centre** for this operation.

WARNING



DEAD BATTERIES ARE HARMFUL TO THE ENVIRONMENT. THEY MUST DISPOSED OF IN SUITABLE CONTAINERS AS PRESCRIBED BY THE REGULATIONS IN FORCE.

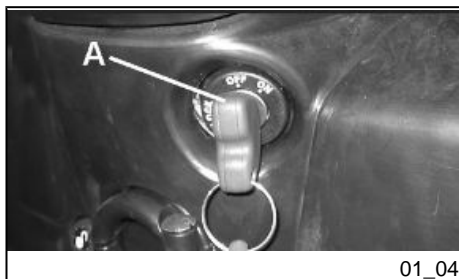

Key switch (01_04)

LOCK = ignition disabled, extractable key, mechanical antitheft device enabled.

OFF = ignition disabled, extractable key, mechanical antitheft device disabled.

ON = Ready to ignition position, non-extractable key, mechanical antitheft device disabled, lights on.

Locking the steering wheel

Turn the handlebar to the left (as far as it will go), turn the key to «**LOCK**» and remove the key.

CAUTION



DO NOT TURN THE KEY TO «LOCK» OR «KEY OFF» WHILE RIDING.

Releasing the steering wheel

Reinsert the key and turn it to «**OFF**».

CAUTION



DO NOT TURN THE KEY TO «LOCK» OR «KEY OFF» WHILE RIDING.

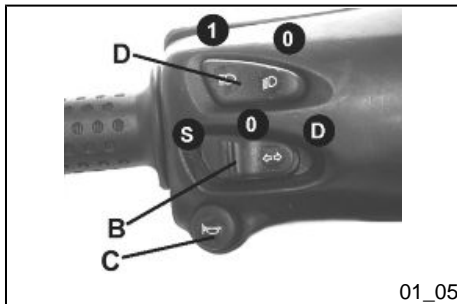

Switch direction indicators (01_05)

Lever towards "S" = Left turn indicator is switched on;

Lever towards "D" = Right turn indicator is switched on;

The lever returns automatically to position "0" and the turn indicator "B" remains on; press the lever to turn them off.

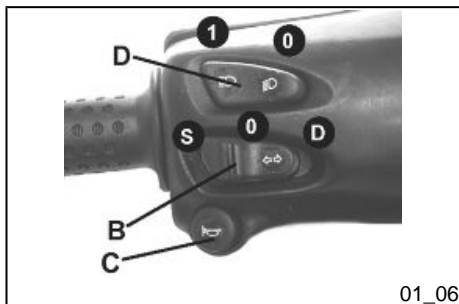

Horn button (01_06)

Push the «C» button to sound the horn.

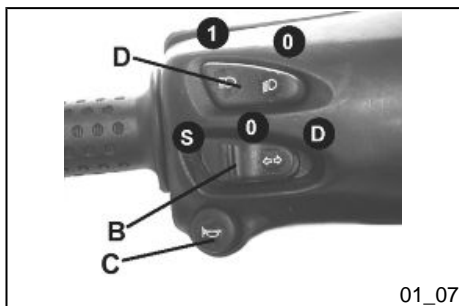

Light switch (01_07)

0 = Low-beam and tail light

1 = High-beam and tail light

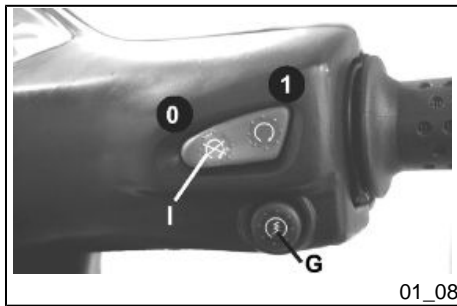

Start-up button (01_08)

Starter button "G"

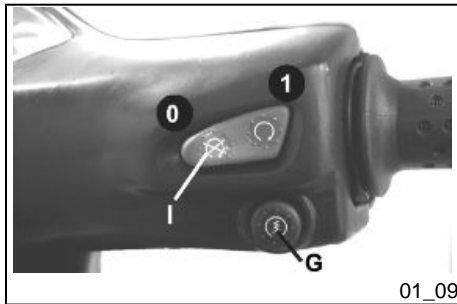

Engine stop button (01_09)

0 = OFF

1 = RUN

The immobilizer system

In order to enhance theft protection, the vehicle is equipped with a **«PIAGGIO IMMOBILIZER»** electronic engine locking device that is activated automatically when the starter key is removed. Upon start-up, the **«PIAGGIO IMMOBILIZER»** system checks the starter key, and only if this key is recognised will the immobilizer system allow the vehicle to be started.

Keys (01_10, 01_11, 01_12)

The vehicle is supplied with two types of keys. The red-handgrip key «**A**» is the "MASTER" key. Only a single copy of this key is supplied, which is necessary to program all your other keys and for your dealer to perform some maintenance operations. We therefore recommend that it be used only under exceptional circumstances. The black key «**B**» (single copy supplied) is used for normal operations and for start-up.

Together with the keys comes a CODE CARD which is imprinted with the mechanical code of the keys.

WARNING



LOSING THE RED KEY PREVENTS ANY REPAIRS OF THE "PIAGGIO IMMOBILIZER" SYSTEM AND THE ENGINE CONTROL UNIT.

WARNING



KEEP THE "CODE CARD" AND THE RED HANDGRIP KEY IN A SAFE PLACE (NOT ON YOUR VEHICLE).

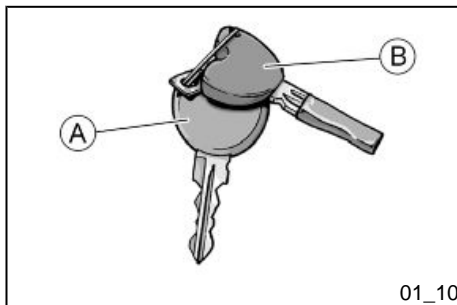

01_10

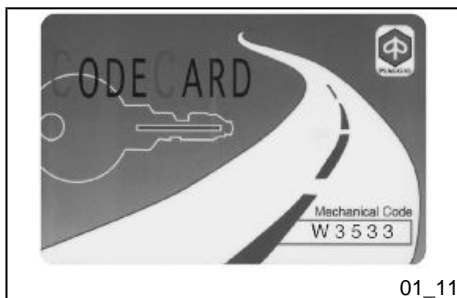

01_11

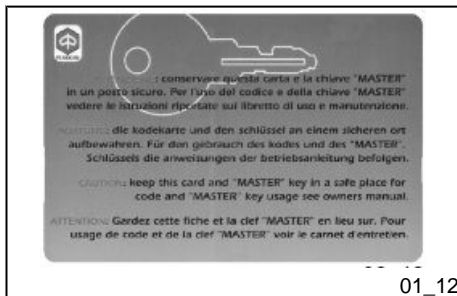

01_12

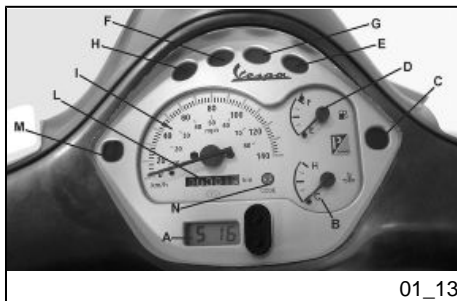

Immobilizerdevice enabled indicator led (01_13)

Activation of the «**PIAGGIO IMMOBILIZER**» system is signalled by a flashing warning light «**N**» (see «Analogue instrument panel» section).

In order to reduce battery discharge, the indicator LED turns off automatically after 48 hours of uninterrupted functioning.

Should the system fail, different LED flashing patterns will be provided by an **Authorised Piaggio-Gilera Service Centre** with information on the type of fault detected.

Operation

Every time the starter key is removed in the "**OFF**" or "**LOCK**" position, the safety system activates the immobilizer system. Turning the key to "**ON**" disables the engine lock, provided that the safety system recognises the code transmitted by the key. If the code is not recognised, turn the key first to "**OFF**" and then to "**ON**"; if the lock cannot be disabled, try with the other key supplied (red-coloured). If the engine cannot be started, contact an **Authorised Piaggio Service Centre**, which is provided with the electronic equipment required to detect and repair the system. The immobiliser is also activated in the engine is switched off with the RUN OFF switch. This happens even if the starter key is in position "**ON**".

When additional keys are required, please note that data storage (up to 3 keys max.) must be done on all keys, both new ones and existing ones. Take the key with the red grip and all the black keys supplied to an **Authorised Piaggio Service Centre**. The codes of keys not submitted for the new storage procedure are deleted from the memory. Any lost keys will therefore not be enabled to start the engine.

WARNING



EACH KEY HAS ITS OWN AND UNIQUE CODE, WHICH MUST BE STORED IN THE SYSTEM CONTROL UNIT MEMORY.

VIOLENT SHOCKS MAY AFFECT THE ELECTRONIC COMPONENTS OF THE KEY.

IF OWNERSHIP OF THE VEHICLE IS TRANSFERRED, THE RED HANDGRIP KEY (AS WELL AS THE OTHER KEYS) AND THE "CODE CARD" MUST ALSO BE TRANSFERRED TO THE NEW OWNER.

Programming the immobilizer system

Below is described the procedure to follow for programming the **PIAGGIO IMMOBILIZER** system and/or for storing other key codes. The programming procedure should be carried out with the engine stop switch set to «**RUN**».

Procedure start - red key

Insert the red handgrip key in the switch key (in "**OFF**" position) and turn it to "**ON**". After 1 - 3 seconds, turn the key to «**OFF** » again and pull it out.

Intermediate step - black key

After pulling out the red key, insert the black key within 10 seconds and promptly turn it to "**ON**". After 1-3 seconds, turn the key to "**OFF**" again and pull it out. In this way, a maximum of 3 black keys can be programmed by repeating the above procedure keeping the indicated times.

Final step - red key

After pulling out the last black key, insert the red key again and turn it to "**ON**" (this operation should be performed within 10 seconds of pulling out the previous key). Leave it in this position for 1 to 3 seconds and return it to «**OFF**».

Proper programming check

Insert the red key disabling the transponder (i.e., tilt the key cap by 90°) and turn the key to "ON". Perform the engine start-up operation. Ensure that the engine does not start. Insert the black key and repeat the start-up operation. Check that engine starts.

WARNING

SHOULD THE ENGINE START WITH THE RED KEY (WITH TRANSPONDER OFF), OR IN THE EVENT OF WRONG OPERATION DURING PROGRAMMING, REPEAT THE PROCEDURE FROM THE BEGINNING.



Accessing the fuel tank (01_14, 01_15, 01_16)

Repeat the operations of the previous section to open saddle. Then, unscrew cap «B» and the fuel tank can be reached.

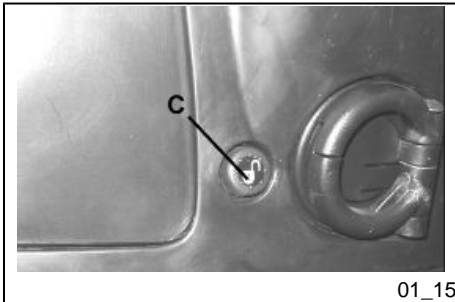

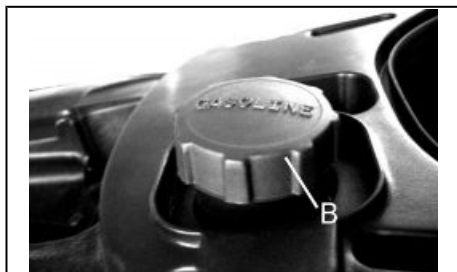

01_16

Opening the saddle (01_17, 01_18)

With the key set to «OFF» or «ON», or with engine on, it is possible to electrically open the saddle by pressing button «C». If the electric opening does not work, use the emergency lever "A". When the key is set to «LOCK» the saddle cannot be opened.



01_17

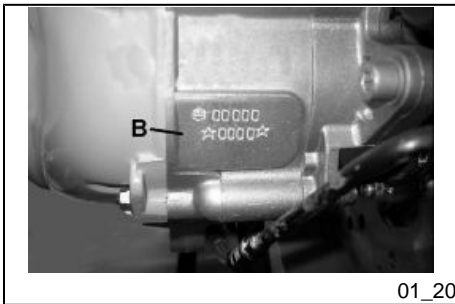
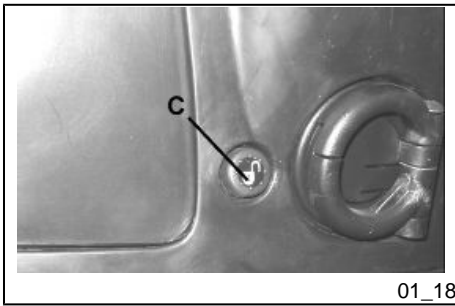

Identification (01_19, 01_20, 01_21)

The identification registration numbers consist of a prefix followed by a number stamped on both the chassis «A» and the engine «B». These numbers must always be indicated on spare parts requests. To read the chassis number, lift the saddle and remove the helmet compartment «C». We recommend checking that the chassis registration number stamped on the vehicle corresponds with that on the vehicle documentation.

CAUTION



BE REMINDED THAT ALTERING IDENTIFICATION REGISTRATION NUMBERS CAN LEAD TO SERIOUS PENAL SANCTIONS (IMPOUNDING OF THE VEHICLE, ETC.).



Rear top box opening (01_22)

Insert the key into the switch and press down until the glove compartment opens. If the switch is set to "**LOCK**", turn the key to "**OFF**" or "**ON**" before pressing it down.



Vespa GT 125 Euro 3

Vespa®



Chap. 02
Use

Checks

Before using the vehicle, check:

1. That there is enough fuel in the fuel tank.
2. That the fluid level for front and rear brakes is correct.
3. That tyres are properly inflated.
4. The correct functioning of tail lights, headlamp, turn indicators, stop light and license plate light.
5. The correct functioning of front and rear brakes.
6. The oil level in the gearcase.
7. Engine oil level.
8. The coolant level.



Refuelling (02_01, 02_02)

Fuel: lift up the saddle and unscrew the cap «**B**». Prescribed fuel: Minimum 95 octane unleaded petrol. The warning light «**C**» indicates when the petrol tank reserve has been reached.

WARNING



SWITCH OFF THE ENGINE BEFORE REFUELLING WITH PETROL.

PETROL IS HIGHLY INFLAMMABLE.

DO NOT SMOKE AND KEEP NAKED FLAMES AT A DISTANCE: FIRE HAZARD.

DO NOT INHALE FUEL FUMES.

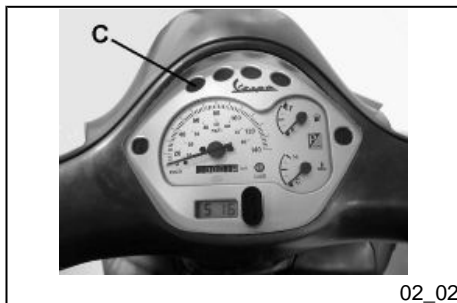

02_02

DO NOT ALLOW PETROL TO COME INTO CONTACT WITH HOT ENGINE OR ANY PLASTIC PARTS.

CAUTION



PETROL DAMAGES THE PLASTIC PARTS OF THE BODYWORK.

CAUTION



USING OILS OTHER THAN THOSE RECOMMENDED CAN SHORTEN THE LIFE OF THE ENGINE.

CAUTION



DO NOT USE THE VEHICLE TO THE COMPLETE EXHAUSTION OF THE FUEL; SHOULD THIS OCCUR, DO NOT ATTEMPT TO START THE ENGINE. TURN THE KEY SWITCH TO «OFF» AND TOP-UP THE TANK AS SOON AS POSSIBLE. FAILURE TO FOLLOW THESE GUIDELINES COULD DAMAGE THE FUEL PUMP AND/OR THE CATALYTIC CONVERTER.

Characteristic

Fuel tank capacity

About 10 l

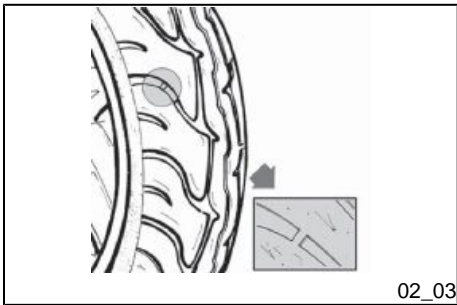

Tyre pressure (02_03)

Check the tyre pressure and wear periodically (roughly every 500 km). The tyres are equipped with wear indicators; the tyres should be replaced as soon as these indicators become visible on the tyre tread. Also check that tyres do not show cuts on the sides or irregular tread wear; if this occurs, go to an authorised workshop or at least a workshop equipped to perform the replacement.

CAUTION



TYRE PRESSURE SHOULD BE CHECKED WHEN TYRES ARE COLD. INCORRECT TYRE PRESSURE CAUSES ABNORMAL TYRE WEAR AND MAKES RIDING DANGEROUS.

TYRES MUST BE REPLACED WHEN THE TREAD REACHES THE WEAR LIMITS SET FORTH BY LAW.

Characteristic

Front tyre pressure

1.8 bar

Rear tyre pressure

2 bar

Rear tyre pressure - driver and passenger

2.2 bar

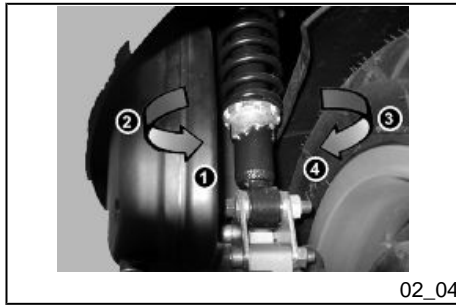

Shock absorbers adjustment (02_04)

The preloading of the springs can be adjusted to 4 positions acting on the ring nut located in the lower part of the shock absorbers with the specific spanner supplied.

Position 1: minimum preload: driver only

Position 2 medium preloading: rider only

Position 3 medium preloading: rider and passenger

Position 4: maximum preloading: rider, passenger, and luggage.

In order to carry out this operation you will need to use the specific spanner in the kit.

CAUTION



RIDING THE VEHICLE WITH THE SPRING PRELOADING NOT CORRECTLY SET FOR THE RIDER AND POSSIBLE PASSENGER, COULD REDUCE THE COMFORT OF THE RIDE AND THE PRECISION OF THE STEERING.

WARNING



WE RECOMMEND WEARING GLOVES WHILE CARRYING OUT THIS OPERATION IN ORDER TO AVOID INJURIES.

WARNING



WE STRONGLY RECOMMEND NOT TO ADJUST BOTH SHOCK ABSORBERS WITH DIFFERENT PRELOADING



Running in (02_05)

WARNING



DURING THE FIRST 1000 KM DO NOT RIDE THE VEHICLE OVER 80% OF ITS MAXIMUM SPEED. AVOID TWISTING THE THROTTLE GRIP FULLY OR KEEPING A CONSTANT SPEED ALONG LONG SECTIONS OF ROAD. AFTER THE FIRST 1000 KM, GRADUALLY INCREASE SPEED UNTIL REACHING THE MAXIMUM PERFORMANCE.

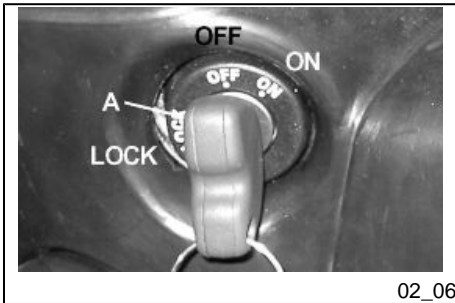

Starting up the engine (02_06, 02_07)

To start the engine it is necessary, before pressing the starter button, to pull and keep pulled the front or rear brake lever, which activates the appropriate switch allowing start-up.

1. Rest the vehicle on its centre-stand, ensuring the rear wheel is not touching the ground.
2. Maintain the throttle grip «E» completely untwisted.
3. insert key into ignition switch «A» and turn it to "ON".
4. Make sure that the «B» "OFF-ON" switch is set to ON.
5. Pull lever «C» of the front or rear brake and then activate the starter button «D».

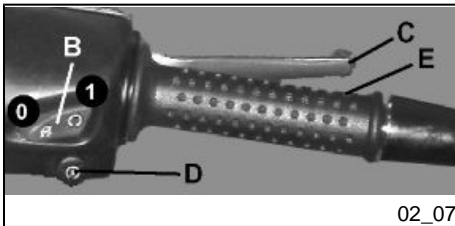

WARNING



THE AUTOMATIC TRANSMISSION MAKES THE REAR WHEEL TURN EVEN WHEN THE THROTTLE IS SLIGHTLY TWISTED. RELEASE THE BRAKE CAREFULLY AFTER STARTING, AND THEN ACCELERATE GRADUALLY.

CAUTION

DO NOT START-UP THE ENGINE IN CLOSED AREAS BECAUSE EXHAUST GASES ARE TOXIC.

Precautions**WARNING**

NEVER STRESS THE ENGINE AT LOW TEMPERATURES IN ORDER TO AVOID POSSIBLE DAMAGE. BE CAREFUL NEVER TO EXCEED THE MAXIMUM SPEED WHILE RUNNING DOWNHILL, IN ORDER TO AVOID DAMAGING THE ENGINE. IN ANY CASE, IN ORDER TO PRESERVE THE ENGINE FROM PROLONGED OVERREVVING, THE REVOLUTION LIMITER WILL BE ACTIVATED IF THE ENGINE SPEED EXCEEDS THE ESTABLISHED THRESHOLD. DO NOT ACTIVATE THE REVOLUTION LIMITER RECURRENTLY SO AS TO AVOID DAMAGING THE CATALYTIC CONVERTER.

WARNING

AFTER A LONG DISTANCE COVERED AT THE MAXIMUM SPEED, DO NOT STOP THE ENGINE IMMEDIATELY, BUT LET IT RUN AT IDLE FOR A FEW SECONDS.

Difficult start up

In the rare case of engine flooding, to facilitate start-up, it is possible to try to put the vehicle into action with the gas hand grip partially or completely open. It is however

necessary, once the engine is started, to take your vehicle to an **Authorised Service Centre** to determine the cause of this problem and to re-establish the vehicle proper functioning.

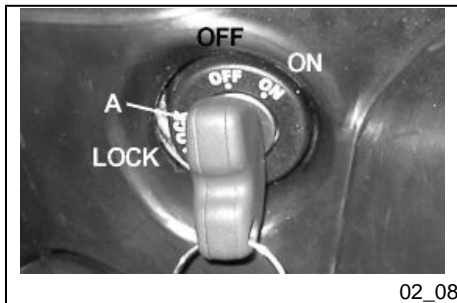

Stopping the engine (02_08, 02_09)

Fully untwist the throttle grip and then turn the switch «A» to "OFF" (extractable key), or turn switch «B» to "OFF".

CAUTION



DUE TO THE HIGH TEMPERATURES THE CATALYTIC CONVERTER CAN REACH, ALWAYS TAKE CARE, WHEN PARKING THE VEHICLE, THAT THE EXHAUST DOES NOT COME INTO CONTACT WITH FLAMMABLE MATERIALS, TO AVOID SERIOUS BURNS.

CAUTION



DO NOT SHUT OFF THE ENGINE WHILE THE VEHICLE IS MOVING. UNBURNED FUEL COULD ENTER THE CATALYTIC CONVERTER AND BURN, CAUSING THE CONVERTER TO OVERHEAT AND POSSIBLY DESTROYING IT.

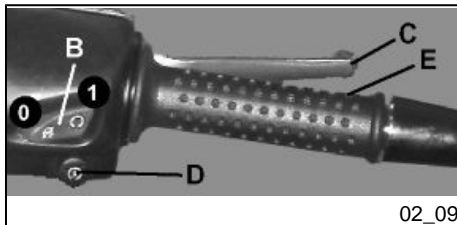

Stand (02_10)

CENTRE STAND

Push with your foot on the centre stand's fork «F» while lifting the vehicle backward, holding onto the handlebar.



02_10

Automatic transmission (02_11, 02_12, 02_13)

To ensure simple, pleasurable riding, the vehicle is equipped with automatic transmission with regulator and centrifugal clutch. The system is designed to provide the best performance (acceleration and consumption) while riding on both flat roads and uphill.

If you have to stop on an uphill slope (traffic lights, traffic jam, etc.) **use only the brake to keep the vehicle still, leaving the engine running at idle speed. Using the engine to keep the vehicle still can cause the clutch to overheat, due to the friction of the clutch mechanism itself against the clutch bell.**

It is therefore recommended to avoid conditions of prolonged clutch slippage (other than those previously indicated) like driving uphill fully laden on steep slopes or starting off with driver and passenger at slopes greater than 25%.

Observe the following precautions if the clutch overheats:

1. Do not continue riding in such conditions.
2. Let the clutch cool down with the engine at idle speed for a few minutes.



02_11



02_12



02_13



02_14



02_15

Safe driving (02_14, 02_15, 02_16)

Some simple tips are provided below that will enable you to use your scooter on a daily basis in greater safety and peace of mind. Your skill and your mechanical knowledge are the basis of a safe ride. We recommend trying out the vehicle in traffic - free zones, in order to acquire a good knowledge of the vehicle it self.

1. Before riding off, remember to put on your helmet and fasten it correctly.
- 2.Reduce speed on rough roads and drive with care.
3. After driving on a long stretch of wet road without using the brakes, the braking effect is initially lower. In these conditions, it is a good idea to apply the brakes from time to time.
4. Do not brake hard on wet, unsurfaced or slippery road surfaces.
5. Avoid riding off by mounting the scooter when resting on the support. In any case, the rear wheel should not be turning when it comes into contact with the ground, in order to avoid abrupt departures.
6. If driving over roads affected by sand, mud, snow mixed with salt, etc. We advise you to frequently clean the brake disc with a mild detergent to prevent the accumulation of abrasive elements inside the eyelets leading to premature wear on the brake pads.

**CAUTION**

ALWAYS RIDE WITHIN YOUR LIMITS RIDING UNDER THE INFLUENCE OF ALCOHOL OR OTHER DRUGS AND CERTAIN MEDICINES IS EXTREMELY DANGEROUS.

CAUTION

ANY CHANGES TO THE VEHICLE PERFORMANCE AS WELL AS ALTERATIONS TO ORIGINAL STRUCTURAL PARTS IS STRICTLY FORBIDDEN BY LAW, AND RENDERS THE VEHICLE NO LONGER CONFORMING TO THE APPROVED TYPE AND DANGEROUS FOR RIDING.

CAUTION

DO NOT ADJUST THE MIRRORS WHILE RIDING. THIS COULD CAUSE YOU TO LOOSE CONTROL OVER THE VEHICLE.

WARNING

IN ORDER TO PREVENT ANY ACCIDENTS RIDE VERY CAREFULLY AFTER ADDING ACCESSORIES AND WHILE CARRYING LUGGAGE. THE ADDITION OF ACCESSORIES AND LUGGAGE CAN REDUCE YOUR SCOOTER STABILITY AND PERFORMANCE, AS WELL AS THE LEVEL OF SAFETY DURING USE. NEVER DRIVE THE SCOOTER EQUIPPED WITH ACCESSORIES AT A SPEED HIGHER THAN 100 km/h (see section "SPARE PARTS AND ACCESSORIES")

Vespa GT 125 Euro 3

Vespa®



Chap. 03 Maintenance

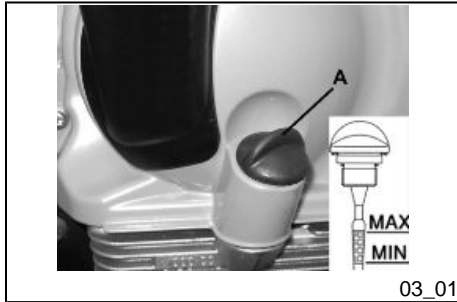

Engine oil level (03_01)

In 4T engines, engine oil is used to lubricate the distribution elements, main bearings and thermal group. **An insufficient quantity of oil can seriously damage the engine.** In all four-stroke engines, a loss of efficiency in oil performance and certain consumption should be considered normal. Consumption can particularly reflect the conditions of use (i.e. when driving at 'full acceleration' all the time, oil consumption increases). The replacement intervals provided for by the maintenance programme are defined depending on the total content of oil in the engine and the average consumption measured following standardised methods. **In order to prevent any problems, we recommend checking oil level more frequently than indicated in the Scheduled Maintenance table or before setting off on long journeys. The vehicle is, however, equipped with an oil pressure warning light on the instrument panel.**

Engine oil level check (03_02)

Every time the scooter is used, a visual check should be made on the level of the engine oil when the engine is cold. The oil level should be somewhere between the **MAX** and **MIN** index marks on the level bar; the check must be made with the scooter upright, resting on the centre stand. If the check is carried out after the vehicle has been used, and therefore with a hot engine, the level line will be lower; in order to carry out a correct check, wait at least 10 minutes after the engine has been stopped so as to get the correct level.

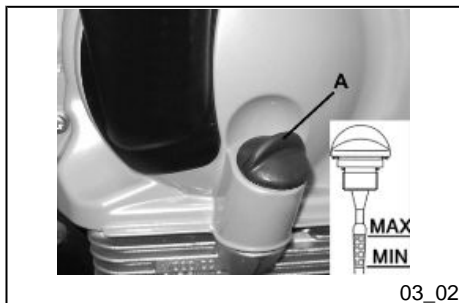

Engine oil top-up

Any topping up with oil must be carried out after checking the oil level by adding oil, but **never exceeding the MAX level**. Getting an oil level between the **MIN** and **MAX** marks requires approx. 400 cm³ of oil. Every 3000 km, however, take your scooter to an **Authorised Piaggio Service Centre** to have the engine oil level should be checked and if necessary, topped up.

Warning light (insufficient oil pressure)

The vehicle is equipped with a warning light that comes on when the key is turned to «ON». However, this light should come off once the engine has been started. **If the light comes on while braking, at idle speed or while turning a corner, it is necessary to check the oil level and top it up if required. If after having topped-up the oil, the warning light still comes on while braking, at idle speed or while turning a corner, it will be necessary to take your vehicle to an Authorised Service Centre.**

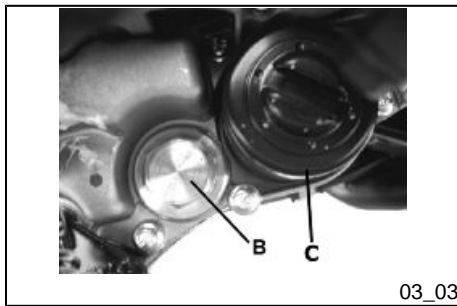

03_03

Engine oil change (03_03)

The oil and the cartridge filter «C» must be changed after 1000 km and every 6000 km at an **Authorised Piaggio Service Centre**. The engine should be emptied by draining the oil from the drainage plug «B» of the gauze filter on the flywheel side. In order to facilitate the oil drainage, loosen the cap/dipstick. Since a certain quantity of oil still remains in the circuit, filling must be done with approx $600 \div 650 \text{ cm}^3$ of oil through the cap «A». Then start up the scooter, leave it running for a few minutes and switch it off: after five minutes, check the level and if necessary top-up **without exceeding the MAX. level**. The cartridge filter must be replaced at every oil change. For top-ups and changes, use new oil of the recommended type.

WARNING



RUNNING THE ENGINE WITH INSUFFICIENT LUBRICATION OR WITH INADEQUATE LUBRICANTS ACCELERATES THE WEAR AND TEAR OF THE MOVING PARTS AND CAN CAUSE IRRETRIEVABLE DAMAGE.

WARNING



EXCESSIVE OIL LEVEL AT TOP-UPS CAN LEAD TO SCALE FORMATION AND VEHICLE MALFUNCTION.

CAUTION



USED OILS CONTAIN SUBSTANCES HARMFUL TO THE ENVIRONMENT. FOR OIL CHANGE, CONTACT AN AUTHORISED SERVICE CENTRE WHICH IS EQUIPPED TO DISPOSE OF USED OILS IN AN ENVIRONMENTALLY FRIENDLY AND LEGAL WAY.

CAUTION

USING OILS OTHER THAN THOSE RECOMMENDED CAN SHORTEN THE LIFE OF THE ENGINE.

Recommended products**AGIP CITY HI TEC 4T**

Engine oil

SAE 5W-40, API SL, ACEA A3, JASO MA Synthetic oil

Hub oil level (03_04, 03_05)

Check the oil in the rear hub. To check the rear hub oil level, proceed as follows:

- 1) Park the scooter on level ground and rest it on its stand.
- 2) Unscrew dipstick "A", wipe it clean with a cloth, reinsert it and **tighten completely**.
- 3) Pull out the dipstick and check that the oil level is above the first notch from the bottom.
- 4) Reinsert the dipstick and ensure that it is tightened correctly.

N.B.

THE NOTCHES ON THE HUB OIL LEVEL DIPSTICK, EXCEPT THE ONE INDICATING THE MAX LEVEL, REFER TO OTHER MODELS BY THE MANUFACTURER AND HAVE NO SPECIFIC FUNCTION FOR THIS MODEL.



03_04

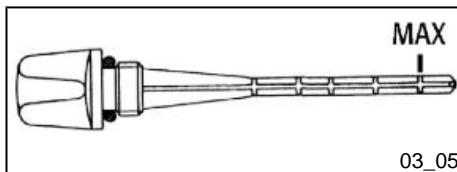

03_05

CAUTION



RIDING THE VEHICLE WITH INSUFFICIENT HUB LUBRICATION OR WITH CONTAMINATED OR IMPROPER LUBRICANTS ACCELERATES THE WEAR AND TEAR OF THE MOVING PARTS AND CAN CAUSE SERIOUS DAMAGE.

CAUTION



USED OIL CAN HARM THE ENVIRONMENT. COLLECTION AND DISPOSAL SHOULD BE CARRIED OUT IN COMPLIANCE WITH REGULATIONS IN FORCE.

CAUTION



AN EXCESSIVE QUANTITY OF OIL CAN LEAD TO SPILL OVER, WHICH MAY CAUSE THE ENGINE AND THE WHEEL TO GET DIRTY.

CAUTION



WHEN REPLACING THE HUB OIL DO NOT LET THE OIL COME INTO CONTACT WITH THE REAR BRAKE DISC.

CAUTION



FOR OIL REPLACEMENT, CONTACT ANY AUTHORISED SERVICE CENTRE AS THEY ARE EQUIPPED TO DISPOSE OF USED OILS IN AN ENVIRONMENTALLY FRIENDLY AND LEGAL WAY.

Recommended products

AGIP ROTRA 80W-90

Rear hub oil

SAE 80W/90 Oil that exceeds the requirements of API GL3 specifications

Characteristic

rear hub oil capacity

Capacity: approx. 150 cm³

Tyres (03_06)

Check tyre pressure periodically (about every 500 km). Tyres feature wear indicators; replace tyres as soon as these indicators become visible on the tyre tread. Also check that the tyres do not show signs of splitting at the side or irregular tread wear; if this occurs, go to an authorised workshop or at least to a workshop equipped to perform the replacement.

CAUTION



TYRE PRESSURE SHOULD BE CHECKED WHEN TYRES ARE COLD. INCORRECT TYRE PRESSURE CAUSES ABNORMAL TYRE WEAR AND MAKES RIDING DANGEROUS.

TYRES MUST BE REPLACED WHEN THE TREAD REACHES THE WEAR LIMITS SET FORTH BY LAW.

Characteristic

Front tyre pressure

1.8 bar

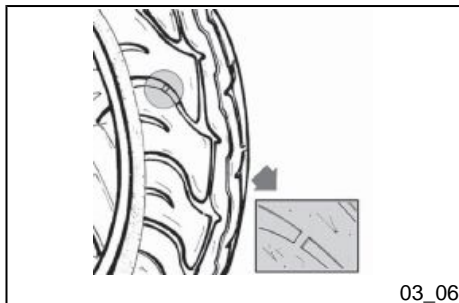

03_06

Rear tyre pressure

2 bar

Rear tyre pressure - driver and passenger

2.2 bar

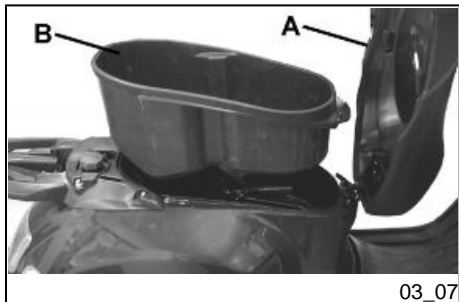

03_07



03_08

Spark plug dismantlement (03_07, 03_08, 03_09)

Proceed as follows:

1. lift the saddle «A»
2. lift the helmet compartment «B» and reach into the spark plug with your hand;
3. remove the spark plug HV wire cap «C»;
4. unscrew the spark plug using the spark plug spanners «D» supplied;
5. When refitting, place the spark plug in the hole at the due inclination and screw it by hand until it is finger tight;
6. use the box-spanner «D» supplied only for locking;
7. push cap «C» fully on the spark plug.

CAUTION

THE SPARK PLUG MUST BE REMOVED WHEN THE ENGINE IS COLD. THE SPARK PLUG SHOULD BE CHECKED EVERY 6,000 KM AND REPLACED EVERY 12,000 KM. THE USE OF NON-CONFORMING IGNITION CONTROL UNITS AND SPARK PLUGS OTHER THAN THOSE PRESCRIBED CAN SERIOUSLY DAMAGE THE ENGINE

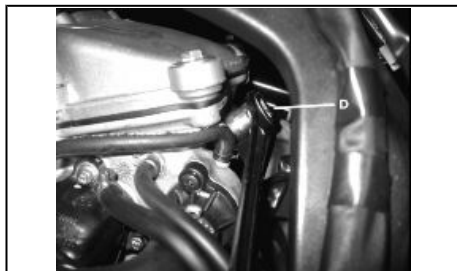

03_09

CAUTION

THE USE OF SPARK PLUGS OTHER THAN THOSE RECOMMENDED OR A SHIELDLESS SPARK PLUG CAP COULD CAUSE DISTURBANCES TO THE SYSTEM.

Characteristic**Spark plug**

Champion RG 4 HC



03_10

Removing the air filter (03_10, 03_11, 03_12, 03_13)

Proceed as follows:

1. undo the fixing screws «A» and remove the left side fairing;
2. remove the helmet compartment;
3. unscrew the fixing screws «B» that can be reached after removing the helmet compartment;
4. unscrew the screws «C» and remove the air filter cover.



03_11

Remove the filtering element and clean it with water and shampoo; then dry it with a clean cloth and short blasts of compressed air. Finally, immerse it in a mixture containing 50% oil of the recommended type and 50% petrol. Then gently squeeze the filter element between your hands, allow it to drip and then refit it. Possible oil or water deposits can be eliminated by removing the two rubber caps «D».

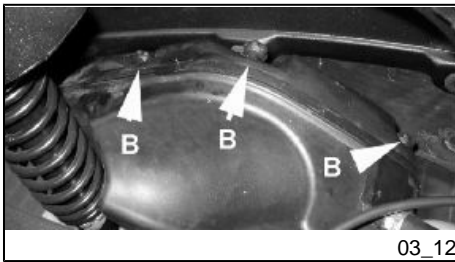

03_12

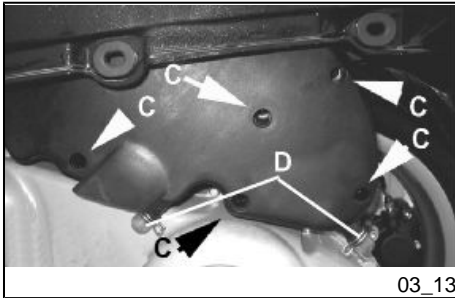

03_13

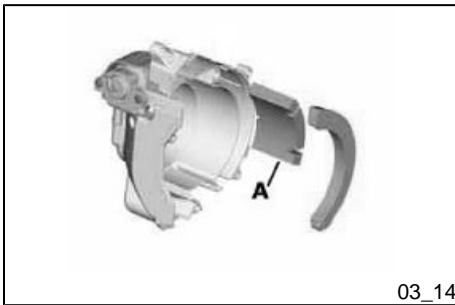

03_14

CAUTION

IF THE VEHICLE IS USED ON DUSTY ROADS, IT IS NECESSARY TO SERVICE THE AIR FILTER MORE OFTEN TO AVOID DAMAGING THE ENGINE.

CAUTION

IN ORDER NOT TO DAMAGE THE VEHICLE PLASTIC COVERS CONTACT AN AUTHORISED SERVICE CENTRE TO HAVE THE AIR FILTER CLEANED.

Recommended products**AGIP FILTER OIL**

Oil for air filter sponge

Mineral oil with specific additives for increased adhesiveness

Secondary air system (03_14, 03_15)

In order to reduce polluting emissions, the vehicle is furnished with a catalytic converter in the muffler.

To favour the catalytic process, an extra amount of oxygen is added to the exhaust through a secondary air system (SAS).

This system allows more oxygen to be added to the unburned gas before it reaches the converter, thus improving the action of the catalytic converter.

The air enters the head through an exhaust tube and is purified by 2 filters, one internal "A" and one external "B".

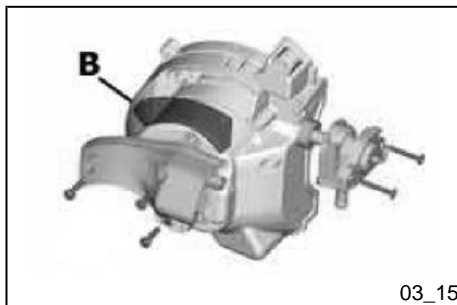

03_15

The system is provided with a control valve that prevents its functioning while decelerating, to avoid unwanted noise.

To ensure the best functioning of the SAS system, every two years the scooter should be taken to an **authorised Piaggio service centre** to have the filters cleaned (Scheduled maintenance section).

The filter sponge should be cleaned with water and mild soap, then it should be dried with a cloth and slight blows of compressed air.

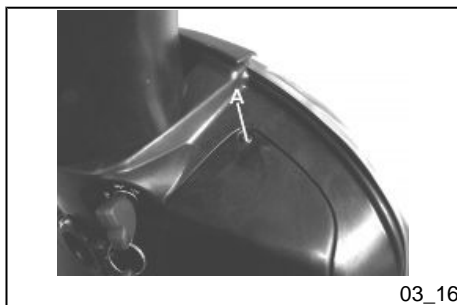

03_16

Cooling fluid level (03_16, 03_17)

The engine is cooled by a forced-circulation coolant system. The cooling circuit holds coolant consisting of a mixture of 50% de-ionised water and 50% glycol ethylene-based antifreeze solution with corrosion inhibitors. The recommended coolant is supplied premixed and ready to use. To ensure correct engine operation, the needle on the coolant temperature gauge must be at the centre of the scale. If the needle enters the red zone, turn off the engine, allow the engine to cool then check the coolant level; if the level is OK, take your scooter to an **Authorised Piaggio Service Centre**. If when using your scooter at a low gear the coolant temperature exceeds the above values, shut off the engine and let it cool down. Then check the coolant level; if level is OK, take your scooter to an **Authorised Piaggio Service Centre**. Check coolant when the engine is cold at the intervals indicated in the scheduled maintenance table, following the steps below.

- a) Place the scooter in a vertical position on the stand.
- b) Unscrew the fixing screw «A» and remove the cover.
- c) Check the fluid level according to the two marks- MIN and MAX «B» on the reservoir
- d) Top up if the fluid level is below the MIN level on the scale inside the expansion tank. The fluid level must always be between the MIN and MAX levels.

If the fluid is near the minimum level, top-up only when the engine is cold. If the coolant needs to be topped up frequently or the expansion tank is completely dry, check the



03_17

cooling system for the cause of the problem. Have the cooling system checked at an **Authorised Piaggio Service Centre**. Coolant must be changed every 2 years at an **Authorised Piaggio Service Centre**.

WARNING

TO AVOID THE RISK OF SCALDING, DO NOT UNSCREW THE EXPANSION TANK COVER WHILE THE ENGINE IS STILL HOT.

WARNING

TO PREVENT AVOID HARMFUL FLUID LEAKAGE WHILE RIDING, ENSURE THAT THE LEVEL NEVER EXCEEDS THE MAXIMUM VALUE.

TO ENSURE CORRECT ENGINE OPERATION, KEEP THE RADIATOR GRILLE CLEAN.

Recommended products**SPECIAL AGIP PERMANENT fluid***coolant*

Monoethylene glycol-based antifreeze fluid, CUNA NC 956-16

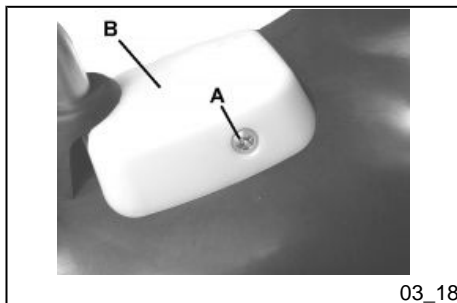

03_18

Checking the brake oil level (03_18, 03_19)

The brake fluid reservoirs are located on the pumps under the front handlebar cover (front on the right-hand side, rear on the left-hand side). The procedures to checking the brake fluid level for the front and rear brakes are identical.

Proceed as follows:

1. rest the scooter on its centre stand and make sure the handlebar is centred;
2. loosen screw "A" and remove cover "B";
3. check the fluid level through the respective sight glass "C".

A certain lowering of the level is caused by wear on the pads. Should the level appear to be below the minimum mark, please contact your nearest **Authorised PIAGGIO Dealer or Service Centre** in order to have braking system thoroughly inspected. Proceed as follows:

Remove tank cover «D» and loosen the two screws «E» and top-up the brake fluid level using only the prescribed brake fluid and without exceeding the maximum level.

Under normal climatic conditions, the brake fluid should be replaced every 2 years. This operation must be carried out by trained technicians; take your scooter to a **PIAGGIO Dealer or authorised Service Centre**.

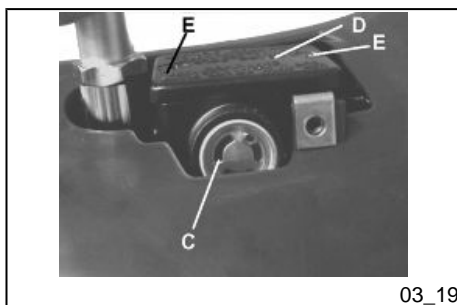

03_19

WARNING



ONLY USE DOT 4 CLASS BRAKE FLUIDS. BRAKING CIRCUIT FLUIDS ARE HIGHLY CORROSIVE. MAKE SURE THAT IT DOES NOT COME INTO CONTACT WITH THE PAINTWORK

.

CAUTION



AVOID CONTACT OF BRAKE FLUID WITH EYES, SKIN, AND CLOTHING. IN CASE OF CONTACT, RINSE WITH WATER. THE BRAKING CIRCUIT FLUID IS

HYGROSCOPIC, THAT IS, IT ABSORBS HUMIDITY FROM THE SURROUNDING AIR. IF THE HUMIDITY IN THE BRAKING FLUID EXCEEDS A CERTAIN VALUE, IT WILL LEAD TO INEFFICIENT BRAKING. NEVER USE BRAKING FLUID KEPT IN CONTAINERS THAT HAVE ALREADY BEEN OPENED, OR PARTIALLY USED.

Recommended products

AGIP BRAKE 4

Brake fluid

FMVSS DOT 4 Synthetic fluid

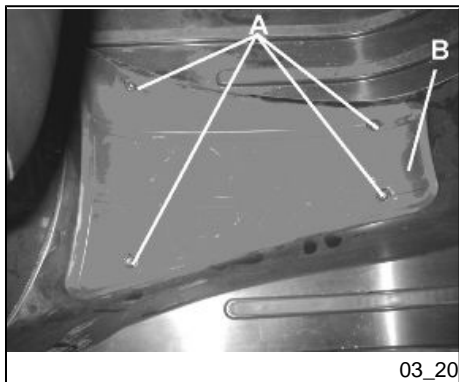

Battery (03_20, 03_21, 03_22)

To reach the battery «D », proceed as follows:

1. rest the scooter on its centre stand;
2. unscrew the 4 screws «A», remove the footrest «B».
3. remove the two battery fixing screws «C».

The battery is the electrical device that requires the most frequent inspections and diligent maintenance. The main points of maintenance to be observed are as follows:

CAUTION



IN ORDER TO AVOID DAMAGING THE ELECTRICAL SYSTEM, NEVER DISCONNECT THE WIRING WHILE THE ENGINE IS RUNNING. DO NOT TIP THE SCOOTER TOO MUCH IN ORDER TO AVOID DANGEROUS LEAKS OF BATTERY ELECTROLYTE



03_21

CAUTION

ELECTROLYTE CONTAINS SULPHURIC ACID: AVOID CONTACT WITH EYES, SKIN AND CLOTHES. IN CASE OF ACCIDENTAL CONTACT, RINSE WITH ABUNDANT WATER AND CONSULT A DOCTOR.

WARNING

USED BATTERIES ARE HARMFUL FOR THE ENVIRONMENT. COLLECTION AND DISPOSAL SHOULD BE CARRIED OUT IN COMPLIANCE WITH REGULATIONS IN FORCE.

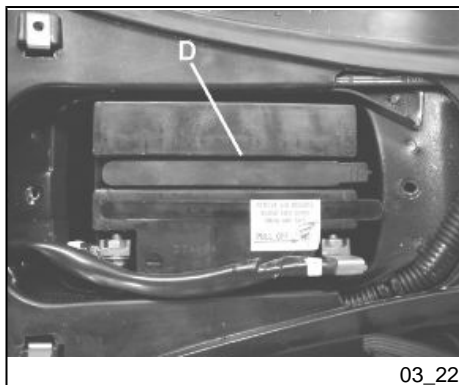

03_22

Use of a new battery

Ensure that the terminals are connected correctly and check voltage.

CAUTION

DO NOT REVERSE THE POLARITY: RISK OF SHORT CIRCUIT AND DAMAGE TO THE ELECTRICAL SYSTEM.

WARNING

USED BATTERIES ARE HARMFUL FOR THE ENVIRONMENT. COLLECTION AND DISPOSAL SHOULD BE CARRIED OUT IN COMPLIANCE WITH REGULATIONS IN FORCE.

Long periods of inactivity

Battery performance will decrease if the vehicle is not used for a long time. This is the result of the natural phenomenon of battery discharging plus residual absorption by vehicle components with constant power consumption. Poor battery performance may also be due to environmental conditions and the cleanliness of the poles. In order to avoid difficult starts and/or irreversible damage to the battery, follow any of these steps:

- **At least once a month** start the engine and run it slightly above idle speed for 10-15 minutes. This keeps all the engine components, as well as the battery, in good working order.
- Take your vehicle to a garage (as indicated in the «Vehicle not used for extended periods» section) to have the battery removed. Have the battery cleaned, charged fully and stored in a dry, ventilated place. Recharge **at least once every two months**.

N.B.

THE BATTERY MUST BE CHARGED WITH A CURRENT EQUAL TO 1/10 OF THE RATED CAPACITY OF THE BATTERY AND FOR NOT LONGER THAN 10 HOURS. CONTACT AN AUTHORISED SERVICE CENTRE TO CARRY OUT THIS OPERATION SAFELY. WHEN REFITTING THE BATTERY MAKE SURE THE LEADS ARE CORRECTLY CONNECTED TO THE TERMINALS.

WARNING

DO NOT DISCONNECT THE BATTERY CABLES WITH THE ENGINE RUNNING, THIS CAN CAUSE PERMANENT DAMAGE TO THE VEHICLE ELECTRONIC CONTROL UNIT.

WARNING

USED BATTERIES ARE HARMFUL FOR THE ENVIRONMENT. COLLECTION AND DISPOSAL SHOULD BE CARRIED OUT IN COMPLIANCE WITH REGULATIONS IN FORCE.

Fuses (03_23, 03_24)

The electrical system is equipped with:

1. six protection fuses «**A**» located in the glove compartment to the left
2. one 15A fuse «**B**» located under the helmet compartment under the saddle hinge latch.

The chart shows the position and characteristics of the fuses in the vehicle.

CAUTION

BEFORE REPLACING A BLOWN FUSE, FIND AND SOLVE THE FAILURE THAT CAUSED IT TO BLOW. NEVER TRY TO REPLACE A FUSE WITH ANY OTHER MATERIAL (A PIECE OF ELECTRIC WIRE, FOR INSTANCE).

CAUTION



MODIFICATIONS OR REPAIRS TO THE ELECTRICAL SYSTEM, PERFORMED INCORRECTLY OR WITHOUT STRICT OBSERVANCE OF THE TECHNICAL SPECIFICATIONS OF THE SYSTEM, CAN CAUSE OPERATING ERRORS AND RISK OF FIRE.

FUSES

Fuse 1	Current rating: 10 A Protected circuits: High-/low-beam headlight bulb, high-beam warning light.
--------	---

Fuse 2	Current rating: 7.5 A Protected circuits: Saddle-opening actuator, immobilizer LED, anti-theft device pre-installation, key switch
--------	---

Fuse 3	Current rating: 7.5 A Protected circuits: Horn, anti-theft device pre-installation, oil warning light sensor, water temperature gauge, thermistor, fuel gauge, low fuel warning light, fuel level transmitter.
--------	---

Fuse 4	Current rating: 5 A
--------	----------------------------

Protected circuits: Panel lighting
warning lights. tail lights, license
plate light.

Fuse 5

Current rating: 5 A

Protected circuits: Stop light,
starter motor.

Fuse 6

Current rating: 3 A

Protected circuits: Electric fuel
pump

Fuse 7

Current rating: 15A

Protected circuits: General

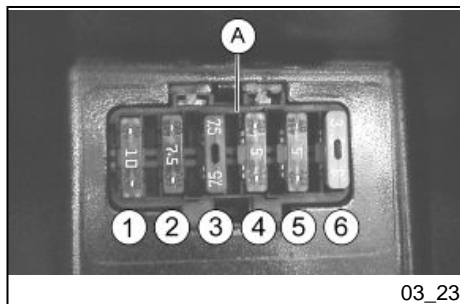

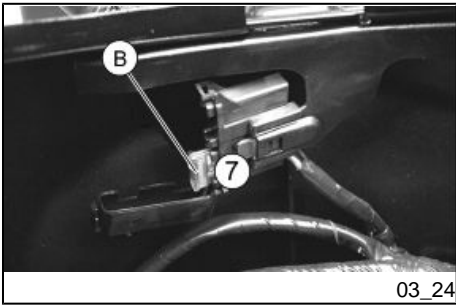

BULBS

Low-/high-beam light bulb	Type: HALOGEN (H4) Power: 12V - 55/60W Quantity: 1
---------------------------	---

Front tail light bulb	Type: ALL GLASS Power: 12V - 5W Quantity: 2
-----------------------	--

Licence plate light bulb	Type: ALL GLASS Power: 12V - 5W Quantity: 1
--------------------------	--

Front turn indicator bulb	Type: ALL GLASS Power: 12V - 5W
---------------------------	--

Quantity: 4

Rear turn indicator bulb	Type: SPHERICAL (AMBER) Power: 12V - 10W Quantity: 2
--------------------------	---

Rear tail light bulb	Type: ALL GLASS Power: 12V - 5W Quantity: 1
----------------------	--

Stop light bulb	Type: ALL GLASS Power: 12V - 2.3 W Quantity: 8
-----------------	---

Tail light warning light bulb	Type: ALL GLASS Power: 12V - 2W Quantity: 1
-------------------------------	--

High-beam warning light bulb	Type: ALL GLASS Power: 12V - 1.2W Quantity: 1
------------------------------	--

Low fuel warning light bulb	Type: ALL GLASS Power: 12V - 1.2W Quantity: 1
-----------------------------	--

Oil pressure warning light bulb	Type: ALL GLASS Power: 12V - 1.2W
---------------------------------	--

Quantity: 1

(Right and left) turn indicator
warning light bulbs

Type: ALL GLASS

Power: 12V - 2W

Quantity: 2

Panel lighting bulb

Type: ALL GLASS

Power: 12V - 1.2W

Quantity: 1



Front light group (03_25, 03_26, 03_27, 03_28, 03_29)

To remove the front headlight assembly, proceed as follows:

- 1: remove rear-view mirrors.
- 2: Remove the screws «A» of the front shield grille.
- 3: Remove the fixing screws «B» of the front handlebar cover.
- 4: Remove the fixing screws «C» of the rear handlebar cover
- 5: Remove the front handlebar cover.

So there is access to the bulbs. Open the clip and take out the high-/low-beam light bulb «D». To change the tail light take out the rubber light socket from the seat. To reassemble, repeat the operation in the reverse order.

WARNING

THE TWIN-FILAMENT (HIGH-BEAM AND LOW-BEAM) BULB IS HALOGEN: DO NOT TOUCH THE BULB WITH YOUR FINGERS TO AVOID COMPROMISING ITS FUNCTIONING

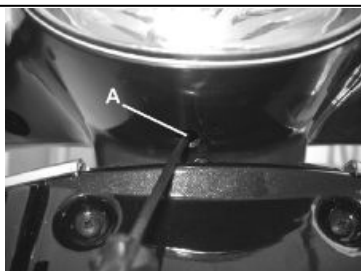

03_26



03_27



03_28

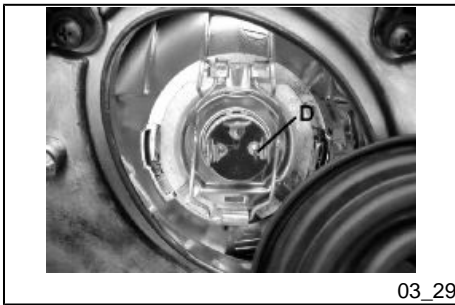

03_29



03_30

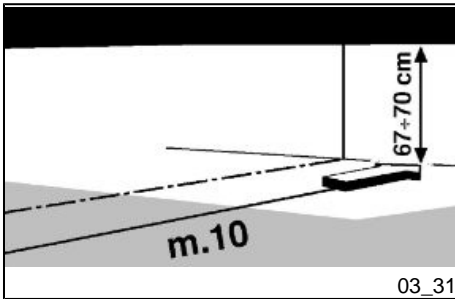

03_31

Headlight adjustment (03_30, 03_31)

Proceed as follows:

1. position the unloaded scooter, in running order and with the tyres inflated to the prescribed pressure, onto a flat surface 10 m away from a half-lift white screen; ensure the longitudinal axis of the scooter is perpendicular to the screen;
2. draw a horizontal line on the screen at a height of 67 ÷ 70 cm from the ground;
3. switch on the headlight at low beam and check that the horizontal borderline of the projected light beam between the dark and light area is not higher than the horizontal line drawn on the screen;
4. otherwise, regulate the headlight by adjusting the screw «A», after removing the front grille.

Front direction indicators (03_32)

To replace the burnt bulb, remove the screws «F»

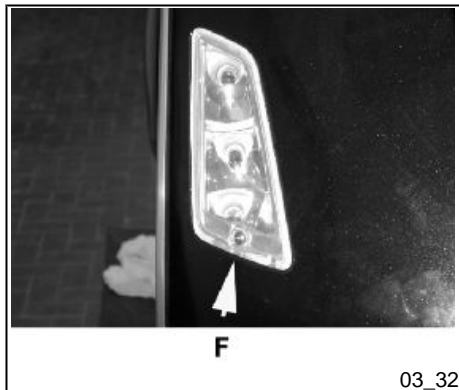

Rear optical unit (03_33, 03_34, 03_35)

To remove the rear light assembly, proceed as follows:

- 1: Remove the two screws «A» and remove the plastic cover «B»
- 2: remove the screws «D» and remove the rear light assembly from its seat.
- 3: So there is access to the rear taillight bulbs and the stop light bulb.

To reassemble, repeat the operation in the reverse order.

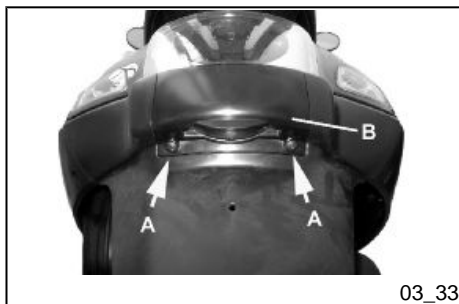

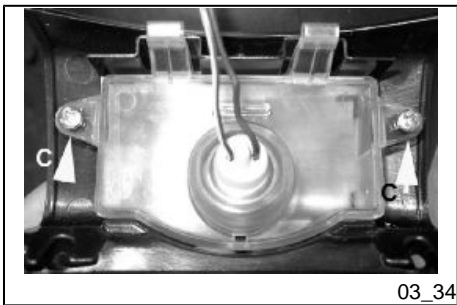

Rear turn indicators (03_36)

To replace the rear turn indicator bulb proceed as follows:
remove the screws «E» and take out the transparent license plate holder.

Now replace the bulb.

Number plate light (03_37, 03_38)

To remove the license plate holder bulb proceed as follows:

- 1: Remove the two screws «A» and remove the plastic cover «B»
- 2: remove the two screws «C» to take out the plastic bulb holder and then remove the license plate bulb.

To reassemble, repeat the operation in the reverse order.

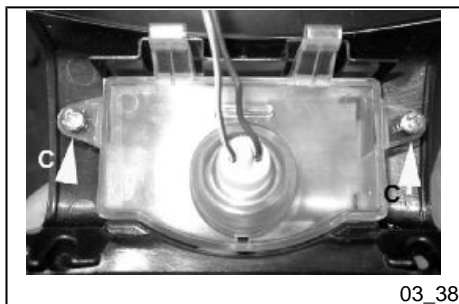
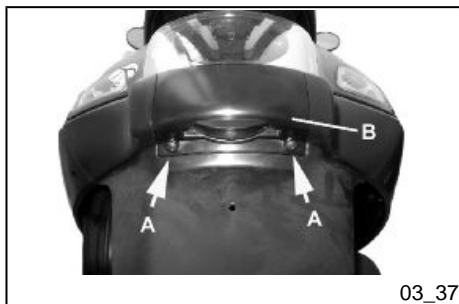

Rear-view mirrors

Adjust the mirrors by applying slight pressure to the side of the mirror to move it to the desired position.

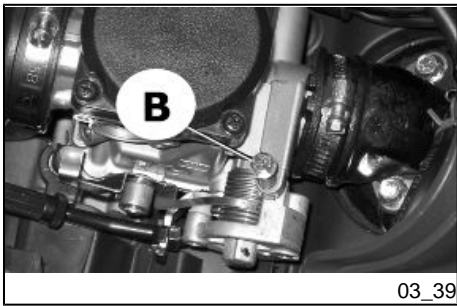

03_39

Idle adjustment (03_39)

Proceed as follows:

1. rest the vehicle on its stand, lift the saddle and remove the helmet compartment.
2. to adjust idle speed, start the engine, then tighten or loosen the screw «B» until you reach the recommended idle speed making sure the engine does not make the rear wheel move.

If adjustment is difficult, take the vehicle to an **Authorised Piaggio Service Centre or Dealer**.

WARNING



IDLE SPEED MUST BE ADJUSTED WHEN THE ENGINE IS VERY HOT. BEFORE THIS OPERATION, MAKE SURE THAT THE THROTTLE GRIP HAS THE RECOMMENDED BACKLASH. IF BACKLASH IN THE THROTTLE CONTROL TRANSMISSION NEEDS ADJUSTING TAKE YOUR SCOOTER TO AN AUTHORISED DEALER OR SERVICE CENTRE.

Characteristic

Idle speed adjustment

about 1650±100 rpm

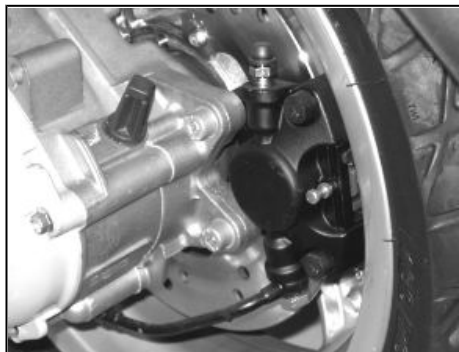

03_40

Front and rear disc brake (03_40, 03_41)

The brake disc and pad wear is automatically compensated, therefore it has no effect on the functioning of the front and rear brakes. For this reason it is not necessary to adjust the brakes. An excessively elastic brake lever stroke may indicate the presence of air in the braking circuit or a failure in the braking system. In this case, mainly due to the importance of brakes to guarantee safe riding conditions, the vehicle should be taken to an **Authorised Service Centre or Dealer**.

CAUTION



BRAKING SHOULD BEGIN AFTER ABOUT 1/3 OF THE BRAKE LEVER STROKE.

CAUTION



HAVE THE BRAKE PADS CHECKED BY THE DEALER ACCORDING TO THE CHECKS SPECIFIED IN THE SCHEDULED MAINTENANCE TABLE. HOWEVER, IN THE EVENT OF NOISES COMING FROM THE FRONT AND/OR REAR BRAKING SYSTEM DURING OPERATION, IT IS ADVISABLE TO HAVE THE BRAKING SYSTEM CHECKED BY AN AUTHORISED SERVICE CENTRE OR DEALER. AFTER REPLACING THE BRAKE PADS, DO NOT USE THE SCOOTER UNTIL YOU HAVE OPERATED THE BRAKE LEVER SEVERAL TIMES IN ORDER TO ALLOW THE PLUNGERS TO SETTLE AND THE LEVER STROKE TO BE SET TO THE CORRECT POSITION.

CAUTION



THE PRESENCE OF SAND, MUD, SNOW MIXED WITH SALT, ETC. ON THE ROAD, CAN DRASTICALLY REDUCE THE LIFE OF THE BRAKE PADS. IN ORDER TO AVOID THIS, WE RECOMMEND WASHING THE VEHICLE FREQUENTLY WHEN RIDING IN THESE ROAD CONDITIONS.



03_41

Puncture

The vehicle is equipped with Tubeless tyres (without inner tube). In the event of a puncture, Tubeless tyres - unlike tyres with inner tubes - go flat very slowly, resulting in a greater steering safety. In the event of a puncture, an emergency repair can be carried out using an "inflate and repair" spray can. For a final repair, take your vehicle to an **Authorised Service Centre or Dealer**. The replacement of a tyre involves removing the wheel in question. Take your vehicle to an **Authorised Service Centre or Dealer** for these operations.

CAUTION



TO USE THE "INFLATE AND REPAIR" SPRAY CAN PROPERLY, FOLLOW THE INSTRUCTIONS ON THE PACKAGING.

WARNING



THE WHEELS FITTED WITH TYRES SHOULD ALWAYS BE BALANCED. RIDING THE VEHICLE WITH VERY LOW TYRE PRESSURE OR WITH INCORRECTLY BALANCED TYRES CAN LEAD TO DANGEROUS STEERING VIBRATIONS.



03_42

Periods of inactivity (03_42)

We recommend carrying out the following operations:

1. Clean the scooter thoroughly and then cover it with a canvas;
2. With engine off and piston at the bottom dead centre, remove the spark plug, fill with 1÷2 cc oil (larger amounts are dangerous for the engine itself). Operate the starter button 1-2 times for roughly 1 second to turn the engine over slowly, then insert the spark plug again;
3. Drain all the fuel from the scooter; spread antirust grease on the unpainted metal parts; keep the wheels lifted above the ground by resting the chassis on two wooden wedges;
4. As regards the battery, follow the instructions in the "Battery" section.

Recommended products

AGIP CITY HI TEC 4T

Oil to lubricate flexible transmissions (throttle control)

Oil for 4-stroke engines

Cleaning the vehicle

Use a low pressure water jet in order to soften the dirt and mud deposited on painted surfaces. Once softened, mud and dirt must be removed with a soft sponge for body-work soaked with water and shampoo (2-4% of shampoo in water). Then rinse abundantly with water, and dry with a shammy cloth. Any polishing with silicon wax must always be preceded by washing

CAUTION



DETERGENTS CAN POLLUTE WATER. THE VEHICLE MUST BE WASHED AT A WASH STATION EQUIPPED WITH A SPECIAL WATER PURIFICATION SYSTEM.

WARNING

THE USE OF A HIGH-PRESSURE WATER JET IS STRONGLY DISCOURAGED FOR ANY ENGINE CLEANING OPERATION; HOWEVER, IF NO OTHER MEANS ARE AVAILABLE, IT IS THEN NECESSARY TO:

- **ONLY USE A FANLIKE SPRAY JET.**
- **DO NOT PLACE THE NOZZLE CLOSER THAN 60 CM.**
- **DO NOT USE WATER AT TEMPERATURES OVER 40°C.**
- **DO NOT USE HIGH-PRESSURE WATER JETS.**
- **DO NOT STEAM WASH.**
- **DO NOT AIM THE JET DIRECTLY AT: THE CARBURETTOR, THE ELECTRIC CABLES, THE SLOT DIFFUSERS IN THE TRANSMISSION COVER AND THE SCROLL COVER.**

WARNING

NEVER WASH THE SCOOTER IN DIRECT SUNLIGHT, ESPECIALLY DURING SUMMER WHEN THE BODYWORK IS STILL HOT, AS THE SHAMPOO CAN DAMAGE THE PAINTWORK IF IT DRIES BEFORE BEING RINSED OFF. NEVER USE CLOTHS SOAKED IN PETROL, DIESEL OIL OR KEROSENE FOR CLEANING THE PAINTED OR PLASTIC SURFACES SO AS NOT TO DAMAGE THE LUSTRE FINISH OR ALTER THE MECHANICAL PROPERTIES.

DIFFICULT STARTING

No fuel in tank	Refuel
Filters, carburettor jets dirty or clogged, fuel filter, fuel pipes clogged, fuel pump damaged	Contact an Authorised Piaggio Service Centre
Battery flat	Recharge the battery.

IGNITION PROBLEMS

No spark from spark plug. Due to the presence of high voltage, this element should only be checked by an expert.	Contact an Authorised Piaggio Service Centre
--	---

LACK OF COMPRESSION

Spark plug loose. Loose cylinder head, worn piston retaining rings.	Screw the spark plug.
Incorrect valve clearance	Contact an Authorised Piaggio Service Centre

HIGH CONSUMPTION AND LOW PERFORMANCE

Air filter blocked or dirty.	Clean with water and shampoo and impregnate with petrol and specific oil («Air filter removal» section)
------------------------------	---

INSUFFICIENT BRAKING

Greasy disc. Worn pads	Contact an Authorised Piaggio Service Centre
Air in the front and rear brake circuits	Contact an Authorised Piaggio Service Centre

INEFFICIENT SUSPENSIONS

Inefficient shock absorbers, oil leakage, deteriorated end of stroke buffers.	Contact an Authorised Service Centre
---	---

AUTOMATIC TRANSMISSION PROBLEMS

Deteriorated variable speed rollers and/or driving belt and/or clutch	Contact an Authorised Service Centre
---	---

EXHAUST NOISE

Depression tube damaged/
disconnected or secondary valve
damaged

Contact an **Authorised Service
Centre**

Vespa GT 125 Euro 3

Vespa®



Chap. 04
Technical data

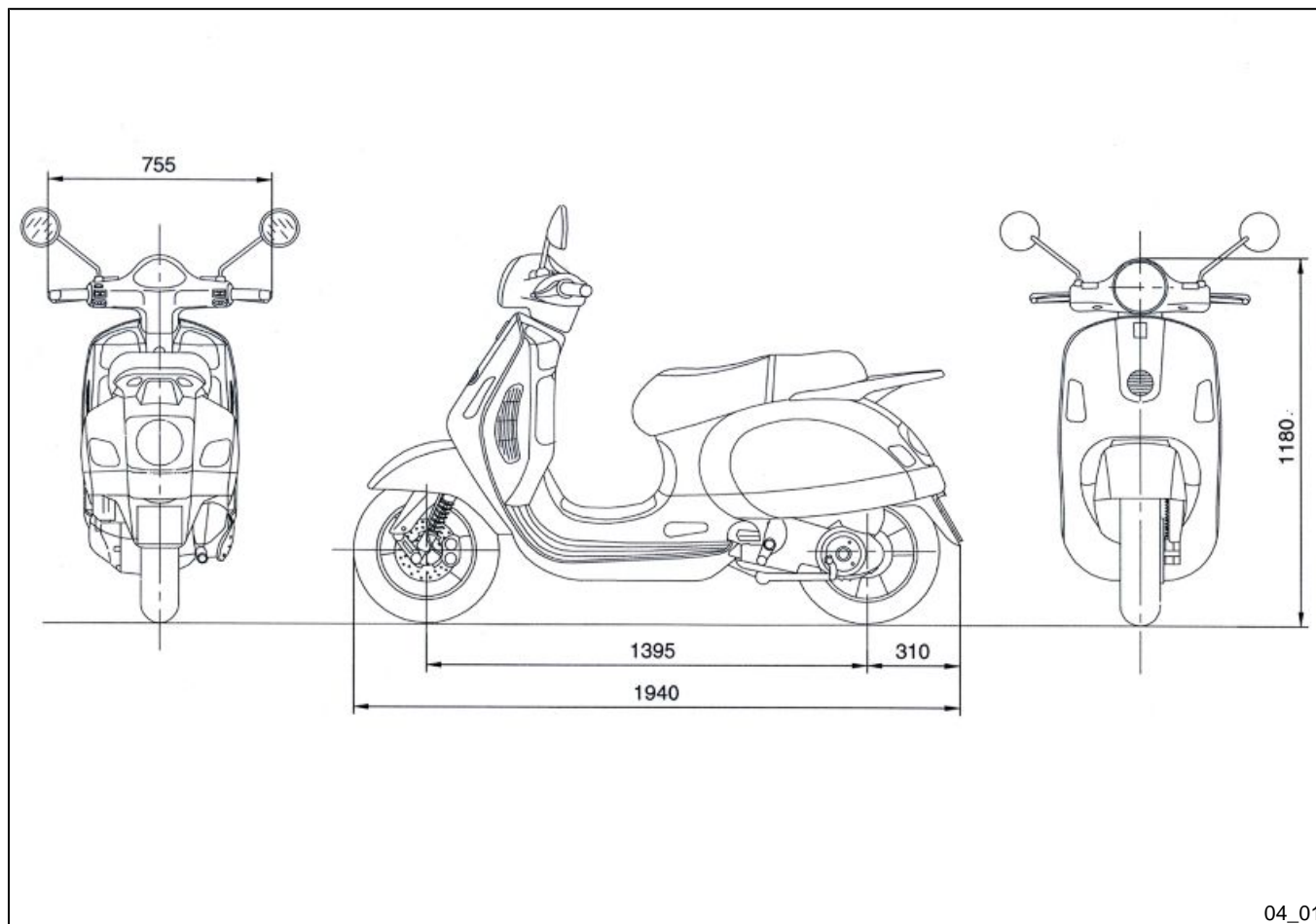

TECHNICAL DATA

Engine	single-cylinder, four-stroke
Bore x stroke	57 x 48.6 mm
Cubic capacity	124 cm ³
Compression ratio	11.5 ÷ 12.5 :1
Ignition/advance	Electronic, with inductive discharge and variable advance with three-dimensional mapping
Carburettor KEIHIN	CVK30
Spark plug	CHAMPION RG4HC
Max speed	102 km/h
Valve clearance	intake: 0.10 mm discharge: 0.15 mm
Overall length	1940 mm
Overall width	755 mm
Overall height	1180 mm
Wheelbase	1395 mm
Fuel supply	Unleaded petrol; carburettor and electrical pump.
Exhaust muffler	Absorption-type exhaust muffler with catalytic converter.
Electronic ignition	capacitative, with variable timing and separate HV coil

Lubrication	Engine lubrication with lobe pump (inside crankcase), chain-driven, with double filter: mesh and paper.
Start-up	Electric
Cooling	Forced liquid circulation cooling.
Transmission	Automatic expandable pulley variator with torque server, V belt, automatic centrifugal dry clutch, gear reduction unit and transmission compartment with forced air circulation cooling.
Front brake	Ø 220 disc brake with hydraulic control activated by handlebar right lever.
Rear brake	disc brake, diameter 220 mm, with hydraulic servo operated from the handlebar with the left-hand lever.
Front wheel	Alloy rims: 12" x 3.00"
Rear wheel	Alloy rims: 12" x 3.00"
Front tyre	Without inner tube 120/70-12" 51P
Rear tyre	Without inner tube: 130/70-12" 62P
Front suspension	Single arm suspension (cantilever wheel) fitted with a dual-chamber hydraulic shock absorber with coaxial spring.
Rear suspension	single arm with two double-acting hydraulic shock absorbers and preloading adjustment in 4 positions.
Chassis	Stamped plate supporting body.

dry weight	140 kg.
Maximum admitted weight	~ 340 kg
Fuel tank capacity	About 10 l
Fuel reserve	~ 2.0 l (approximate value)
Engine oil	Capacity: 1.1 l (dry) ; 1.0 l (when changing oil and filter)
rear hub oil capacity	Capacity: approx. 150 cm ³
Cooling system	Capacity: ~ 2.100 ÷ 2.150 l



04_02

Kit equipment (04_02)

One box-spanner for spark plugs; one twin screwdriver; one special spanner for adjusting the rear shock absorber. The tools are arranged in the front case.

Vespa GT 125 Euro 3

Vespa®



Chap. 05
Spare parts and
accessories



05_01

Warnings (05_01)

WARNING



TO PREVENT ACCIDENTS AND TO GUARANTEE PROPER STABILITY, PERFORMANCE AND SAFETY, RIDE THE VEHICLE VERY CAREFULLY WHEN IT IS FITTED WITH ACCESSORIES OR WITH UNUSUAL LOADS.

WARNING



IT IS ALSO RECOMMENDED THAT ORIGINAL PIAGGIO SPARE PARTS BE USED, AS THESE ARE THE ONLY ONES OFFERING YOU THE SAME QUALITY GUARANTEE AS THOSE INITIALLY FITTED ON THE SCOOTER. THE USE OF NON-ORIGINAL SPARE PARTS RENDERS THE WARRANTY VOID.

WARNING



PIAGGIO MARKETS ITS OWN LINE OF ACCESSORIES THAT ARE RECOGNISED AND GUARANTEED FOR USE. IT IS THEREFORE ESSENTIAL TO CONTACT AN AUTHORISED DEALER OR SERVICE CENTRE IN ORDER TO CHOOSE AND FIT ACCESSORIES CORRECTLY. THE USE OF NON-ORIGINAL ACCESSORIES MAY AFFECT THE STABILITY AND OPERATION OF YOUR VEHICLE AND REDUCE SAFETY LEVELS WITH POTENTIAL RISKS FOR THE RIDER.

WARNING

NEVER RIDE THE SCOOTER EQUIPPED WITH ACCESSORIES (TOP BOX AND/OR WINDSHIELD) AT A SPEED HIGHER THAN 100 km/h.

THE SCOOTER CAN BE RIDDEN AT A HIGHER SPEED WITHOUT THE ACCESSORIES MENTIONED BEFORE WITHIN THE LIMITS ESTABLISHED BY LAW.

IF THERE ARE ANY NON-PIAGGIO ACCESSORIES INSTALLED, OR AN ABNORMAL LOAD, OR IF THE SCOOTER IS NOT IN A GENERALLY GOOD CONDITION, OR WHENEVER WEATHER CONDITIONS DEMAND IT, SPEED SHOULD BE FURTHER REDUCED.

WARNING

BE EXTREMELY CAREFUL WHEN INSTALLING AND REMOVING THE MECHANICAL ANTITHEFT DEVICE ON THE VEHICLE (U-SHAPED PADLOCK, DISC BLOCK, ETC.).

MAINLY NEAR THE BRAKE PIPES, TRANSMISSIONS AND/OR ELECTRIC CABLES, AN INCORRECT INSTALLATION OR REMOVAL OF THE ANTITHEFT DEVICE AS WELL AS LEAVING IT ON BEFORE STARTING THE VEHICLE CAN SERIOUSLY DAMAGE ITS COMPONENTS, COMPROMISE THE CORRECT FUNCTIONING OF THE VEHICLE AND USERS' SAFETY.

Vespa GT 125 Euro 3

Vespa®



**Chap. 06
Programmed
maintenance**

Scheduled maintenance table

Adequate maintenance is fundamental to ensure long-lasting, optimum operation and performance of your vehicle.

To this end, a series of checks and maintenance operations (at the owner's expense) have been suggested, which are included in the summary table on the following page. Any minor faults should be reported without delay to an **Authorised Service Centre or Dealer** without waiting until the next scheduled service to solve it.

All scheduled maintenance services must be carried out at the specified intervals, even if the stated mileage has not yet been reached. Punctual scooter servicing is essential to ensure your warranty remains valid. For any further information concerning Warranty procedures and 'Scheduled Maintenance', please refer to the 'Warranty Booklet'.

AFTER 1000 KM

Engine oil - replacement

Hub oil - change

Engine oil - change

Idle speed (*) - adjustment

Throttle lever - adjustment

Steering - adjustment

Brake control levers - greasing

Brake pads - check condition and wear

Brake fluid level - check

Safety locks - check

Electrical system and battery - check

Tyre pressure and wear - check

Vehicle and brake test - road test

(*) See instructions in «Idle speed adjustment» section

EVERY 3,000 KM

Engine oil - level check/ top-up

AFTER 6000 KM

Engine oil - replacement

Hub oil level - check

Spark plug/ electrode gap - check

Air filter - clean

Engine oil - change

valve clearance - check

Variable speed rollers - check or replacement

Driving belt - checking

Coolant level - check

Brake pads - check condition and wear

Brake fluid level - check

Electrical system and battery - check

Tyre pressure and wear - check

Vehicle and brake test - road test

AFTER 12,000 KM; 60,000 KM

Engine oil - replacement

Hub oil level - check

Air filter - clean

Engine oil - change

Spark plug - replacement

Idle speed (*) - adjustment

Throttle lever - adjustment

Driven pulley roller casing - Greasing

Driving belt - replacement

Sliding blocks / variable speed rollers - check

Coolant level - check

Steering - adjustment

Brake control levers - greasing

Brake pads - check condition and wear

Brake fluid level - check

Transmission elements - lubrication

Safety locks - check

Suspensions - check

Electrical system and battery - check

Headlight - adjustment

Tyre pressure and wear - check

Vehicle and brake test - road test

() See instructions in the «Idle speed adjustment» section*

AT 18000 KM AND AT 54000 KM

Engine oil - replacement

Hub oil level - check

Spark plug/ electrode gap - check

Air filter - clean

Engine oil - change

Variable speed rollers - check or replacement

Driving belt - checking

Coolant level - check

Radiator - external cleaning/ check

Brake pads - check condition and wear

Brake fluid level - check

Electrical system and battery - check

Tyre pressure and wear - check

Vehicle and brake test - road test

AT 24000 KM AND AT 48000 KM

Engine oil - replacement

Hub oil - change

Air filter - clean

Engine oil - change

Spark plug - replacement

valve clearance - check

Idle speed (*) - adjustment

Throttle lever - adjustment

Variable speed rollers - check or replacement

Driving belt - replacement

Coolant level - check

Steering - adjustment

Brake control levers - greasing

Brake pads - check condition and wear

Brake fluid level - check

Transmission elements - lubrication

Safety locks - check

Suspensions - check

Electrical system and battery - check

Headlight - adjustment

Driven pulley roller casing - Greasing
--

Tyre pressure and wear - check

Vehicle and brake test - road test

(*) See instructions in «Idle speed adjustment» section

AT 30000 KM, AT 42000 KM AND AT 66000 KM

Hub oil level - check

Spark plug/ electrode gap - check

Air filter - clean

Variable speed rollers - check or replacement

Driving belt - checking

Coolant level - check

Brake pads - check condition and wear

Brake fluid level - check

Electrical system and battery - check

Tyre pressure and wear - check

Vehicle and brake test - road test

Engine oil - replacement

Oil filter -Replacement

AFTER 36000 KM

Engine oil - replacement

Hub oil level - check

Air filter - clean

Engine oil - change

Spark plug - replacement

Idle speed (*) - adjustment

Throttle lever - adjustment

Variable speed rollers - check or replacement

Driving belt - replacement

Coolant level - check

Radiator - external cleaning/ check

Steering - adjustment

Brake control levers - greasing

Brake pads - check condition and wear

Brake fluid hoses - replacement

Brake fluid level - check

Transmission elements - lubrication

Safety locks - check

Suspensions - check

Electrical system and battery - check

Headlight - adjustment

Driven pulley roller casing - Greasing

Tyre pressure and wear - check

Vehicle and brake test - road test

() See instructions in «Idle speed adjustment» section*

AFTER 72000 KM

Engine oil - replacement

Hub oil - change

Spark plug / electrode gap - check / replacement

Air filter - clean

Engine oil - change

valve clearance - check

Idle speed (*) - adjustment

Throttle lever - adjustment

Variable speed rollers - check or replacement

Driving belt - replacement

Coolant level - check

Radiator - external cleaning/ check

Steering - adjustment

Brake control levers - greasing

Brake pads - check condition and wear

Brake fluid hoses - replacement

Brake fluid level - check

Transmission elements - lubrication

Safety locks - check

Suspensions - check

Electrical system and battery - check

Headlight - adjustment

Driven pulley roller casing - Greasing
--

Tyre pressure and wear - check

Vehicle and brake test - road test

(*) See instructions in «Idle speed adjustment» section

EVERY 2 YEARS

Coolant - change

Brake fluid - change

Secondary air filter (external / internal) - Clean
--

RECOMMENDED PRODUCTS TABLE

Product	Description	Specifications
AGIP ROTRA 80W-90	Rear hub oil	SAE 80W/90 Oil that exceeds the requirements of API GL3 specifications
AGIP CITY HI TEC 4T	Oil to lubricate flexible transmissions (throttle control)	Oil for 4-stroke engines
AGIP FILTER OIL	Oil for air filter sponge	Mineral oil with specific additives for increased adhesiveness
AGIP GP 330	Calcium complex soap-based grease with NLGI 2; ISO-L-XBCIB2	Grease (brake control levers, throttle grip)
AGIP CITY HI TEC 4T	Engine oil	SAE 5W-40, API SL, ACEA A3, JASO MA Synthetic oil
AGIP BRAKE 4	Brake fluid	FMVSS DOT 4 Synthetic fluid
SPECIAL AGIP PERMANENT fluid	coolant	Monoethylene glycol-based antifreeze fluid, CUNA NC 956-16

TABLE OF CONTENTS

A

Air filter: 41

B

Battery: 46, 47

Brake: 45, 61

C

Clock: 9

D

Disc brake: 61

E

Engine oil: 34–36

Engine stop: 12

F

Fuel: 16

Fuses: 49

H

Headlight: 56

Horn: 11

Hub oil: 37

I

Identification: 18

Immobilizer: 12, 15

Instrument panel: 8

K

Key switch: 9

Keys: 13

L

Light switch: 11

M

Maintenance: 33, 79, 80

Mirrors: 59

S

Saddle: 17

Scheduled maintenance: 80

Shock absorbers: 25

Spark plug: 40

Stand: 29

Start-up: 12

T

Tank: 16

Technical Data: 69

Top box: 19

Transmission: 29

Turn indicators: 58

Tyre pressure: 24

Tyres: 39



The descriptions and illustrations given in this publication are not binding. While the basic specifications as described and illustrated in this booklet remain unchanged, PIAGGIO-GILERA reserves the right, at any time and without being required to update this publication beforehand, to make any changes to components, parts or accessories, which it considers necessary to improve the product or which are required for manufacturing or construction reasons.

Not all versions/models shown in this publication are available in all countries. The availability of single models should be checked at the official Piaggio sales network.

"© Copyright 2008 - PIAGGIO & C. S.p.A. Pontedera. All rights reserved. Reproduction of this publication in whole or in part is prohibited."

PIAGGIO & C. S.p.A. - After-Sales

V.le Rinaldo Piaggio, 23 - 56025 PONTEDERA (Pi)