

Vespa would like to thank you

for choosing one of its products. We have prepared this booklet to help you to get the very best from your scooter. Please read it carefully before riding the vehicle for the first time. It contains information, tips and precautions for using your vehicle. It also describes features, details and devices to assure you that you have made the right choice. We believe that if you follow our suggestions, you will soon get to know your new vehicle and use it for a long time at full satisfaction. This booklet forms an integral part of the vehicle; should the vehicle be sold, it must be transferred to the new owner.

## Vespa GTS 125



The instructions given in this booklet are intended to provide a clear, simple guide to using your scooter; details are also given of routine maintenance procedures and regular checks that should be carried out on the vehicle at an **Authorised PIAGGIO Dealer or Service Centre**. The booklet also contains instructions for simple repairs. Any operations not specifically described in this booklet require the use of special tools and/or particular technical knowledge: to carry out these operations refer to any **authorised PIAGGIO Dealer or Service Centre**.



### **Personal safety**

Failure to completely observe these instructions will result in serious risk of personal injury.



### **Safeguarding the environment**

Sections marked with this symbol indicate the correct use of the vehicle to prevent damaging the environment.



### **Vehicle intactness**

The incomplete or non-observance of these regulations leads to the risk of serious damage to the vehicle and sometimes even the invalidity of the guarantee.

*The signs that you see on this page are very important. They are used to highlight those parts of the booklet that should be read with particular care. As you can see, each sign consists of a different graphic symbol, making it quick and easy to locate the various topics.*



# INDEX

<b>VEHICLE</b> .....	7	Safe driving.....	30
Dashboard.....	8	Rear rack.....	32
Analogue instrument panel.....	8	<b>MAINTENANCE</b> .....	33
Clock.....	9	Engine oil level.....	34
Key switch.....	9	Engine oil level check.....	35
Locking the steering wheel.....	10	Engine oil top-up.....	35
Releasing the steering wheel.....	10	Warning light (insufficient oil pressure).....	35
Switch direction indicators.....	10	Engine oil change.....	36
Horn button.....	11	Hub oil level.....	37
Light switch.....	11	Tyres.....	39
Start-up button.....	12	Spark plug dismantlement.....	40
Engine stop button.....	12	Removing the air filter.....	41
The immobilizer system.....	12	Secondary air system.....	42
Keys.....	13	Cooling fluid level.....	43
Immobilizer device enabled indicator led.....	14	Checking the brake oil level.....	45
Operation.....	14	Battery.....	46
Programming the immobilizer system.....	15	Use of a new battery.....	47
Accessing the fuel tank.....	16	Long periods of inactivity.....	48
Opening the saddle.....	17	Fuses.....	49
Identification.....	18	Front light group.....	54
Rear top box opening.....	19	Headlight adjustment.....	55
<b>USE</b> .....	21	Front direction indicators.....	56
Checks.....	22	Rear optical unit.....	57
Refuelling.....	22	Rear turn indicators.....	57
Tyre pressure.....	24	Rear-view mirrors.....	58
Shock absorbers adjustment.....	25	Idle adjustment.....	58
Running in.....	26	Front and rear disc brake.....	59
Starting up the engine.....	26	Puncture.....	60
Precautions.....	27	Periods of inactivity.....	61
Difficult start up.....	28	Cleaning the vehicle.....	61
Stopping the engine.....	28	<b>TECHNICAL DATA</b> .....	67
Stand.....	29	Kit equipment.....	71
Automatic transmission.....	29	<b>SPARE PARTS AND ACCESSORIES</b> .....	73

Warnings.....	74
<b>PROGRAMMED MAINTENANCE.....</b>	<b>77</b>
Scheduled maintenance table.....	78

**Vespa GTS 125**

**Vespa®**



**Chap. 01  
Vehicle**

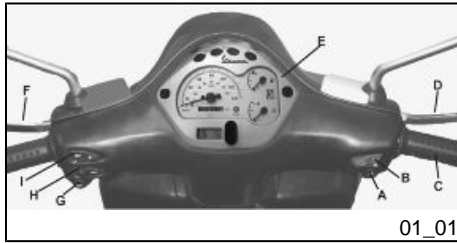

### Dashboard (01\_01)

- A = Starter button
- B = Engine block Run-Off switch
- C = Throttle control
- D = Front brake lever
- E = Instrument panel
- F = Rear brake control lever
- G = Horn button
- H = Turn indicator switch
- I = Light switch

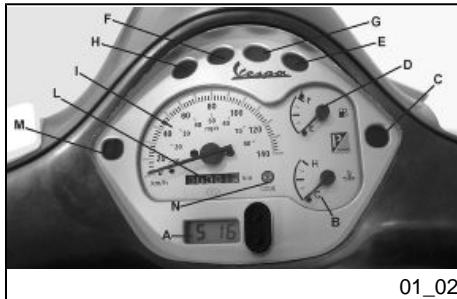

### Analogue instrument panel (01\_02)

- A = Digital clock with calendar
- B = Cooling liquid temperature gauge
- C = Right turn indicator warning light
- D = Fuel gauge
- E = Headlight warning light
- F = Low oil pressure warning light
- G = High-beam warning light
- H = Low fuel warning light
- I = Speedometer
- L = Odometer



**M** = Left turn indicator warning light

**N** = Antitheft device led (immobilizer)

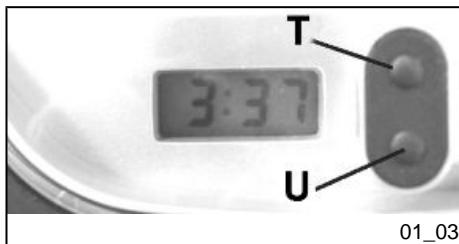

01\_03

### Clock (01\_03)

Hours and minutes are displayed in a 1 to 12, AM or PM, format on the instrument panel.

Operating the function selection switch «**T**» month, day and seconds can be seen besides hours and minutes. In order to adjust the above mentioned functions, operate button «**U**». The digital clock is powered by a battery (battery life is about 2 years); lift the whole instrument panel to replace the battery. It is advisable to take your vehicle to an **Authorised Service Centre** for this operation.

#### WARNING



**DEAD BATTERIES ARE HARMFUL TO THE ENVIRONMENT. THEY MUST DISPOSED OF IN SUITABLE CONTAINERS AS PRESCRIBED BY THE REGULATIONS IN FORCE.**

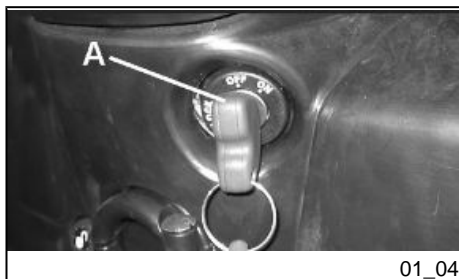

01\_04

### Key switch (01\_04)

**LOCK** = ignition disabled, extractable key, mechanical antitheft device enabled.

**OFF** = ignition disabled, extractable key, mechanical antitheft device disabled.

**ON** = Ready to ignition position, non-extractable key, mechanical antitheft device disabled, lights on.

## Locking the steering wheel

Turn the handlebar to the left (as far as it will go), turn the key to «**LOCK**» and remove the key.

### CAUTION



**DO NOT TURN THE KEY TO «LOCK» OR «KEY OFF» WHILE RIDING.**

## Releasing the steering wheel

Reinsert the key and turn it to «**OFF**».

### CAUTION



**DO NOT TURN THE KEY TO «LOCK» OR «KEY OFF» WHILE RIDING.**

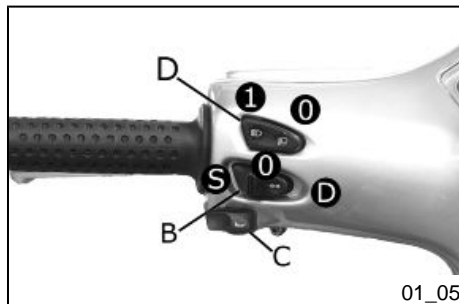

## Switch direction indicators (01\_05)

Lever towards "S" = Left turn indicator is switched on;

Lever towards "D" = Right turn indicator is switched on;

The lever returns automatically to position "0" and the turn indicator "B" remains on; press the lever to turn them off.

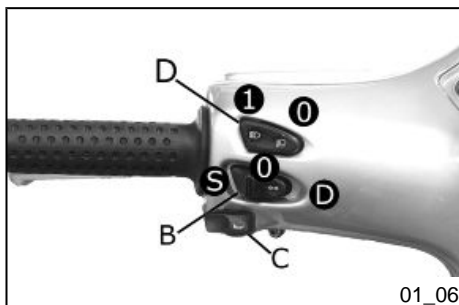

### Horn button (01\_06)

Push the «C» button to sound the horn.

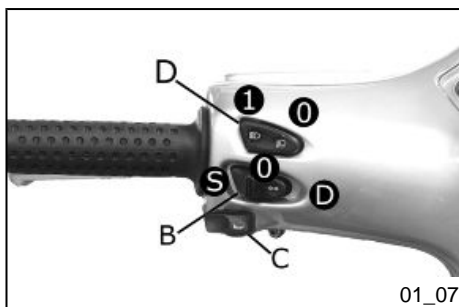

### Light switch (01\_07)

0 = Low-beam and tail light

1 = High-beam and tail light

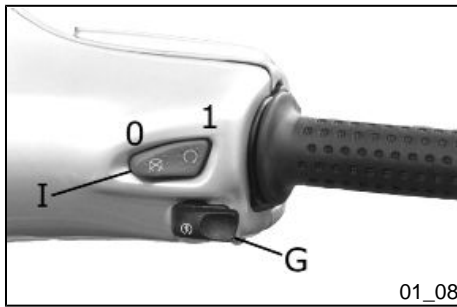

### Start-up button (01\_08)

Starter button "G"

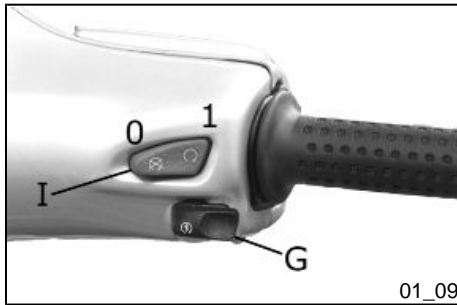

### Engine stop button (01\_09)

0 = OFF

1 = RUN

### The immobilizer system

In order to enhance theft protection, the vehicle is equipped with a «**PIAGGIO IMMOBILIZER**» electronic engine locking device that is activated automatically when the starter key is removed. Upon start-up, the «**PIAGGIO IMMOBILIZER**» system checks the starter key, and only if this key is recognised will the immobilizer system allow the vehicle to be started.

## Keys (01\_10, 01\_11, 01\_12)

The vehicle is supplied with two types of keys. The red-handgrip key «A» is the "MASTER" key. Only a single copy of this key is supplied, which is necessary to program all your other keys and for your dealer to perform some maintenance operations. We therefore recommend that it be used only under exceptional circumstances. The black key «B» (single copy supplied) is used for normal operations and for start-up.

Together with the keys comes a CODE CARD which is imprinted with the mechanical code of the keys.

### WARNING



**LOSING THE RED KEY PREVENTS ANY REPAIRS OF THE "PIAGGIO IMMOBILIZER" SYSTEM AND THE ENGINE CONTROL UNIT.**

### WARNING



**KEEP THE "CODE CARD" AND THE RED HANDGRIP KEY IN A SAFE PLACE (NOT ON YOUR VEHICLE).**

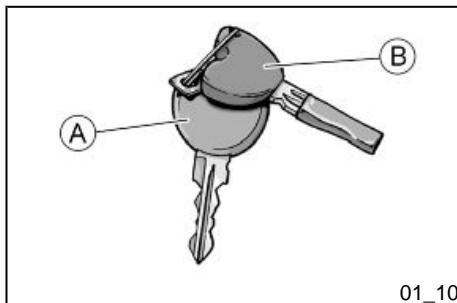

01\_10

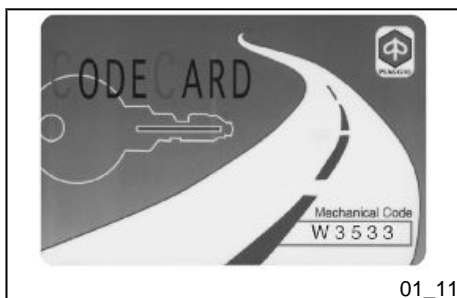

01\_11

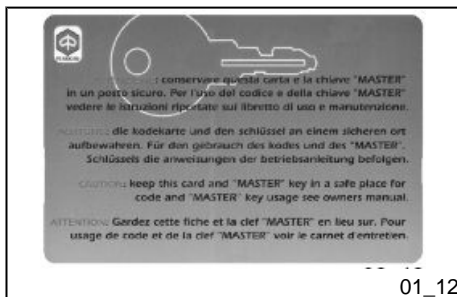

01\_12

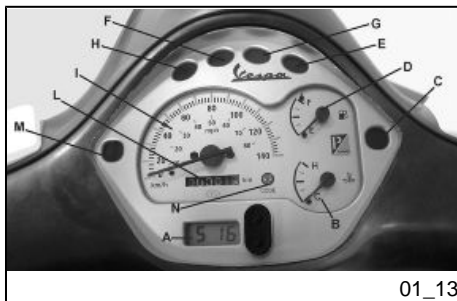

01\_13

## Immobilizerdevice enabled indicator led (01\_13)

Activation of the «**PIAGGIO IMMOBILIZER**» system is signalled by a flashing warning light «**N**» (see «Analogue instrument panel» section).

In order to reduce battery discharge, the indicator LED turns off automatically after 48 hours of uninterrupted functioning.

Should the system fail, different LED flashing patterns will be provided by an **Authorised Piaggio-Gilera Service Centre** with information on the type of fault detected.

## Operation

Every time the starter key is removed in the "**OFF**" or "**LOCK**" position, the safety system activates the immobilizer system. Turning the key to "**ON**" disables the engine lock, provided that the safety system recognises the code transmitted by the key. If the code is not recognised, turn the key first to "**OFF**" and then to "**ON**"; if the lock cannot be disabled, try with the other key supplied (red-coloured). If the engine cannot be started, contact an **Authorised Piaggio Service Centre**, which is provided with the electronic equipment required to detect and repair the system. The immobiliser is also activated in the engine is switched off with the RUN OFF switch. This happens even if the starter key is in position "**ON**".

When additional keys are required, please note that data storage (up to 3 keys max.) must be done on all keys, both new ones and existing ones. Take the key with the red grip and all the black keys supplied to an **Authorised Piaggio Service Centre**. The codes of keys not submitted for the new storage procedure are deleted from the memory. Any lost keys will therefore not be enabled to start the engine.

### WARNING



**EACH KEY HAS ITS OWN AND UNIQUE CODE, WHICH MUST BE STORED IN THE SYSTEM CONTROL UNIT MEMORY.**

**VIOLENT SHOCKS MAY AFFECT THE ELECTRONIC COMPONENTS OF THE KEY.**

**IF OWNERSHIP OF THE VEHICLE IS TRANSFERRED, THE RED HANDGRIP KEY (AS WELL AS THE OTHER KEYS) AND THE "CODE CARD" MUST ALSO BE TRANSFERRED TO THE NEW OWNER.**

## **Programming the immobilizer system**

Below is described the procedure to follow for programming the **PIAGGIO IMMOBILIZER** system and/or for storing other key codes. The programming procedure should be carried out with the engine stop switch set to «**RUN**».

### **Procedure start - red key**

Insert the red handgrip key in the switch key (in "**OFF**" position) and turn it to "**ON**". After 1 - 3 seconds, turn the key to «**OFF** » again and pull it out.

### **Intermediate step - black key**

After pulling out the red key, insert the black key within 10 seconds and promptly turn it to "**ON**". After 1-3 seconds, turn the key to "**OFF**" again and pull it out. In this way, a maximum of 3 black keys can be programmed by repeating the above procedure keeping the indicated times.

### **Final step - red key**

After pulling out the last black key, insert the red key again and turn it to "**ON**" (this operation should be performed within 10 seconds of pulling out the previous key). Leave it in this position for 1 to 3 seconds and return it to «**OFF**».

## Proper programming check

Insert the red key disabling the transponder (i.e., tilt the key cap by 90°) and turn the key to "ON". Perform the engine start-up operation. Ensure that the engine does not start. Insert the black key and repeat the start-up operation. Check that engine starts.

### WARNING

**SHOULD THE ENGINE START WITH THE RED KEY (WITH TRANSPONDER OFF), OR IN THE EVENT OF WRONG OPERATION DURING PROGRAMMING, REPEAT THE PROCEDURE FROM THE BEGINNING.**

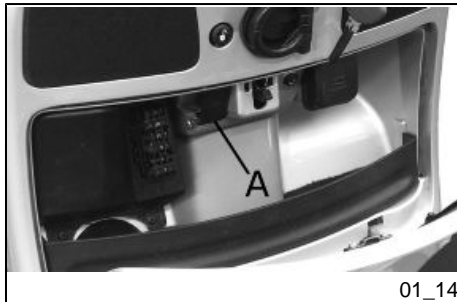

## Accessing the fuel tank (01\_14, 01\_15, 01\_16)

With the key set to «OFF» or «ON», or with engine on, it is possible to electrically open the saddle by pressing the button «C». If the saddle opening system does not work, operate the emergency lever «A». Then, unscrew cap «B» and the fuel tank can be reached.

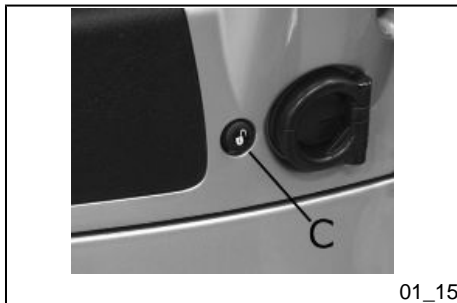



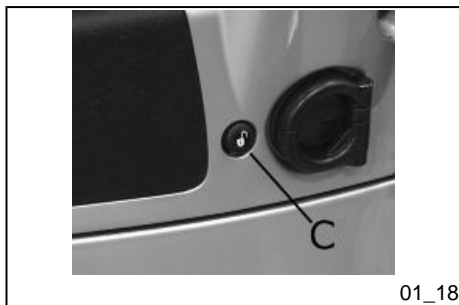
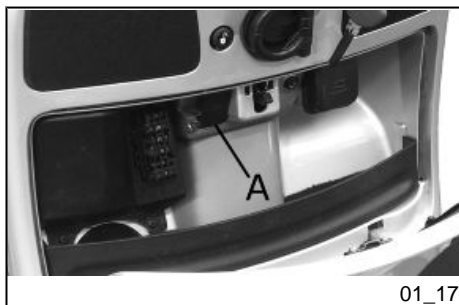
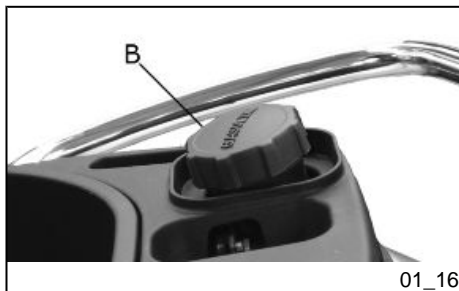

### Opening the saddle (01\_17, 01\_18)

With the key set to «OFF» or «ON», or with engine on, it is possible to electrically open the saddle by pressing button «C». If the electric opening does not work, use the emergency lever "A". When the key is set to «LOCK» the saddle cannot be opened.

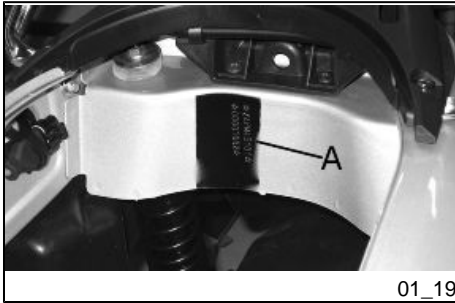

01\_19

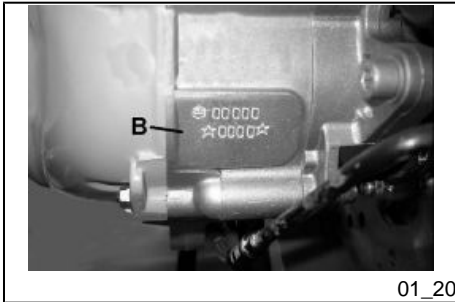

01\_20

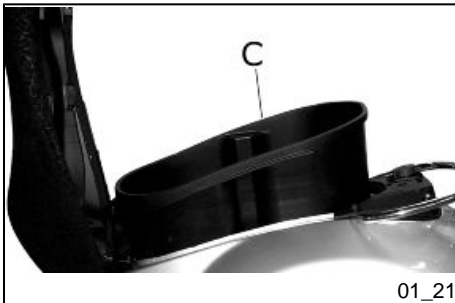

01\_21

## Identification (01\_19, 01\_20, 01\_21)

The identification registration numbers consist of a prefix followed by a number stamped on both the chassis «**A**» and the engine «**B**». These numbers must always be indicated on spare parts requests. To read the chassis number, lift the saddle and remove the helmet compartment «**C**». We recommend checking that the chassis registration number stamped on the vehicle corresponds with that on the vehicle documentation.

### CAUTION



**BE REMINDED THAT ALTERING IDENTIFICATION REGISTRATION NUMBERS CAN LEAD TO SERIOUS PENAL SANCTIONS (IMPOUNDING OF THE VEHICLE, ETC.).**

### Rear top box opening (01\_22)

Insert the key into the switch and press down until the glove compartment opens. If the switch is set to "**LOCK**", turn the key to "**OFF**" or "**ON**" before pressing it down.





# Vespa GTS 125

**Vespa®**



**Chap. 02**  
**Use**

## Checks

Before using the vehicle, check:

1. That there is enough fuel in the fuel tank.
2. That the fluid level for front and rear brakes is correct.
3. That tyres are properly inflated.
4. The correct functioning of tail lights, headlamp, turn indicators, stop light and license plate light.
5. The correct functioning of front and rear brakes.
6. The oil level in the gearcase.
7. Engine oil level.
8. The coolant level.

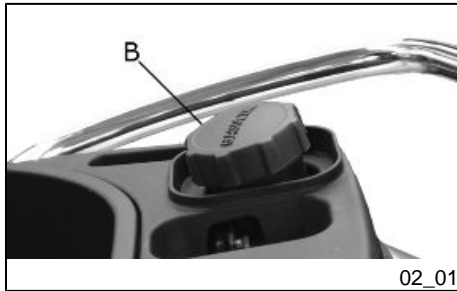

## Refuelling (02\_01, 02\_02)

Fuel: lift up the saddle and unscrew the cap «**B**». Prescribed fuel: Minimum 95 octane unleaded petrol. The warning light «**C**» indicates when the petrol tank reserve has been reached.

### WARNING



**SWITCH OFF THE ENGINE BEFORE REFUELLING WITH PETROL.**

**PETROL IS HIGHLY INFLAMMABLE.**

**DO NOT SMOKE AND KEEP NAKED FLAMES AT A DISTANCE: FIRE HAZARD.**

**DO NOT INHALE FUEL FUMES.**

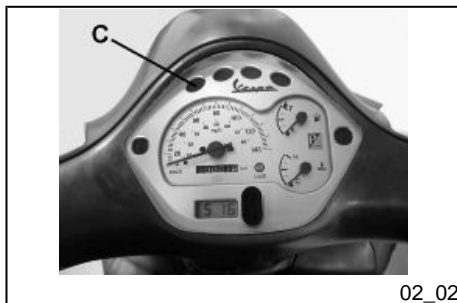

02\_02

**DO NOT ALLOW PETROL TO COME INTO CONTACT WITH HOT ENGINE OR ANY PLASTIC PARTS.**

**CAUTION**



**PETROL DAMAGES THE PLASTIC PARTS OF THE BODYWORK.**

**CAUTION**



**USING OILS OTHER THAN THOSE RECOMMENDED CAN SHORTEN THE LIFE OF THE ENGINE.**

**CAUTION**



**DO NOT USE THE VEHICLE TO THE COMPLETE EXHAUSTION OF THE FUEL; SHOULD THIS OCCUR, DO NOT ATTEMPT TO START THE ENGINE. TURN THE KEY SWITCH TO «OFF» AND TOP-UP THE TANK AS SOON AS POSSIBLE. FAILURE TO FOLLOW THESE GUIDELINES COULD DAMAGE THE FUEL PUMP AND/OR THE CATALYTIC CONVERTER.**

**Characteristic**

**Fuel tank capacity**

About 10 l

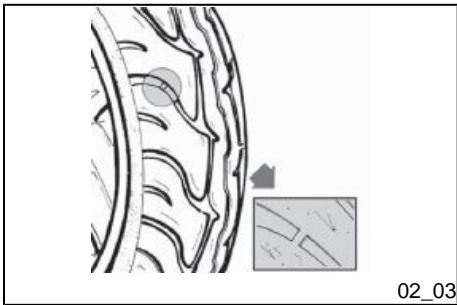

## Tyre pressure (02\_03)

Check the tyre pressure and wear periodically (roughly every 500 km). The tyres are equipped with wear indicators; the tyres should be replaced as soon as these indicators become visible on the tyre tread. Also check that tyres do not show cuts on the sides or irregular tread wear; if this occurs, go to an authorised workshop or at least a workshop equipped to perform the replacement.

### CAUTION



**TYRE PRESSURE SHOULD BE CHECKED WHEN TYRES ARE COLD. INCORRECT TYRE PRESSURE CAUSES ABNORMAL TYRE WEAR AND MAKES RIDING DANGEROUS.**

**TYRES MUST BE REPLACED WHEN THE TREAD REACHES THE WEAR LIMITS SET FORTH BY LAW.**

### Characteristic

#### Front tyre pressure

1.8 bar

#### Rear tyre pressure

2 bar

#### Rear tyre pressure - driver and passenger

2.2 bar



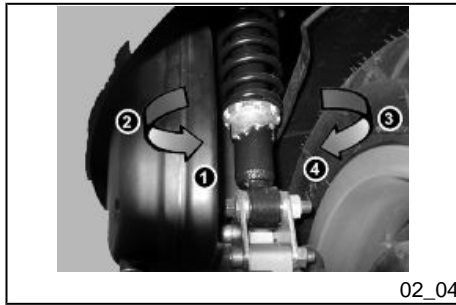

## Shock absorbers adjustment (02\_04)

The preloading of the springs can be adjusted to 4 positions acting on the ring nut located in the lower part of the shock absorbers with the specific spanner supplied.

**Position 1:** minimum preload: driver only

**Position 2** medium preloading: rider only

**Position 3** medium preloading: rider and passenger

**Position 4:** maximum preloading: rider, passenger, and luggage.

In order to carry out this operation you will need to use the specific spanner in the kit.

### CAUTION



**RIDING THE VEHICLE WITH THE SPRING PRELOADING NOT CORRECTLY SET FOR THE RIDER AND POSSIBLE PASSENGER, COULD REDUCE THE COMFORT OF THE RIDE AND THE PRECISION OF THE STEERING.**

### WARNING



**WE RECOMMEND WEARING GLOVES WHILE CARRYING OUT THIS OPERATION IN ORDER TO AVOID INJURIES.**

### WARNING



**WE STRONGLY RECOMMEND NOT TO ADJUST BOTH SHOCK ABSORBERS WITH DIFFERENT PRELOADING**



## Running in (02\_05)

### WARNING



**DURING THE FIRST 1000 KM DO NOT RIDE THE VEHICLE OVER 80% OF ITS MAXIMUM SPEED. AVOID TWISTING THE THROTTLE GRIP FULLY OR KEEPING A CONSTANT SPEED ALONG LONG SECTIONS OF ROAD. AFTER THE FIRST 1000 KM, GRADUALLY INCREASE SPEED UNTIL REACHING THE MAXIMUM PERFORMANCE.**



## Starting up the engine (02\_06, 02\_07)

To start the engine it is necessary, before pressing the starter button, to pull and keep pulled the front or rear brake lever, which activates the appropriate switch allowing start-up.

1. Rest the vehicle on its centre-stand, ensuring the rear wheel is not touching the ground.
2. Maintain the throttle grip «E» completely untwisted.
3. insert key into ignition switch «A» and turn it to "ON".
4. Make sure that the «B» "OFF-ON" switch is set to ON.
5. Pull lever «C» of the front or rear brake and then activate the starter button «D».

### WARNING



**THE AUTOMATIC TRANSMISSION MAKES THE REAR WHEEL TURN EVEN WHEN THE THROTTLE IS SLIGHTLY TWISTED. RELEASE THE BRAKE CAREFULLY AFTER STARTING, AND THEN ACCELERATE GRADUALLY.**

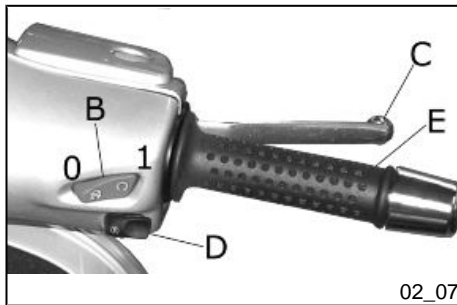

#### CAUTION



**DO NOT START-UP THE ENGINE IN CLOSED AREAS BECAUSE EXHAUST GASES ARE TOXIC.**

#### Precautions

#### WARNING



**NEVER STRESS THE ENGINE AT LOW TEMPERATURES IN ORDER TO AVOID POSSIBLE DAMAGE. BE CAREFUL NEVER TO EXCEED THE MAXIMUM SPEED WHILE RUNNING DOWNHILL, IN ORDER TO AVOID DAMAGING THE ENGINE. IN ANY CASE, IN ORDER TO PRESERVE THE ENGINE FROM PROLONGED OVERREVVING, THE REVOLUTION LIMITER WILL BE ACTIVATED IF THE ENGINE SPEED EXCEEDS THE ESTABLISHED THRESHOLD. DO NOT ACTIVATE THE REVOLUTION LIMITER RECURRENTLY SO AS TO AVOID DAMAGING THE CATALYTIC CONVERTER.**

#### WARNING



**AFTER A LONG DISTANCE COVERED AT THE MAXIMUM SPEED, DO NOT STOP THE ENGINE IMMEDIATELY, BUT LET IT RUN AT IDLE FOR A FEW SECONDS.**

## Difficult start up

In the rare case of engine flooding, to facilitate start-up, it is possible to try to put the vehicle into action with the gas hand grip partially or completely open. It is however necessary, once the engine is started, to take your vehicle to an **Authorised Service Centre** to determine the cause of this problem and to re-establish the vehicle proper functioning.



## Stopping the engine (02\_08, 02\_09)

Fully untwist the throttle grip and then turn the switch «A» to "OFF" (extractable key), or turn switch «B» to "OFF".

### CAUTION



**DUE TO THE HIGH TEMPERATURES THE CATALYTIC CONVERTER CAN REACH, ALWAYS TAKE CARE, WHEN PARKING THE VEHICLE, THAT THE EXHAUST DOES NOT COME INTO CONTACT WITH FLAMMABLE MATERIALS, TO AVOID SERIOUS BURNS.**

### CAUTION



**DO NOT SHUT OFF THE ENGINE WHILE THE VEHICLE IS MOVING. UNBURNED FUEL COULD ENTER THE CATALYTIC CONVERTER AND BURN, CAUSING THE CONVERTER TO OVERHEAT AND POSSIBLY DESTROYING IT.**

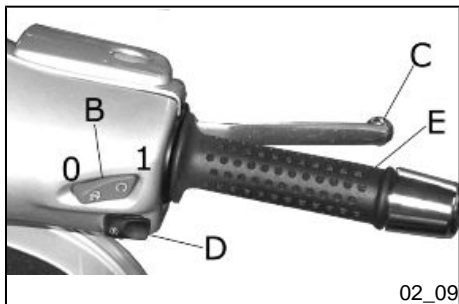

## Stand (02\_10)

### CENTRE STAND

Push with your foot on the centre stand's fork «F» while lifting the vehicle backward, holding onto the handlebar.

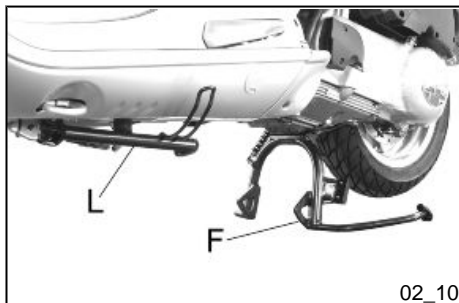

### SIDE STAND

With your foot push the projection of the stand «L » in order to open it and at the same time lean the vehicle on you.



## Automatic transmission (02\_11, 02\_12)

To ensure simple, pleasurable riding, the vehicle is equipped with automatic transmission with regulator and centrifugal clutch. The system is designed to provide the best performance (acceleration and consumption) while riding on both flat roads and uphill.

If you have to stop on an uphill slope (traffic lights, traffic jam, etc.) **use only the brake to keep the vehicle still, leaving the engine running at idle speed. Using the engine to keep the vehicle still can cause the clutch to overheat, due to the friction of the clutch mechanism itself against the clutch bell.**

It is therefore recommended to avoid conditions of prolonged clutch slippage (other than those previously indicated) like driving uphill fully laden on steep slopes or starting off with driver and passenger at slopes greater than 25%.

Observe the following precautions if the clutch overheats:



02\_12

1. Do not continue riding in such conditions.
2. Let the clutch cool down with the engine at idle speed for a few minutes.



02\_13

### Safe driving (02\_13, 02\_14)

Some simple tips are provided below that will enable you to use your scooter on a daily basis in greater safety and peace of mind. Your skill and your mechanical knowledge are the basis of a safe ride. We recommend trying out the vehicle in traffic - free zones, in order to acquire a good knowledge of the vehicle itself.

1. Before riding off, remember to put on your helmet and fasten it correctly.
2. Reduce speed on rough roads and drive with care.
3. After driving on a long stretch of wet road without using the brakes, the braking effect is initially lower. In these conditions, it is a good idea to apply the brakes from time to time.
4. Do not brake hard on wet, unsurfaced or slippery road surfaces.
5. Avoid riding off by mounting the scooter when resting on the support. In any case, the rear wheel should not be turning when it comes into contact with the ground, in order to avoid abrupt departures.
6. If driving over roads affected by sand, mud, snow mixed with salt, etc. We advise you to frequently clean the brake disc with a mild detergent to prevent the accumulation of abrasive elements inside the eyelets leading to premature wear on the brake pads.



02\_14

**CAUTION**

**ALWAYS RIDE WITHIN YOUR LIMITS RIDING UNDER THE INFLUENCE OF ALCOHOL OR OTHER DRUGS AND CERTAIN MEDICINES IS EXTREMELY DANGEROUS.**

**CAUTION**

**ANY CHANGES TO THE VEHICLE PERFORMANCE AS WELL AS ALTERATIONS TO ORIGINAL STRUCTURAL PARTS IS STRICTLY FORBIDDEN BY LAW, AND RENDERS THE VEHICLE NO LONGER CONFORMING TO THE APPROVED TYPE AND DANGEROUS FOR RIDING.**

**CAUTION**

**DO NOT ADJUST THE MIRRORS WHILE RIDING. THIS COULD CAUSE YOU TO LOOSE CONTROL OVER THE VEHICLE.**

**WARNING**

**IN ORDER TO PREVENT ANY ACCIDENTS RIDE VERY CAREFULLY AFTER ADDING ACCESSORIES AND WHILE CARRYING LUGGAGE. THE ADDITION OF ACCESSORIES AND LUGGAGE CAN REDUCE YOUR SCOOTER STABILITY AND PERFORMANCE, AS WELL AS THE LEVEL OF SAFETY DURING USE. NEVER DRIVE THE SCOOTER EQUIPPED WITH ACCESSORIES AT A SPEED HIGHER THAN 100 km/h (see section "SPARE PARTS AND ACCESSORIES")**

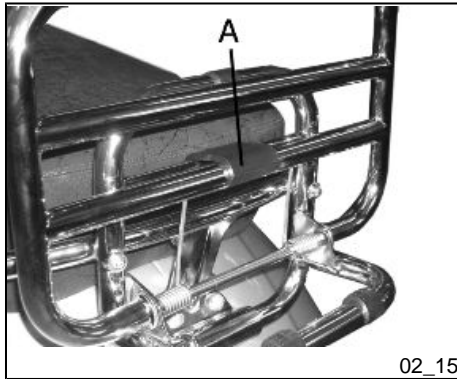

## Rear rack (02\_15)

When riding without packages on the luggage racks, set the corresponding retainer latch "A" as shown in the photograph.

### WARNING



**Maximum admissible load: 6 kg**



# Vespa GTS 125



## Chap. 03 Maintenance

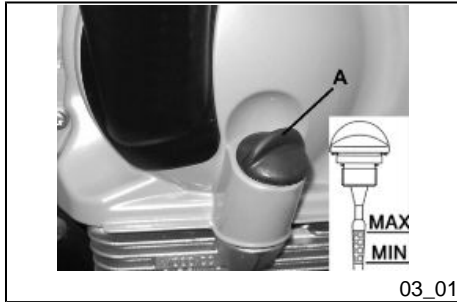

### Engine oil level (03\_01)

In 4T engines, engine oil is used to lubricate the distribution elements, main bearings and thermal group. **An insufficient quantity of oil can seriously damage the engine.** In all four-stroke engines, a loss of efficiency in oil performance and certain consumption should be considered normal. Consumption can particularly reflect the conditions of use (i.e. when driving at 'full acceleration' all the time, oil consumption increases). The replacement intervals provided for by the maintenance programme are defined depending on the total content of oil in the engine and the average consumption measured following standardised methods. **In order to prevent any problems, we recommend checking oil level more frequently than indicated in the Scheduled Maintenance table or before setting off on long journeys. The vehicle is, however, equipped with an oil pressure warning light on the instrument panel.**

### Engine oil level check (03\_02)

Every time the scooter is used, a visual check should be made on the level of the engine oil when the engine is cold. The oil level should be somewhere between the **MAX** and **MIN** index marks on the level bar; the check must be made with the scooter upright, resting on the centre stand. If the check is carried out after the vehicle has been used, and therefore with a hot engine, the level line will be lower; in order to carry out a correct check, wait at least 10 minutes after the engine has been stopped so as to get the correct level.

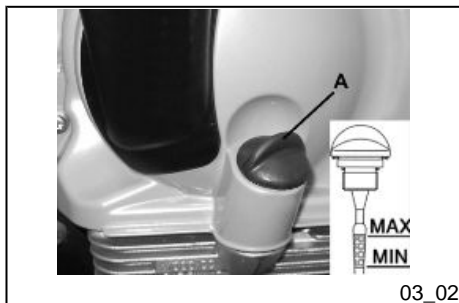

### Engine oil top-up

Any topping up with oil must be carried out after checking the oil level by adding oil, but **never exceeding the MAX level**. Getting an oil level between the **MIN** and **MAX** marks requires approx. 400 cm<sup>3</sup> of oil. Every 3000 km, however, take your scooter to an **Authorised Piaggio Service Centre** to have the engine oil level should be checked and if necessary, topped up.

### Warning light (insufficient oil pressure)

The vehicle is equipped with a warning light that comes on when the key is turned to «ON». However, this light should come off once the engine has been started. **If the light comes on while braking, at idle speed or while turning a corner, it is necessary to check the oil level and top it up if required. If after having topped-up the oil, the warning light still comes on while braking, at idle speed or while turning a corner, it will be necessary to take your vehicle to an Authorised Service Centre.**

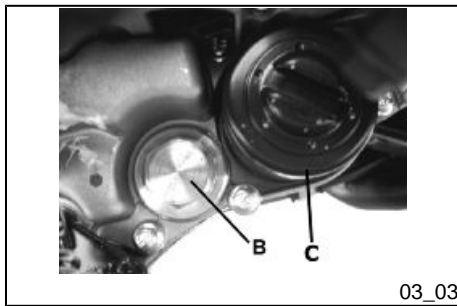

03\_03

## Engine oil change (03\_03)

The oil and the cartridge filter «C» must be changed after 1000 km and every 6000 km at an **Authorised Piaggio Service Centre**. The engine should be emptied by draining the oil from the drainage plug «B» of the gauze filter on the flywheel side. In order to facilitate the oil drainage, loosen the cap/dipstick. Since a certain quantity of oil still remains in the circuit, filling must be done with approx  $600 \div 650 \text{ cm}^3$  of oil through the cap «A». Then start up the scooter, leave it running for a few minutes and switch it off: after five minutes, check the level and if necessary top-up **without exceeding the MAX. level**. The cartridge filter must be replaced at every oil change. For top-ups and changes, use new oil of the recommended type.

### WARNING



**RUNNING THE ENGINE WITH INSUFFICIENT LUBRICATION OR WITH INADEQUATE LUBRICANTS ACCELERATES THE WEAR AND TEAR OF THE MOVING PARTS AND CAN CAUSE IRRETRIEVABLE DAMAGE.**

### WARNING



**EXCESSIVE OIL LEVEL AT TOP-UPS CAN LEAD TO SCALE FORMATION AND VEHICLE MALFUNCTION.**

### CAUTION



**USED OILS CONTAIN SUBSTANCES HARMFUL TO THE ENVIRONMENT. FOR OIL CHANGE, CONTACT AN AUTHORISED SERVICE CENTRE WHICH IS EQUIPPED TO DISPOSE OF USED OILS IN AN ENVIRONMENTALLY FRIENDLY AND LEGAL WAY.**

**CAUTION**

**USING OILS OTHER THAN THOSE RECOMMENDED CAN SHORTEN THE LIFE OF THE ENGINE.**

**Recommended products****AGIP CITY HI TEC 4T**

*Engine oil*

SAE 5W-40, API SL, ACEA A3, JASO MA Synthetic oil

**Hub oil level (03\_04, 03\_05)**

Check the oil in the rear hub. To check the rear hub oil level, proceed as follows:

- 1) Park the scooter on level ground and rest it on its stand.
- 2) Unscrew dipstick "A", wipe it clean with a cloth, reinsert it and **tighten completely**.
- 3) Pull out the dipstick and check that the oil level is above the first notch from the bottom.
- 4) Reinsert the dipstick and ensure that it is tightened correctly.

**N.B.**

**THE NOTCHES ON THE HUB OIL LEVEL DIPSTICK, EXCEPT THE ONE INDICATING THE MAX LEVEL, REFER TO OTHER MODELS BY THE MANUFACTURER AND HAVE NO SPECIFIC FUNCTION FOR THIS MODEL.**

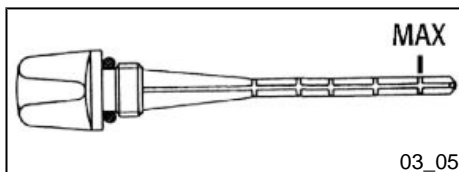
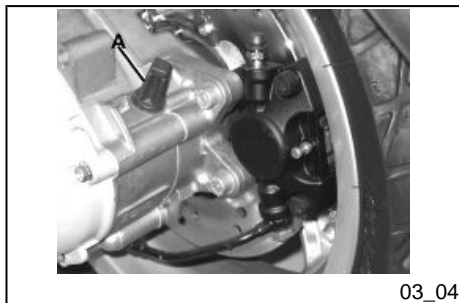

**CAUTION**



**RIDING THE VEHICLE WITH INSUFFICIENT HUB LUBRICATION OR WITH CONTAMINATED OR IMPROPER LUBRICANTS ACCELERATES THE WEAR AND TEAR OF THE MOVING PARTS AND CAN CAUSE SERIOUS DAMAGE.**

**CAUTION**



**USED OIL CAN HARM THE ENVIRONMENT. COLLECTION AND DISPOSAL SHOULD BE CARRIED OUT IN COMPLIANCE WITH REGULATIONS IN FORCE.**

**CAUTION**



**AN EXCESSIVE QUANTITY OF OIL CAN LEAD TO SPILL OVER, WHICH MAY CAUSE THE ENGINE AND THE WHEEL TO GET DIRTY.**

**CAUTION**



**WHEN REPLACING THE HUB OIL DO NOT LET THE OIL COME INTO CONTACT WITH THE REAR BRAKE DISC.**

**CAUTION**



**FOR OIL REPLACEMENT, CONTACT ANY AUTHORISED SERVICE CENTRE AS THEY ARE EQUIPPED TO DISPOSE OF USED OILS IN AN ENVIRONMENTALLY FRIENDLY AND LEGAL WAY.**

## Recommended products

### **AGIP ROTRA 80W-90**

#### *Rear hub oil*

SAE 80W/90 Oil that exceeds the requirements of API GL3 specifications

## Characteristic

### **rear hub oil capacity**

Capacity: approx. 150 cm<sup>3</sup>

## **Tyres (03\_06)**

Check tyre pressure periodically (about every 500 km). Tyres feature wear indicators; replace tyres as soon as these indicators become visible on the tyre tread. Also check that the tyres do not show signs of splitting at the side or irregular tread wear; if this occurs, go to an authorised workshop or at least to a workshop equipped to perform the replacement.

### **CAUTION**



**TYRE PRESSURE SHOULD BE CHECKED WHEN TYRES ARE COLD. INCORRECT TYRE PRESSURE CAUSES ABNORMAL TYRE WEAR AND MAKES RIDING DANGEROUS.**

**TYRES MUST BE REPLACED WHEN THE TREAD REACHES THE WEAR LIMITS SET FORTH BY LAW.**

## Characteristic

### **Front tyre pressure**

1.8 bar

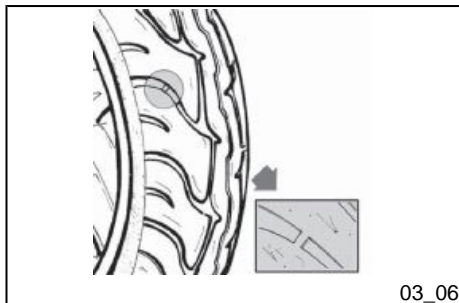

03\_06

**Rear tyre pressure**

2 bar

**Rear tyre pressure - driver and passenger**

2.2 bar

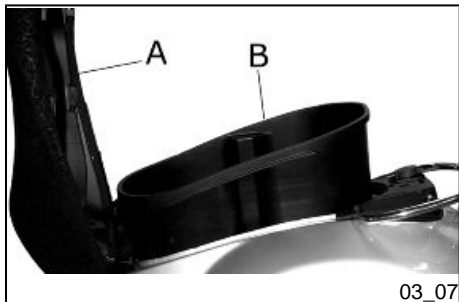

03\_07



03\_08

**Spark plug dismantlement (03\_07, 03\_08, 03\_09)**

Proceed as follows:

1. lift the saddle «A»
2. lift the helmet compartment «B» and reach into the spark plug with your hand;
3. remove the spark plug HV wire cap «C»;
4. unscrew the spark plug using the spark plug spanners «D» supplied;
5. When refitting, place the spark plug in the hole at the due inclination and screw it by hand until it is finger tight;
6. use the box-spanner «D» supplied only for locking;
7. push cap «C» fully on the spark plug.

**CAUTION**

**THE SPARK PLUG MUST BE REMOVED WHEN THE ENGINE IS COLD. THE SPARK PLUG SHOULD BE CHECKED EVERY 6,000 KM AND REPLACED EVERY 12,000 KM. THE USE OF NON-CONFORMING IGNITION CONTROL UNITS AND SPARK PLUGS OTHER THAN THOSE PRESCRIBED CAN SERIOUSLY DAMAGE THE ENGINE**





03\_09

**CAUTION**

THE USE OF SPARK PLUGS OTHER THAN THOSE RECOMMENDED OR A SHIELDLESS SPARK PLUG CAP COULD CAUSE DISTURBANCES TO THE SYSTEM.

**Characteristic****Spark plug**

Champion RG 4 HC



03\_10

**Removing the air filter (03\_10, 03\_11, 03\_12, 03\_13)**

Proceed as follows:

1. undo the fixing screws «A» and remove the left side fairing;
2. remove the helmet compartment;
3. unscrew the fixing screws «B» that can be reached after removing the helmet compartment;
4. unscrew the screws «C» and remove the air filter cover.



03\_11

Remove the filtering element and clean it with water and shampoo; then dry it with a clean cloth and short blasts of compressed air. Finally, immerse it in a mixture containing 50% oil of the recommended type and 50% petrol. Then gently squeeze the filter element between your hands, allow it to drip and then refit it. Possible oil or water deposits can be eliminated by removing the two rubber caps «D».

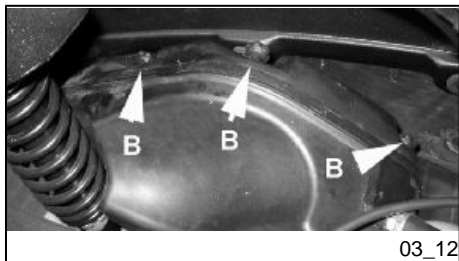

03\_12

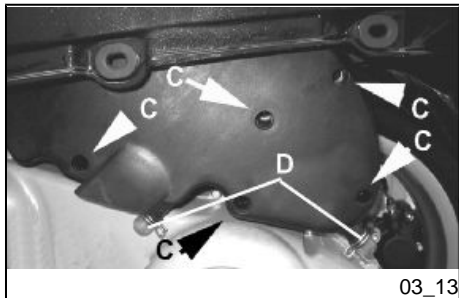

03\_13

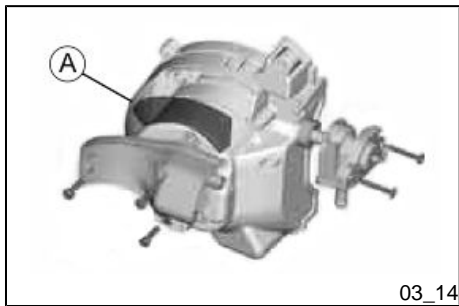

03\_14

**CAUTION**

IF THE VEHICLE IS USED ON DUSTY ROADS, IT IS NECESSARY TO SERVICE THE AIR FILTER MORE OFTEN TO AVOID DAMAGING THE ENGINE.

**CAUTION**

IN ORDER NOT TO DAMAGE THE VEHICLE PLASTIC COVERS CONTACT AN AUTHORISED SERVICE CENTRE TO HAVE THE AIR FILTER CLEANED.

**Recommended products****AGIP FILTER OIL**

*Oil for air filter sponge*

Mineral oil with specific additives for increased adhesiveness

**Secondary air system (03\_14)**

In order to reduce polluting emissions, the vehicle is furnished with a catalytic converter in the muffler.

To facilitate the catalytic process, a further quantity of previously filtered air is brought in through the exhaust duct on the head by the secondary air system (SAS).

This system allows more oxygen to be added to the unburned gases before reaching the catalytic converter, thus improving the catalytic converter reaction.

The system has a control valve that disables operation during deceleration in order to avoid abnormal noises.

To ensure the best functioning of the SAS, take your vehicle to an **Authorised Piaggio Service Centre** for maintenance operations, at the intervals indicated in the scheduled maintenance table.

This system requires a filter «A».

The filter sponge should be cleaned with water and mild soap, then it should be dried with a cloth and slight blows of compressed air.



03\_15

### Cooling fluid level (03\_15, 03\_16)

Engine cooling is carried out by a forced-circulation coolant system. The cooling circuit holds approx. 2.100 ÷ 2.150 l of coolant consisting of a mixture of 50% de-ionised water and 50% glycol ethylene-based antifreeze solution with corrosion inhibitors. The recommended coolant, supplied with the scooter, is already mixed and ready for use. For proper functioning of the engine, ensure that the pointer of the coolant temperature gauge remains in the middle area of the scale. If the pointer of the gauge enters the red zone, shut off the engine, allow it to cool down and check the coolant level; if level is OK, take your scooter to an **Authorised Piaggio Service Centre**. Should the coolant level exceed the above values during a non-demanding ride, shut off the engine and let it cool down. Then check the coolant level. If level is OK, take your scooter to an **Authorised Piaggio Service Centre**. Check coolant when the engine is cold at the intervals indicated in the scheduled maintenance table, following the steps below.

- a) Place the scooter in a vertical position on the stand.
- b) Unscrew the fixing screw «A» and remove the cover.
- c) Check the fluid level according to the two marks- MIN and MAX «B» on the reservoir
- d) Top-up, if required, if the fluid level is below the MIN level on the scale inside the expansion tank. The fluid level must always be between MIN and MAX level

If the fluid is near the minimum level, top-up only when the engine is cold. If it is necessary to top up the coolant frequently, or if the expansion tank is completely dry, you should look for the cause in the cooling system. It is therefore indispensable to have the cooling system checked at an **Authorised Piaggio Service Centre**. Change



03\_16

coolant at the intervals indicated in the scheduled maintenance table. For this operation, please contact an **Authorised Piaggio Service Centre**.

**WARNING**

**TO AVOID THE RISK OF SCALDING, DO NOT UNSCREW THE EXPANSION TANK COVER WHILE THE ENGINE IS STILL HOT.**

**WARNING**

**TO PREVENT AVOID HARMFUL FLUID LEAKAGE WHILE RIDING, ENSURE THAT THE LEVEL NEVER EXCEEDS THE MAXIMUM VALUE.**

**TO ENSURE CORRECT ENGINE OPERATION, KEEP THE RADIATOR GRILLE CLEAN.**

**Recommended products****SPECIAL AGIP PERMANENT fluid***coolant*

Monoethylene glycol-based antifreeze fluid, CUNA NC 956-16

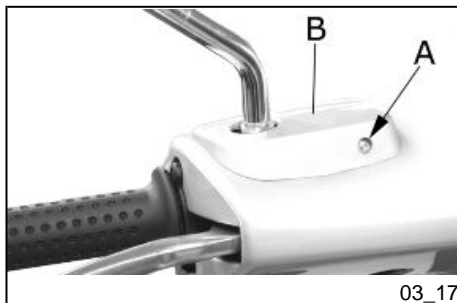

03\_17

### Checking the brake oil level (03\_17, 03\_18)

The brake fluid reservoirs are located on the pumps under the front handlebar cover (front on the right-hand side, rear on the left-hand side). The procedures to checking the brake fluid level for the front and rear brakes are identical.

Proceed as follows:

1. rest the scooter on its centre stand and make sure the handlebar is centred;
2. loosen screw "A" and remove cover "B";
3. check the fluid level through the respective sight glass "C".

A certain lowering of the level is caused by wear on the pads. Should the level appear to be below the minimum mark, please contact your nearest **Authorised PIAGGIO Dealer or Service Centre** in order to have braking system thoroughly inspected. Proceed as follows:

Remove tank cover «D» and loosen the two screws «E» and top-up the brake fluid level using only the prescribed brake fluid and without exceeding the maximum level.

Under normal climatic conditions, the brake fluid should be replaced every 2 years. This operation must be carried out by trained technicians; take your scooter to a **PIAGGIO Dealer or authorised Service Centre**.

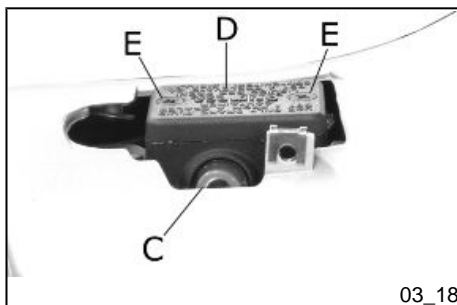

03\_18

#### WARNING



**ONLY USE DOT 4 CLASS BRAKE FLUIDS. BRAKING CIRCUIT FLUIDS ARE HIGHLY CORROSIVE. MAKE SURE THAT IT DOES NOT COME INTO CONTACT WITH THE PAINTWORK**

#### CAUTION



**AVOID CONTACT OF BRAKE FLUID WITH EYES, SKIN, AND CLOTHING. IN CASE OF CONTACT, RINSE WITH WATER. THE BRAKING CIRCUIT FLUID IS**

**HYGROSCOPIC, THAT IS, IT ABSORBS HUMIDITY FROM THE SURROUNDING AIR. IF THE HUMIDITY IN THE BRAKING FLUID EXCEEDS A CERTAIN VALUE, IT WILL LEAD TO INEFFICIENT BRAKING. NEVER USE BRAKING FLUID KEPT IN CONTAINERS THAT HAVE ALREADY BEEN OPENED, OR PARTIALLY USED.**

### **Recommended products**

#### **AGIP BRAKE 4**

*Brake fluid*

FMVSS DOT 4 Synthetic fluid

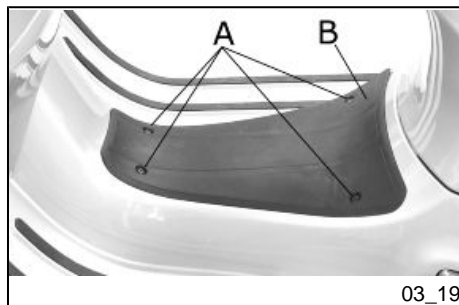

### **Battery (03\_19, 03\_20, 03\_21)**

To reach the battery «D», proceed as follows:

1. rest the scooter on its centre stand;
2. unscrew the 4 screws «A», remove the footrest «B».
3. remove the two battery fixing screws «C».

The battery is the electrical device that requires the most frequent inspections and diligent maintenance. The main points of maintenance to be observed are as follows:

#### **CAUTION**



**IN ORDER TO AVOID DAMAGING THE ELECTRICAL SYSTEM, NEVER DISCONNECT THE WIRING WHILE THE ENGINE IS RUNNING. DO NOT TIP THE SCOOTER TOO MUCH IN ORDER TO AVOID DANGEROUS LEAKS OF BATTERY ELECTROLYTE**



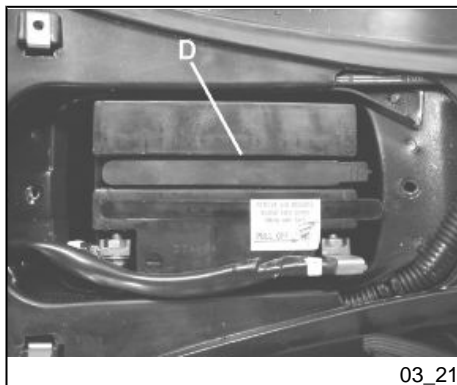

03\_21

**CAUTION**

**ELECTROLYTE CONTAINS SULPHURIC ACID: AVOID CONTACT WITH EYES, SKIN AND CLOTHES. IN CASE OF ACCIDENTAL CONTACT, RINSE WITH ABUNDANT WATER AND CONSULT A DOCTOR.**

**WARNING**

**USED BATTERIES ARE HARMFUL FOR THE ENVIRONMENT. COLLECTION AND DISPOSAL SHOULD BE CARRIED OUT IN COMPLIANCE WITH REGULATIONS IN FORCE.**

**Use of a new battery**

Ensure that the terminals are connected correctly and check voltage.

**CAUTION**

**DO NOT REVERSE THE POLARITY: RISK OF SHORT CIRCUIT AND DAMAGE TO THE ELECTRICAL SYSTEM.**

**WARNING**

**USED BATTERIES ARE HARMFUL FOR THE ENVIRONMENT. COLLECTION AND DISPOSAL SHOULD BE CARRIED OUT IN COMPLIANCE WITH REGULATIONS IN FORCE.**

## Long periods of inactivity

Battery performance will decrease if the vehicle is not used for a long time. This is the result of the natural phenomenon of battery discharging plus residual absorption by vehicle components with constant power consumption. Poor battery performance may also be due to environmental conditions and the cleanliness of the poles. In order to avoid difficult starts and/or irreversible damage to the battery, follow any of these steps:

- **At least once a month** start the engine and run it slightly above idle speed for 10-15 minutes. This keeps all the engine components, as well as the battery, in good working order.
- Take your vehicle to a garage (as indicated in the «Vehicle not used for extended periods» section) to have the battery removed. Have the battery cleaned, charged fully and stored in a dry, ventilated place. Recharge **at least once every two months**.

### N.B.

**THE BATTERY MUST BE CHARGED WITH A CURRENT EQUAL TO 1/10 OF THE RATED CAPACITY OF THE BATTERY AND FOR NOT LONGER THAN 10 HOURS. CONTACT AN AUTHORISED SERVICE CENTRE TO CARRY OUT THIS OPERATION SAFELY. WHEN REFITTING THE BATTERY MAKE SURE THE LEADS ARE CORRECTLY CONNECTED TO THE TERMINALS.**

### WARNING



**DO NOT DISCONNECT THE BATTERY CABLES WITH THE ENGINE RUNNING, THIS CAN CAUSE PERMANENT DAMAGE TO THE VEHICLE ELECTRONIC CONTROL UNIT.**



**WARNING**

**USED BATTERIES ARE HARMFUL FOR THE ENVIRONMENT. COLLECTION AND DISPOSAL SHOULD BE CARRIED OUT IN COMPLIANCE WITH REGULATIONS IN FORCE.**

**Fuses (03\_22, 03\_23)**

The electrical system is equipped with:

1. six protection fuses «**A**» located in the glove compartment to the left
2. one 15A fuse «**B**» located under the helmet compartment under the saddle hinge latch.

The chart shows the position and characteristics of the fuses in the vehicle.

**CAUTION**

**BEFORE REPLACING A BLOWN FUSE, FIND AND SOLVE THE FAILURE THAT CAUSED IT TO BLOW. NEVER TRY TO REPLACE A FUSE WITH ANY OTHER MATERIAL (A PIECE OF ELECTRIC WIRE, FOR INSTANCE).**

**CAUTION**

**MODIFICATIONS OR REPAIRS TO THE ELECTRICAL SYSTEM, PERFORMED INCORRECTLY OR WITHOUT STRICT OBSERVANCE OF THE TECHNICAL SPECIFICATIONS OF THE SYSTEM, CAN CAUSE OPERATING ERRORS AND RISK OF FIRE.**

## FUSES

Fuse 1                      **Current rating:** 10 A  
**Protected circuits:** High-/low-beam headlight bulb, high-beam warning light.

Fuse 2                      **Current rating:** 7.5 A  
**Protected circuits:** Saddle-opening actuator, immobilizer LED, anti-theft device pre-installation, key switch

Fuse 3                      **Current rating:** 7.5 A  
**Protected circuits:** Horn, antitheft device pre-installation, oil pressure sensor, oil pressure warning light, water temperature gauge, thermistor, fuel gauge, low fuel warning light, fuel level transmitter.

Fuse 4                      **Current rating:** 5 A  
**Protected circuits:** Instrument panel lighting bulbs and warning lights, tail lights, license plate light.

Fuse 5                      **Current rating:** 5 A  
**Protected circuits:** Stop light, starter motor.

Fuse 6                      **Current rating:** 3 A

**Protected circuits:** Electric pump control device, fuel electric pump

Fuse 7

**Current rating:** 15A

**Protected circuits:** General

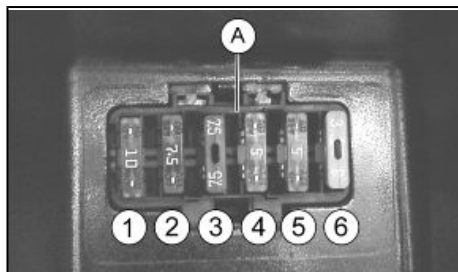

03\_22

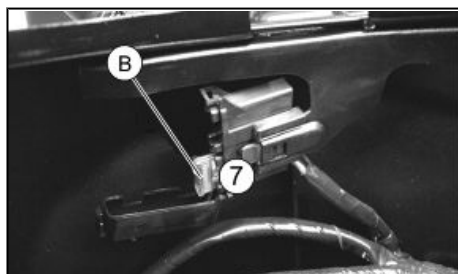

03\_23

## **BULBS**

Low-/high-beam light bulb	<b>Type:</b> HALOGEN (H4) <b>Power:</b> 12V - 55/60W <b>Quantity:</b> 1
---------------------------	---

Front tail light bulb	<b>Type:</b> ALL GLASS <b>Power:</b> 12V - 5W <b>Quantity:</b> 2
-----------------------	--

Licence plate light bulb	<b>Type:</b> ALL GLASS <b>Power:</b> 12V - 5W <b>Quantity:</b> 1
--------------------------	--

Front turn indicator bulb	<b>Type:</b> ALL GLASS <b>Power:</b> 12V - 10W <b>Quantity:</b> 2
---------------------------	---

Rear turn indicator bulb	<b>Type:</b> SPHERICAL (AMBER) <b>Power:</b> 12V - 10W <b>Quantity:</b> 2
--------------------------	---

Rear tail light bulb	<b>Type:</b> ALL GLASS <b>Power:</b> 12V - 5W <b>Quantity:</b> 1
----------------------	--

Stop light bulb	<b>Type:</b> ALL GLASS
-----------------	------------------------

	<b>Power:</b> 12V - 16W <b>Quantity:</b> 1
Tail light warning light bulb	<b>Type:</b> ALL GLASS <b>Power:</b> 12V - 2W <b>Quantity:</b> 1
High-beam warning light bulb	<b>Type:</b> ALL GLASS <b>Power:</b> 12V - 1.2W <b>Quantity:</b> 1
Low fuel warning light bulb	<b>Type:</b> ALL GLASS <b>Power:</b> 12V - 1.2W <b>Quantity:</b> 1
Oil pressure warning light bulb	<b>Type:</b> ALL GLASS <b>Power:</b> 12V - 1.2W <b>Quantity:</b> 1
(Right and left) turn indicator warning light bulbs	<b>Type:</b> ALL GLASS <b>Power:</b> 12V - 2W <b>Quantity:</b> 2
Panel lighting bulb	<b>Type:</b> ALL GLASS <b>Power:</b> 12V - 2W <b>Quantity:</b> 3

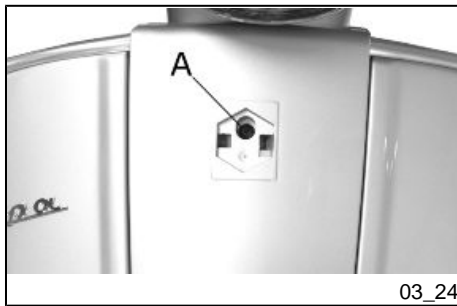

03\_24

## Front light group (03\_24, 03\_25, 03\_26, 03\_27, 03\_28)

To remove the front headlight assembly, proceed as follows:

- 1: remove rear-view mirrors.
- 2: Remove the screws «A» of the front shield grille.
- 3: Remove the fixing screws «B» of the front handlebar cover.
- 4: Remove the fixing screws «C» of the rear handlebar cover
- 5: Remove the front handlebar cover.

So there is access to the bulbs. Open the clip and take out the high-/low-beam light bulb «D». To change the tail light take out the rubber light socket from the seat. To reassemble, repeat the operation in the reverse order.

### WARNING



**THE TWIN-FILAMENT (HIGH-BEAM AND LOW-BEAM) BULB IS HALOGEN: DO NOT TOUCH THE BULB WITH YOUR FINGERS TO AVOID COMPROMISING ITS FUNCTIONING**

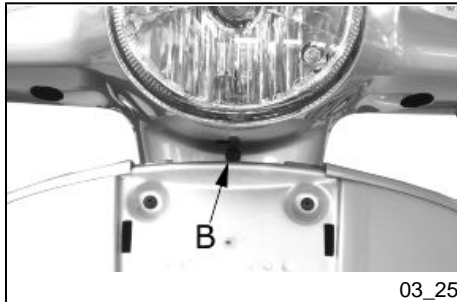

03\_25



03\_26

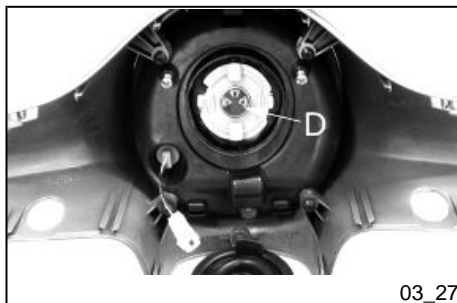

03\_27



03\_28

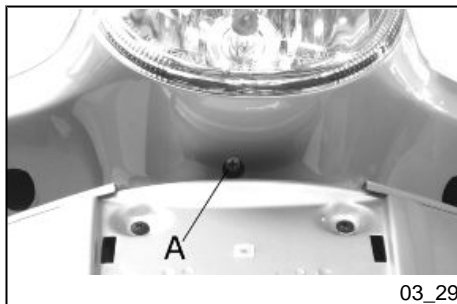

03\_29

### Headlight adjustment (03\_29, 03\_30)

Proceed as follows:

1. Place the vehicle, in running order and with the tyres inflated to the prescribed pressure, on a flat surface 10-m away from a white screen situated in a shaded area, making sure that the longitudinal axis of the scooter is perpendicular to the screen;
2. Turn on the headlight and check that the borderline of the projected light beam on the screen is not higher than 9/10 or lower than 7/10 of the distance from the ground to the centre of vehicle headlamp;
3. If otherwise, adjust the right headlight with screw «A».

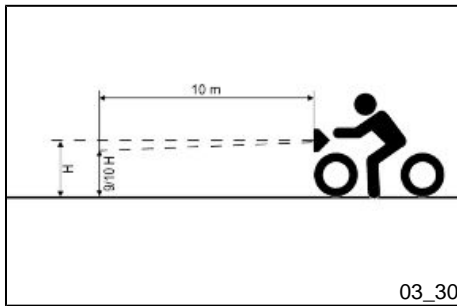

**N.B.**

THE ABOVE PROCEDURE COMPLIES WITH THE EUROPEAN STANDARDS REGARDING MAXIMUM AND MINIMUM HEIGHT OF LIGHT BEAMS. REFER TO THE STATUTORY REGULATIONS IN FORCE IN EVERY COUNTRY WHERE THE VEHICLE IS USED.

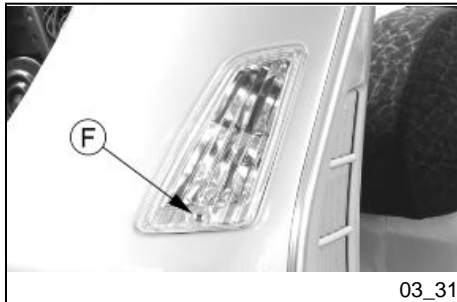

### Front direction indicators (03\_31)

To replace the burnt bulb, remove the screws «F»





### Rear optical unit (03\_32)

Remove screw «A» to remove the rear headlight assembly.

Access to taillight bulbs, stop light bulb and license plate bulb.

To reassemble, repeat the operation in the reverse order.

#### **N.B.**

**IF MISTING IS NOTICED ON THE INSIDE OF THE HEADLAMP GLASS, THIS DOES NOT INDICATE A FAULT AND IS ATTRIBUTABLE TO HUMIDITY AND/OR TO LOW TEMPERATURES.**

**THE PHENOMENON SHOULD QUICKLY DISAPPEAR WHEN THE LIGHT IS SWITCHED ON.**

**THE PRESENCE OF DROPS OF WATER, ON THE OTHER HAND, COULD INDICATE THAT WATER IS INFILTRATING. CONTACT THE AFTER-SALES SERVICE NETWORK.**

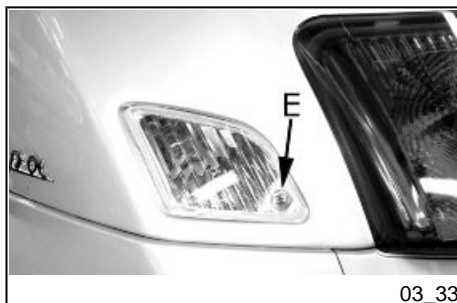

### Rear turn indicators (03\_33)

To gain access to the turn indicator bulbs, remove the fastening screws «E».

The bulbs have a bayonet coupling, to remove them press gently and twist anticlockwise about 30°. To refit follow the same steps but in reverse order.

## Rear-view mirrors

Adjust the mirrors by applying slight pressure to the side of the mirror to move it to the desired position.

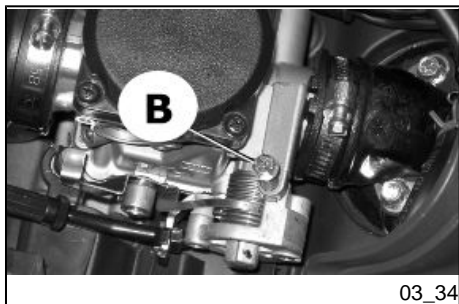

## Idle adjustment (03\_34)

Proceed as follows:

1. rest the vehicle on its stand, lift the saddle and remove the helmet compartment.
2. to adjust idle speed, start the engine, then tighten or loosen the screw «B» until you reach the recommended idle speed making sure the engine does not make the rear wheel move.

If adjustment is difficult, take the vehicle to an **Authorised Piaggio Service Centre or Dealer**.

### WARNING



**IDLE SPEED MUST BE ADJUSTED WHEN THE ENGINE IS VERY HOT. BEFORE THIS OPERATION, MAKE SURE THAT THE THROTTLE GRIP HAS THE RECOMMENDED BACKLASH. IF BACKLASH IN THE THROTTLE CONTROL TRANSMISSION NEEDS ADJUSTING TAKE YOUR SCOOTER TO AN AUTHORISED DEALER OR SERVICE CENTRE.**

## Characteristic

### Idle speed adjustment

about 1650±100 rpm

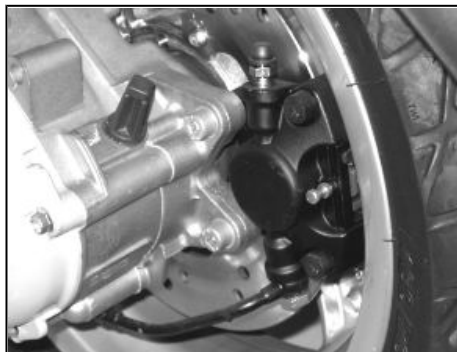

03\_35

### Front and rear disc brake (03\_35, 03\_36)

The brake disc and pad wear is automatically compensated, therefore it has no effect on the functioning of the front and rear brakes. For this reason it is not necessary to adjust the brakes. An excessively elastic brake lever stroke may indicate the presence of air in the braking circuit or a failure in the braking system. In this case, mainly due to the importance of brakes to guarantee safe riding conditions, the vehicle should be taken to an **Authorised Service Centre or Dealer**.

#### CAUTION



**BRAKING SHOULD BEGIN AFTER ABOUT 1/3 OF THE BRAKE LEVER STROKE.**

#### CAUTION



**HAVE THE BRAKE PADS CHECKED BY THE DEALER ACCORDING TO THE CHECKS SPECIFIED IN THE SCHEDULED MAINTENANCE TABLE. HOWEVER, IN THE EVENT OF NOISES COMING FROM THE FRONT AND/OR REAR BRAKING SYSTEM DURING OPERATION, IT IS ADVISABLE TO HAVE THE BRAKING SYSTEM CHECKED BY AN AUTHORISED SERVICE CENTRE OR DEALER. AFTER REPLACING THE BRAKE PADS, DO NOT USE THE SCOOTER UNTIL YOU HAVE OPERATED THE BRAKE LEVER SEVERAL TIMES IN ORDER TO ALLOW THE PLUNGERS TO SETTLE AND THE LEVER STROKE TO BE SET TO THE CORRECT POSITION.**

#### CAUTION



**THE PRESENCE OF SAND, MUD, SNOW MIXED WITH SALT, ETC. ON THE ROAD, CAN DRASTICALLY REDUCE THE LIFE OF THE BRAKE PADS. IN ORDER TO AVOID THIS, WE RECOMMEND WASHING THE VEHICLE FREQUENTLY WHEN RIDING IN THESE ROAD CONDITIONS.**



03\_36

## Puncture

The vehicle is equipped with Tubeless tyres (without inner tube). In the event of a puncture, Tubeless tyres - unlike tyres with inner tubes - go flat very slowly, resulting in a greater steering safety. In the event of a puncture, an emergency repair can be carried out using an "inflate and repair" spray can. For a final repair, take your vehicle to an **Authorised Service Centre or Dealer**. The replacement of a tyre involves removing the wheel in question. Take your vehicle to an **Authorised Service Centre or Dealer** for these operations.

### CAUTION



**TO USE THE "INFLATE AND REPAIR" SPRAY CAN PROPERLY, FOLLOW THE INSTRUCTIONS ON THE PACKAGING.**

### WARNING



**THE WHEELS FITTED WITH TYRES SHOULD ALWAYS BE BALANCED. RIDING THE VEHICLE WITH VERY LOW TYRE PRESSURE OR WITH INCORRECTLY BALANCED TYRES CAN LEAD TO DANGEROUS STEERING VIBRATIONS.**



03\_37

## Periods of inactivity (03\_37)

We recommend carrying out the following operations:

1. Clean the scooter thoroughly and then cover it with a canvas;
2. With engine off and piston at the bottom dead centre, remove the spark plug, fill with 1÷2 cc oil (larger amounts are dangerous for the engine itself). Operate the starter button 1-2 times for roughly 1 second to turn the engine over slowly, then insert the spark plug again;
3. Drain all the fuel from the scooter; spread antirust grease on the unpainted metal parts; keep the wheels lifted above the ground by resting the chassis on two wooden wedges;
4. As regards the battery, follow the instructions in the "Battery" section.

## Recommended products

### AGIP CITY HI TEC 4T

*Oil to lubricate flexible transmissions (throttle control)*

Oil for 4-stroke engines

## Cleaning the vehicle

Use a low pressure water jet in order to soften the dirt and mud deposited on painted surfaces. Once softened, mud and dirt must be removed with a soft sponge for body-work soaked with water and shampoo (2-4% of shampoo in water). Then rinse abundantly with water, and dry with a shammy cloth. Any polishing with silicon wax must always be preceded by washing

### CAUTION



**DETERGENTS CAN POLLUTE WATER. THE VEHICLE MUST BE WASHED AT A WASH STATION EQUIPPED WITH A SPECIAL WATER PURIFICATION SYSTEM.**

**WARNING**

**THE USE OF A HIGH-PRESSURE WATER JET IS STRONGLY DISCOURAGED FOR ANY ENGINE CLEANING OPERATION; HOWEVER, IF NO OTHER MEANS ARE AVAILABLE, IT IS THEN NECESSARY TO:**

- **ONLY USE A FANLIKE SPRAY JET.**
- **DO NOT PLACE THE NOZZLE CLOSER THAN 60 CM.**
- **DO NOT USE WATER AT TEMPERATURES OVER 40°C.**
- **DO NOT USE HIGH-PRESSURE WATER JETS.**
- **DO NOT STEAM WASH.**
- **DO NOT AIM THE JET DIRECTLY AT: THE CARBURETTOR, THE ELECTRIC CABLES, THE SLOT DIFFUSERS IN THE TRANSMISSION COVER AND THE SCROLL COVER.**

**WARNING**

**NEVER WASH THE SCOOTER IN DIRECT SUNLIGHT, ESPECIALLY DURING SUMMER WHEN THE BODYWORK IS STILL HOT, AS THE SHAMPOO CAN DAMAGE THE PAINTWORK IF IT DRIES BEFORE BEING RINSED OFF. NEVER USE CLOTHS SOAKED IN PETROL, DIESEL OIL OR KEROSENE FOR CLEANING THE PAINTED OR PLASTIC SURFACES SO AS NOT TO DAMAGE THE LUSTRE FINISH OR ALTER THE MECHANICAL PROPERTIES.**

**DIFFICULT STARTING**

No fuel in tank	Refuel
Filters, carburettor jets dirty or clogged, fuel filter, fuel pipes clogged, fuel pump damaged	Contact an <b>Authorised Piaggio Service Centre</b>
Battery flat	Recharge the battery.

**IGNITION PROBLEMS**

No spark from spark plug. Due to the presence of high voltage, this element should only be checked by an expert.	Contact an <b>Authorised Piaggio Service Centre</b>
--	---

**LACK OF COMPRESSION**

Spark plug loose. Loose cylinder head, worn piston retaining rings.	Screw the spark plug.
Incorrect valve clearance	Contact an <b>Authorised Piaggio Service Centre</b>

## **HIGH CONSUMPTION AND LOW PERFORMANCE**

Air filter blocked or dirty.	Clean with water and shampoo and impregnate with petrol and specific oil («Air filter removal» section)
------------------------------	---

## **INSUFFICIENT BRAKING**

Greasy disc. Worn pads	Contact an <b>Authorised Piaggio Service Centre</b>
Air in the front and rear brake circuits	Contact an <b>Authorised Piaggio Service Centre</b>

## **INEFFICIENT SUSPENSIONS**

Inefficient shock absorbers, oil leakage, deteriorated end of stroke buffers.	Contact an <b>Authorised Service Centre</b>
---	---

## **AUTOMATIC TRANSMISSION PROBLEMS**

Deteriorated variable speed rollers and/or driving belt and/or clutch	Contact an <b>Authorised Service Centre</b>
---	---



## EXHAUST NOISE

Depression tube damaged/  
disconnected or secondary valve  
damaged

Contact an **Authorised Service  
Centre**



# Vespa GTS 125

**Vespa®**



**Chap. 04**  
**Technical data**



**TECHNICAL DATA**

Engine	single-cylinder, four-stroke
Bore x stroke	57 x 48.6 mm
Cubic capacity	124 cm <sup>3</sup>
Compression ratio	11.5 ÷ 12.5 :1
Ignition/advance	Electronic, with inductive discharge and variable advance with three-dimensional mapping
Carburettor KEIHIN	CVK30
Spark plug	CHAMPION RG4HC
Max speed	102 km/h
Valve clearance	intake: 0.10 mm discharge: 0.15 mm
Overall length	1940 mm
Overall width	755 mm
Overall height	1180 mm
Wheelbase	1395 mm
Fuel supply	Unleaded petrol; carburettor and electrical pump.
Exhaust muffler	Absorption-type exhaust muffler with catalytic converter.
Electronic ignition	capacitative, with variable timing and separate HV coil

Lubrication	Engine lubrication with lobe pump (inside crankcase), chain-driven, with double filter: mesh and paper.
Start-up	Electric
Cooling	Forced liquid circulation cooling.
Transmission	Automatic expandable pulley variator with torque server, V belt, automatic centrifugal dry clutch, gear reduction unit and transmission compartment with forced air circulation cooling.
Front brake	Ø 220 disc brake with hydraulic control activated by handlebar right lever.
Rear brake	disc brake, diameter 220 mm, with hydraulic servo operated from the handlebar with the left-hand lever.
Front wheel	Alloy rims: 12" x 3.00"
Rear wheel	Alloy rims: 12" x 3.00"
Front tyre	Without inner tube 120/70-12" 51P
Rear tyre	Without inner tube: 130/70-12" 62P
Front suspension	Single arm suspension (cantilever wheel) fitted with a dual-chamber hydraulic shock absorber with coaxial spring.
Rear suspension	single arm with two double-acting hydraulic shock absorbers and preloading adjustment in 4 positions.
Chassis	Stamped plate supporting body.

dry weight	140 kg.
Maximum admitted weight	~ 340 kg
Fuel tank capacity	About 10 l
Fuel reserve	~ 2.0 l (approximate value)
Engine oil	Capacity: 1.1 l (dry) ; 1.0 l (when changing oil and filter)
rear hub oil capacity	Capacity: approx. 150 cm <sup>3</sup>
Cooling system	Capacity: ~ 2.100 ÷ 2.150 l



04\_02

### Kit equipment (04\_02)

One box-spanner for spark plugs; one twin screwdriver; one special spanner for adjusting the rear shock absorber. The tools are arranged in the front case.





# Vespa GTS 125

**Vespa®**



## **Chap. 05 Spare parts and accessories**



05\_01

## Warnings (05\_01)

### WARNING



TO PREVENT ACCIDENTS AND TO GUARANTEE PROPER STABILITY, PERFORMANCE AND SAFETY, RIDE THE VEHICLE VERY CAREFULLY WHEN IT IS FITTED WITH ACCESSORIES OR WITH UNUSUAL LOADS.

### WARNING



IT IS ALSO RECOMMENDED THAT ORIGINAL PIAGGIO SPARE PARTS BE USED, AS THESE ARE THE ONLY ONES OFFERING YOU THE SAME QUALITY GUARANTEE AS THOSE INITIALLY FITTED ON THE SCOOTER. THE USE OF NON-ORIGINAL SPARE PARTS RENDERS THE WARRANTY VOID.

### WARNING



PIAGGIO MARKETS ITS OWN LINE OF ACCESSORIES THAT ARE RECOGNISED AND GUARANTEED FOR USE. IT IS THEREFORE ESSENTIAL TO CONTACT AN AUTHORISED DEALER OR SERVICE CENTRE IN ORDER TO CHOOSE AND FIT ACCESSORIES CORRECTLY. THE USE OF NON-ORIGINAL ACCESSORIES MAY AFFECT THE STABILITY AND OPERATION OF YOUR VEHICLE AND REDUCE SAFETY LEVELS WITH POTENTIAL RISKS FOR THE RIDER.

**WARNING**

**NEVER RIDE THE SCOOTER EQUIPPED WITH ACCESSORIES (TOP BOX AND/OR WINDSHIELD) AT A SPEED HIGHER THAN 100 km/h.**

**THE SCOOTER CAN BE RIDDEN AT A HIGHER SPEED WITHOUT THE ACCESSORIES MENTIONED BEFORE WITHIN THE LIMITS ESTABLISHED BY LAW.**

**IF THERE ARE ANY NON-PIAGGIO ACCESSORIES INSTALLED, OR AN ABNORMAL LOAD, OR IF THE SCOOTER IS NOT IN A GENERALLY GOOD CONDITION, OR WHENEVER WEATHER CONDITIONS DEMAND IT, SPEED SHOULD BE FURTHER REDUCED.**

**WARNING**

**BE EXTREMELY CAREFUL WHEN INSTALLING AND REMOVING THE MECHANICAL ANTITHEFT DEVICE ON THE VEHICLE ( U-SHAPED PADLOCK, DISC BLOCK, ETC.).**

**MAINLY NEAR THE BRAKE PIPES, TRANSMISSIONS AND/OR ELECTRIC CABLES, AN INCORRECT INSTALLATION OR REMOVAL OF THE ANTITHEFT DEVICE AS WELL AS LEAVING IT ON BEFORE STARTING THE VEHICLE CAN SERIOUSLY DAMAGE ITS COMPONENTS, COMPROMISE THE CORRECT FUNCTIONING OF THE VEHICLE AND USERS' SAFETY.**



# Vespa GTS 125

**Vespa®**



## **Chap. 06 Programmed maintenance**

## Scheduled maintenance table

Adequate maintenance is fundamental to ensure long-lasting, optimum operation and performance of your vehicle.

To this end, a series of checks and maintenance operations (at the owner's expense) have been suggested, which are included in the summary table on the following page. Any minor faults should be reported without delay to an **Authorised Service Centre or Dealer** without waiting until the next scheduled service to solve it.

All scheduled maintenance services must be carried out at the specified intervals, even if the stated mileage has not yet been reached. Punctual scooter servicing is essential to ensure your warranty remains valid. For any further information concerning Warranty procedures and 'Scheduled Maintenance', please refer to the 'Warranty Booklet'.

### AFTER 1000 KM

Engine oil - replacement
--------------------------

Hub oil - change
------------------

Engine oil - change
---------------------

Idle speed (*) - adjustment
-----------------------------

Throttle lever - adjustment
-----------------------------

Steering - adjustment
-----------------------

Brake control levers - greasing
---------------------------------

Brake pads - check condition and wear
---------------------------------------

Brake fluid level - check
---------------------------

Safety locks - check
----------------------

Electrical system and battery - check

Tyre pressure and wear - check

Vehicle and brake test - road test

(\*) See instructions in «Idle speed adjustment» section

### **EVERY 3,000 KM**

Engine oil - level check/ top-up

### **AFTER 6000 KM**

Engine oil - replacement

Hub oil level - check

Spark plug/ electrode gap - check

Air filter - clean

Engine oil - change

valve clearance - check

Variable speed rollers - check or replacement

Driving belt - checking

Coolant level - check

Brake pads - check condition and wear

Brake fluid level - check

Electrical system and battery - check

Tyre pressure and wear - check

Vehicle and brake test - road test

### **AFTER 12,000 KM; 60,000 KM**

Engine oil - replacement

Hub oil level - check

Air filter - clean

Engine oil - change

Spark plug - replacement

Idle speed (\*) - adjustment

Throttle lever - adjustment

Driven pulley roller casing - Greasing

Driving belt - replacement

Sliding blocks / variable speed rollers - check

Coolant level - check

Steering - adjustment

Brake control levers - greasing

Brake pads - check condition and wear

Brake fluid level - check



---

Transmission elements - lubrication

---

Safety locks - check

---

Suspensions - check

---

Electrical system and battery - check

---

Headlight - adjustment

---

Tyre pressure and wear - check

---

Vehicle and brake test - road test

---

*(\*) See instructions in the «Idle speed adjustment» section*

### **AT 18000 KM AND AT 54000 KM**

---

Engine oil - replacement

---

Hub oil level - check

---

Spark plug/ electrode gap - check

---

Air filter - clean

---

Engine oil - change

---

Variable speed rollers - check or replacement

---

Driving belt - checking

---

Coolant level - check

---

Radiator - external cleaning/ check

---

Brake pads - check condition and wear

---

Brake fluid level - check

---

---

Electrical system and battery - check

---

Tyre pressure and wear - check

---

Vehicle and brake test - road test

---

**AT 24000 KM AND AT 48000 KM**

---

Engine oil - replacement

---

Hub oil - change

---

Air filter - clean

---

Engine oil - change

---

Spark plug - replacement

---

valve clearance - check

---

Idle speed (\*) - adjustment

---

Throttle lever - adjustment

---

Variable speed rollers - check or replacement

---

Driving belt - replacement

---

Coolant level - check

---

Steering - adjustment

---

Brake control levers - greasing

---

Brake pads - check condition and wear

---

Brake fluid level - check

---

Transmission elements - lubrication

---

Safety locks - check
----------------------

Suspensions - check
---------------------

Electrical system and battery - check
---------------------------------------

Headlight - adjustment
------------------------

Driven pulley roller casing - Greasing
--

Tyre pressure and wear - check
--------------------------------

Vehicle and brake test - road test
------------------------------------

(\*) See instructions in «Idle speed adjustment» section

### **AT 30000 KM, AT 42000 KM AND AT 66000 KM**

Hub oil level - check
-----------------------

Spark plug/ electrode gap - check
-----------------------------------

Air filter - clean
--------------------

Variable speed rollers - check or replacement
---

Driving belt - checking
-------------------------

Coolant level - check
-----------------------

Brake pads - check condition and wear
---------------------------------------

Brake fluid level - check
---------------------------

Electrical system and battery - check
---------------------------------------

Tyre pressure and wear - check
--------------------------------

Vehicle and brake test - road test
------------------------------------

---

Engine oil - replacement

---

Oil filter -Replacement

---

**AFTER 36000 KM**

---

Engine oil - replacement

---

Hub oil level - check

---

Air filter - clean

---

Engine oil - change

---

Spark plug - replacement

---

Idle speed (\*) - adjustment

---

Throttle lever - adjustment

---

Variable speed rollers - check or replacement

---

Driving belt - replacement

---

Coolant level - check

---

Radiator - external cleaning/ check

---

Steering - adjustment

---

Brake control levers - greasing

---

Brake pads - check condition and wear

---

Brake fluid hoses - replacement

---

Brake fluid level - check

---

Transmission elements - lubrication

---

---

Safety locks - check

---

Suspensions - check

---

Electrical system and battery - check

---

Headlight - adjustment

---

Driven pulley roller casing - Greasing

---

Tyre pressure and wear - check

---

Vehicle and brake test - road test

---

*(\*) See instructions in «Idle speed adjustment» section*

### **AFTER 72000 KM**

---

Engine oil - replacement

---

Hub oil - change

---

Spark plug / electrode gap - check / replacement

---

Air filter - clean

---

Engine oil - change

---

valve clearance - check

---

Idle speed (\*) - adjustment

---

Throttle lever - adjustment

---

Variable speed rollers - check or replacement

---

Driving belt - replacement

---

Coolant level - check

---

Radiator - external cleaning/ check
-------------------------------------

Steering - adjustment
-----------------------

Brake control levers - greasing
---------------------------------

Brake pads - check condition and wear
---------------------------------------

Brake fluid hoses - replacement
---------------------------------

Brake fluid level - check
---------------------------

Transmission elements - lubrication
-------------------------------------

Safety locks - check
----------------------

Suspensions - check
---------------------

Electrical system and battery - check
---------------------------------------

Headlight - adjustment
------------------------

Driven pulley roller casing - Greasing
--

Tyre pressure and wear - check
--------------------------------

Vehicle and brake test - road test
------------------------------------

(\*) See instructions in «Idle speed adjustment» section

### **EVERY 2 YEARS**

Coolant - change
------------------

Brake fluid - change
----------------------

Secondary air filter (external / internal) - Clean
--

**RECOMMENDED PRODUCTS TABLE**

<b>Product</b>	<b>Description</b>	<b>Specifications</b>
AGIP ROTRA 80W-90	Rear hub oil	SAE 80W/90 Oil that exceeds the requirements of API GL3 specifications
AGIP CITY HI TEC 4T	Oil to lubricate flexible transmissions (throttle control)	Oil for 4-stroke engines
AGIP FILTER OIL	Oil for air filter sponge	Mineral oil with specific additives for increased adhesiveness
AGIP GP 330	Calcium complex soap-based grease with NLGI 2; ISO-L-XBCIB2	Grease (brake control levers, throttle grip)
AGIP CITY HI TEC 4T	Engine oil	SAE 5W-40, API SL, ACEA A3, JASO MA Synthetic oil
AGIP BRAKE 4	Brake fluid	FMVSS DOT 4 Synthetic fluid
SPECIAL AGIP PERMANENT fluid	coolant	Monoethylene glycol-based antifreeze fluid, CUNA NC 956-16

## 6 Programmed maintenance



# TABLE OF CONTENTS

## **A**

Air filter: 41

## **B**

Battery: 46, 47

Brake: 45, 59

## **C**

Clock: 9

## **D**

Disc brake: 59

## **E**

Engine oil: 34–36

Engine stop: 12

## **F**

Fuel: 16

Fuses: 49

## **H**

Headlight: 55

Horn: 11

Hub oil: 37

## **I**

Identification: 18

Immobilizer: 12, 15

Instrument panel: 8

## **K**

Key switch: 9

Keys: 13

## **L**

Light switch: 11

## **M**

Maintenance: 33, 77, 78

Mirrors: 58

## **S**

Saddle: 17

Scheduled maintenance: 78

Shock absorbers: 25

Spark plug: 40

Stand: 29

Start-up: 12

## **T**

Tank: 16

Technical Data: 67

Top box: 19

Transmission: 29

Turn indicators: 57

Tyre pressure: 24

Tyres: 39



The descriptions and illustrations given in this publication are not binding. While the basic specifications as described and illustrated in this booklet remain unchanged, PIAGGIO-GILERA reserves the right, at any time and without being required to update this publication beforehand, to make any changes to components, parts or accessories, which it considers necessary to improve the product or which are required for manufacturing or construction reasons.

Not all versions/models shown in this publication are available in all countries. The availability of single models should be checked at the official Piaggio sales network.

"© Copyright 2008 - PIAGGIO & C. S.p.A. Pontedera. All rights reserved. Reproduction of this publication in whole or in part is prohibited."

PIAGGIO & C. S.p.A. - After-Sales

V.le Rinaldo Piaggio, 23 - 56025 PONTEDERA (Pi)