

Vespa would like to thank you

for choosing one of its products. We have prepared this manual to help you to get the very best from your vehicle. Please read it carefully before riding the vehicle for the first time. It contains information, tips and precautions for using your vehicle. It also describes features, details and devices to assure you that you have made the right choice. We believe that if you follow our suggestions, you will soon get to know your new vehicle and it will serve you well for a long time to come. This booklet forms an integral part of the vehicle; should the vehicle be sold, it must be transferred to the new owner.

Vespa GTS 300 I.E.



The instructions given in this booklet are intended to provide a clear, simple guide to using your scooter; details are also given of routine maintenance procedures and regular checks that should be carried out on the vehicle at and **Authorized PIAGGIO Dealer or Service Centre**. The booklet also contains instructions for simple repairs. Any operations not specifically described in this booklet require the use of special tools and/or particular technical knowledge: to carry out these operations refer to any **authorized PIAGGIO Dealer of Service Centre**.



Personal safety

Failure to completely observe these instructions will result in serious risk of personal injury.



Safeguarding the environment

Sections marked with this symbol indicate the correct use of the vehicle to prevent damaging the environment.



Vehicle intactness

The incomplete or non-observance of these regulations leads to the risk of serious damage to the vehicle and sometimes even the invalidity of the guarantee.

The signs that you see on this page are very important. They are used to highlight parts of the booklet that should be read with particular care. The different symbols are used to make each topic in the manual simple and quick to locate.

INDEX

VEHICLE	7	Automatic transmission.....	33
Dashboard.....	9	Safe driving.....	34
Analogue instrument panel.....	10	MAINTENANCE	37
Clock.....	11	Engine oil level.....	38
Key switch.....	12	Engine oil level check.....	38
Locking the steering wheel.....	12	Engine oil top-up.....	38
Releasing the steering wheel.....	12	Warning light (insufficient oil pressure).....	39
Switch direction indicators.....	13	Engine oil change.....	39
Horn button.....	13	Hub oil level.....	40
Light switch.....	14	Tyres.....	42
Start-up button.....	14	Spark plug dismantlement.....	43
Engine stop button.....	15	Removing the air filter.....	44
The immobilizer system.....	15	Cooling fluid level.....	46
Keys.....	15	Checking the brake oil level.....	47
Immobilizer device enabled indicator led.....	16	Battery.....	49
Operation.....	17	Use of a new battery.....	50
Programming the immobilizer system.....	18	Long periods of inactivity.....	50
Accessing the fuel tank.....	19	Fuses.....	51
Opening the saddle.....	20	Front light group.....	56
Identification.....	21	Headlight adjustment.....	58
Rear top box opening.....	22	Front direction indicators.....	59
Bag clip.....	23	Rear optical unit.....	59
USE	25	Rear turn indicators.....	60
Checks.....	26	Rear-view mirrors.....	60
Refuelling.....	26	Front and rear disc brake.....	60
Tyre pressure.....	28	Puncture.....	61
Shock absorbers adjustment.....	29	Periods of inactivity.....	62
Running in.....	30	Cleaning the vehicle.....	63
Starting up the engine.....	30	TECHNICAL DATA	69
Precautions.....	31	Toolkit.....	74
Difficult start up.....	32	SPARE PARTS AND ACCESSORIES	75
Stopping the engine.....	32	Warnings.....	76
Stand.....	33	SCHEDULED MAINTENANCE	79

Scheduled servicing table..... 80

Vespa GTS 300 I.E.

Vespa®



**Chap. 01
Vehicle**

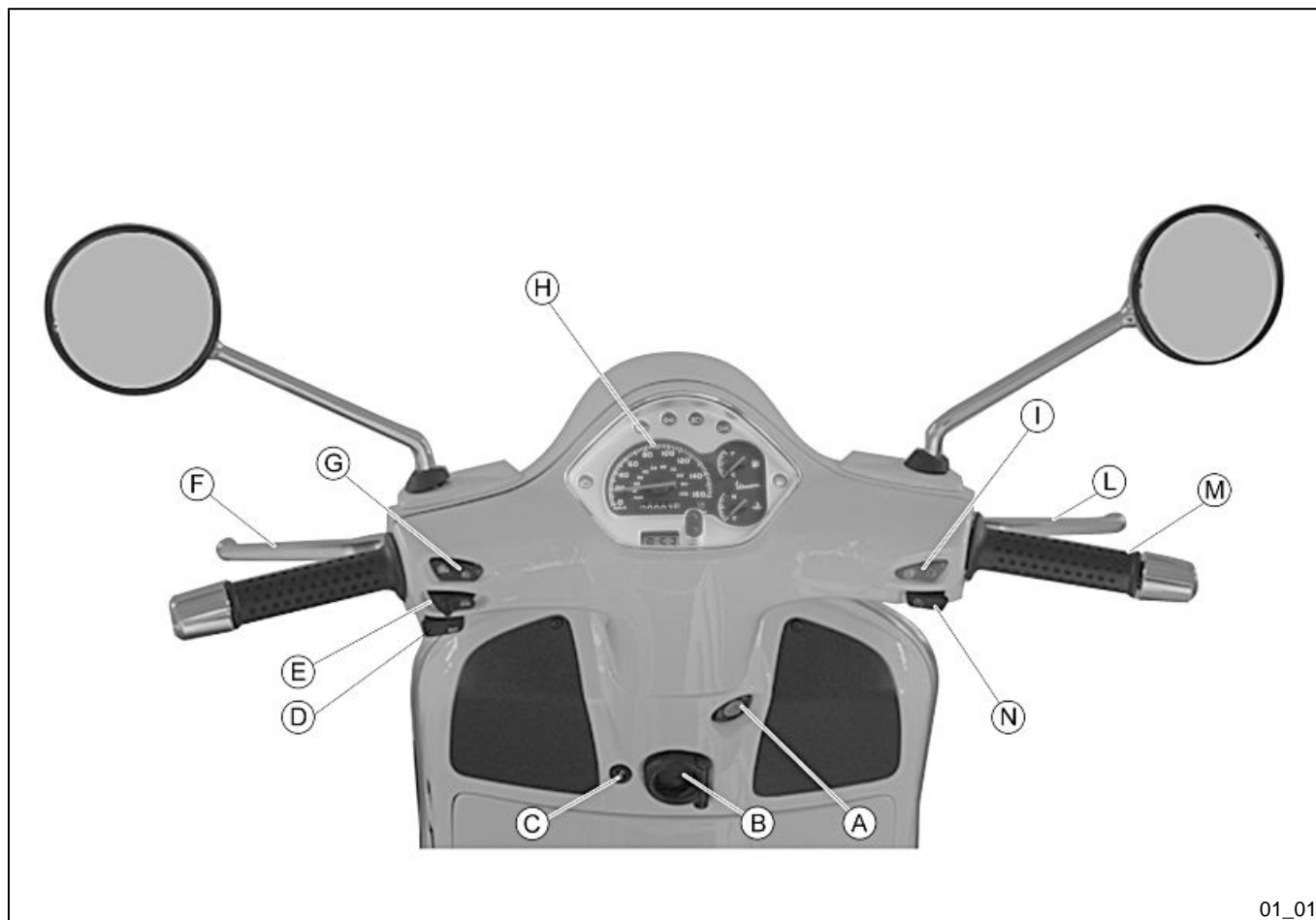

Dashboard (01_01)

A = Ignition key-switch

B = Bag hook

C = Saddle electric opening switch

D = Horn button

E = Turn indicator switch

F = Rear brake lever

G = Light switch

H = Instrument panel

I = Emergency cut-off switch RUN/OFF

L = Front brake lever

M = Throttle grip

N = Starter button

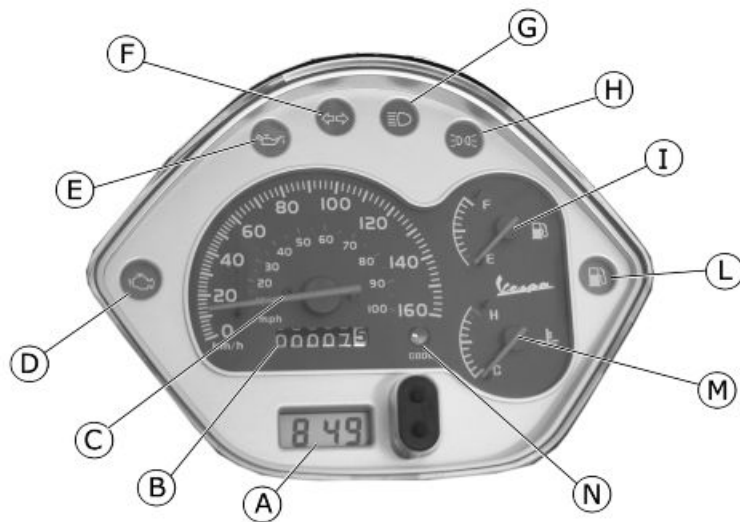

01_02

Analogue instrument panel (01_02)

- A = Digital clock
- B = Odometer
- C = Speedometer
- D = Injection warning light
- E = Engine oil pressure warning light
- F = Turn indicators
- G = High-beam warning light

H = Headlight warning light

I = Fuel gauge

L = Low fuel warning light

M = Coolant temperature gauge

N = Immobilizer LED

Clock (01_03)

Located in the instrument panel, it displays hours and minutes with 1 to 12-hour time, AM or PM.

Operate the function selection button «**B**» and month, day and seconds are also displayed besides hours and minutes.

To adjust the different functions, select the desired function with button «**A**» and adjust with button «**B**». The time counter can be reset by pressing button «**A**» with the clock in the seconds function.

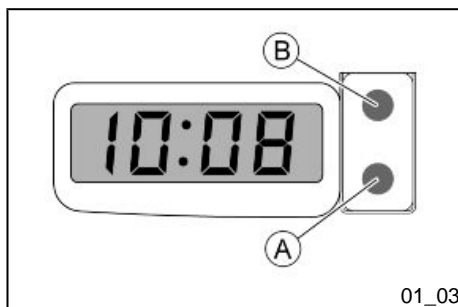

The digital clock is powered by a battery (battery life is about 2 years); lift the whole instrument panel to replace the battery. It is advisable to take your vehicle to an **Authorised Service Centre** for this operation.

WARNING



DEAD BATTERIES ARE HARMFUL TO THE ENVIRONMENT. THEY MUST DISPOSED OF IN SUITABLE CONTAINERS AS PRESCRIBED BY THE REGULATIONS IN FORCE.

Key switch (01_04)

Ignition key «A» is located on the front leg shield back plate near the bag hook.

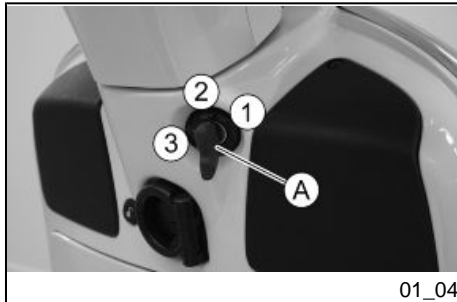

SWITCH POSITIONS

ON «1»: Ready to start position, non-extractable key, mechanical antitheft device disabled.

OFF «2»: Ignition disabled, extractable key, mechanical antitheft device disabled.

LOCK «3»: Ignition disabled, extractable key, mechanical antitheft device enabled.

Locking the steering wheel

Turn the handlebar to the left (as far as it will go), turn the key to «**LOCK**» and remove the key.

CAUTION



DO NOT TURN THE KEY TO «LOCK» OR «KEY OFF» WHILE RIDING.

Releasing the steering wheel

Reinsert the key and turn it to «**OFF**».

CAUTION

DO NOT TURN THE KEY TO «LOCK» OR «KEY OFF» WHILE RIDING.

Switch direction indicators (01_05)

Move switch «E» to the left to indicate a left turn; move switch «E» to the right to indicate a right turn. Push the central part of switch «E» to deactivate the turn indicators.

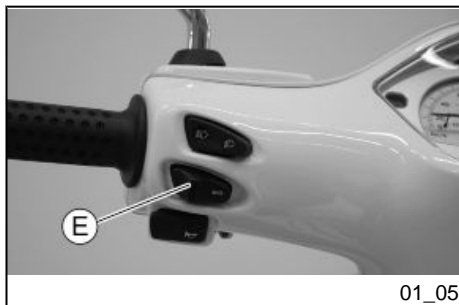
**Horn button (01_06)**

Push the button «D» to sound the horn.

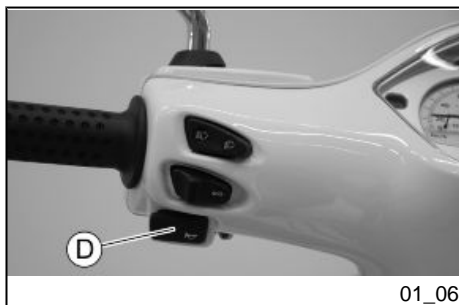

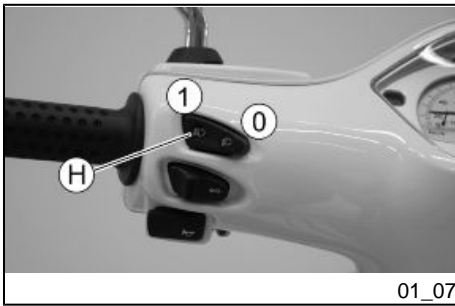

Light switch (01_07)

When the light switch «H» is set to «0», the low-beam light is on. When set to «1», the high-beam light is activated.

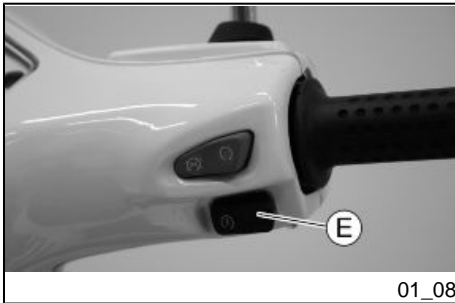

Start-up button (01_08)

Starter button «E»

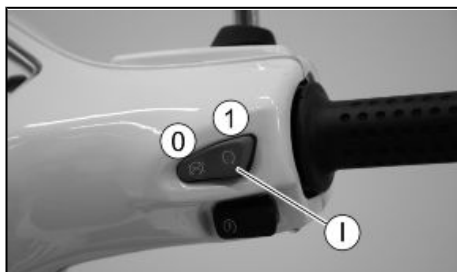

01_09

Engine stop button (01_09)

The engine can be started when the emergency cut-off switch «I» is set to «1» **RUN**; if the emergency cut-off switch «I» is set to «0» **OFF**, the engine cannot be started, or it shuts off if already running.

The immobilizer system

In order to enhance theft protection, the vehicle is equipped with a «**PIAGGIO IMMOBILIZER** » electronic engine locking device that is activated automatically when the ignition switch is removed. Upon start-up, the «**PIAGGIO IMMOBILIZER**» system checks the starter key, and only if this key is recognised will the Immobiliser system allow the vehicle to be started.

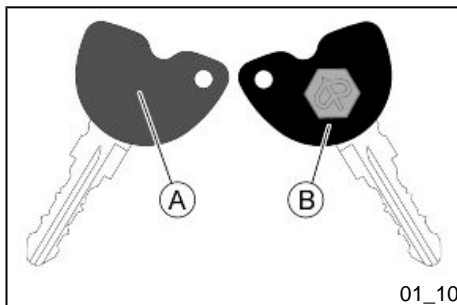

01_10

Keys (01_10, 01_11, 01_12)

Two types of keys are supplied together with the vehicle.

Key «A» is the «**MASTER**» key.

Only a single copy of this key is supplied, which is necessary to program all your other keys and for your dealer to perform some maintenance operations. For this reason it is advised that it be used only in exceptional circumstances.

The key «B» (single copy supplied) is used for regular operations such as:

- Engine start-up.

Together with the two keys, you will be given a CODE CARD bearing the same code imprinted onto the two keys.

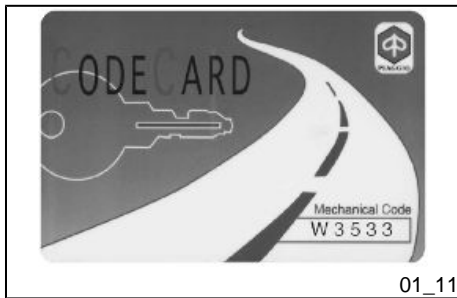
**WARNING**

LOSING THE MASTER KEY PREVENTS ANY FURTHER REPAIR OF THE "PIAGGIO IMMOBILISER" SYSTEM AND OF THE ENGINE CONTROL UNIT.

WARNING

KEEP THE "CODE CARD" AND THE MASTER KEY IN A SAFE PLACE (NOT IN THE VEHICLE).

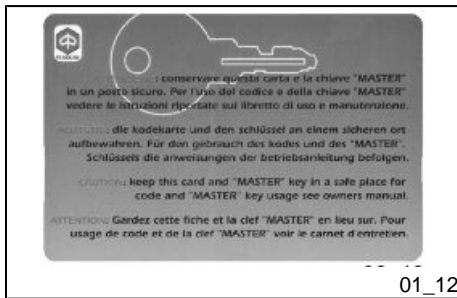
**Immobilizer device enabled indicator led (01_13)**

The activation of the «PIAGGIO IMMOBILIZER» system is signalled by the a flashing indicator «N».

In order to reduce battery discharge, the indicator LED turns off automatically after 48 hours of uninterrupted functioning.

Should the system fail, different LED flashing patterns will provide the **Authorised Service Centre** with information on the type of fault detected.



Operation

Each time the ignition key «**B**» is removed while in the «**OFF**» or «**LOCK**» positions, the protection system activates the engine lock. Turning the ignition key «**B**» to «**ON**» disables the engine lock, provided that the safety system recognises the code transmitted by the key. If the code is not recognised, turn the ignition key «**B**» first to «**OFF**» and then back to «**ON**» again; if lock persists, try again using the «**A**» MASTER key. If the engine cannot be started, contact an **Authorised Service Centre**, which is provided with the electronic equipment required to detect and repair the system.

When the supplementary starter keys are required, remember that the all the keys, whether new or existing, should be programmed.

Contact an **Authorised Service Centre** and bring the «**A**» MASTER key and all «**B**» starter keys that you own.

The codes of starter keys not submitted for the new programming procedure are deleted from the memory. Any lost starter keys will therefore not be enabled to start the engine.

WARNING



EACH KEY HAS ITS OWN AND UNIQUE CODE, WHICH MUST BE STORED IN THE SYSTEM CONTROL UNIT MEMORY.

VIOLENT SHOCKS MAY AFFECT THE ELECTRONIC COMPONENTS OF THE KEY.

IF THE VEHICLE IS SOLD, THE MASTER-HANDGRIP KEY (AS WELL AS THE OTHER STARTER KEYS) AND THE «CODE CARD» MUST ALSO BE TRANSFERRED TO THE NEW OWNER.

Programming the immobilizer system (01_14)

Below is described the procedure to follow for programming the **PIAGGIO IMMOBILIZER** system and/or for storing other key codes. The programming procedure should be carried out with the engine stop switch set to **«RUN»**.

START PROCEDURE

Insert the **«MASTER»** key **«A»** into the ignition switch (in **«OFF»**) and turn it to **«ON»**. After 1 - 3 seconds, turn the key to **«OFF»** again and pull it out.

INTERMEDIATE STAGE

After extracting the **«MASTER»** key **«A»**, insert, within ten seconds, the key that is going to be programmed **«B»** and turn it immediately to **«ON»**. After 1-3 seconds, turn the key to **«OFF»** again and pull it out. In this way, a maximum of 7 keys can be programmed by repeating the above procedure and keeping the indicated times.

FINAL STAGE

After extracting the key to be programmed **«B»**, insert the **«MASTER»** key **«A»** again and turn it to **«ON»** (perform this operation within the 10 seconds following the extraction of the previous key). Leave it in this position for 1 to 3 seconds and return it to **«OFF»**.

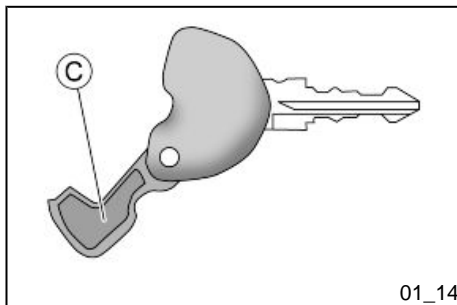

01_14

CORRECT PROGRAMMING CHECK PHASE

Insert the «MASTER» key «A» disabling the transponder «C» (i.e., by tilting the key cap by 90°), and turn the key to «ON». Perform the engine starter operation. Ensure that the engine does not start. Insert the programmed key «B» and repeat the starter operation. Check that engine starts.

WARNING



SHOULD YOU START THE ENGINE WITH THE MASTER KEY (WITH TRANSPONDER OFF) OR IN THE EVENT OF WRONG OPERATION DURING PROGRAMMING, REPEAT THE PROCEDURE FROM THE BEGINNING.

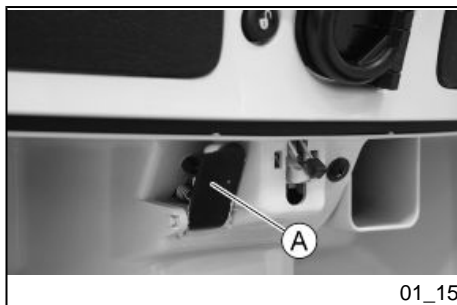

01_15

Accessing the fuel tank (01_15, 01_16)

With the key set to «OFF» or «ON», or with engine on, it is possible to electrically open the saddle by pressing the button «C». If the saddle opening system does not work, operate the emergency lever «A».

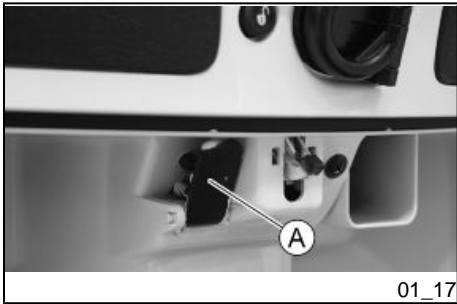
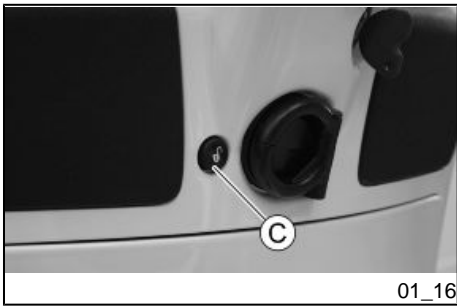

Opening the saddle (01_17, 01_18)

With the key set to «OFF» or «ON», or with engine on, it is possible to electrically open the saddle by pressing button «C». If the electric opening does not work, use the emergency lever "A". When the key is set to «LOCK» the saddle cannot be opened.

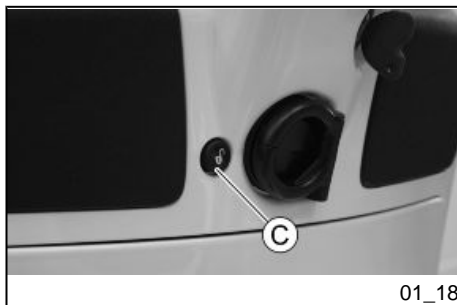

01_18

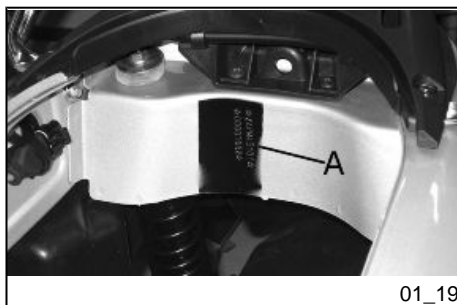

01_19

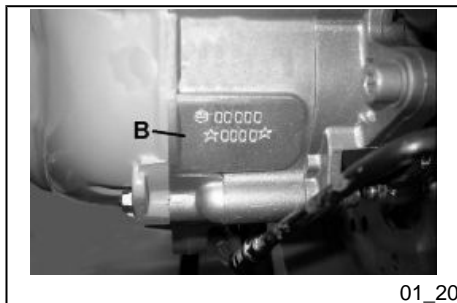

01_20

Identification (01_19, 01_20, 01_21)

The identification registration numbers consist of a prefix followed by a number stamped on both the chassis «A» and the engine «B». These numbers must always be indicated on spare parts requests. To read the chassis number, lift the saddle and remove the helmet compartment «C». We recommend checking that the chassis registration number stamped on the vehicle corresponds with that on the vehicle documentation.

CAUTION



BE REMINDED THAT ALTERING IDENTIFICATION REGISTRATION NUMBERS CAN LEAD TO SERIOUS PENAL SANCTIONS (IMPOUNDING OF THE VEHICLE, ETC.).

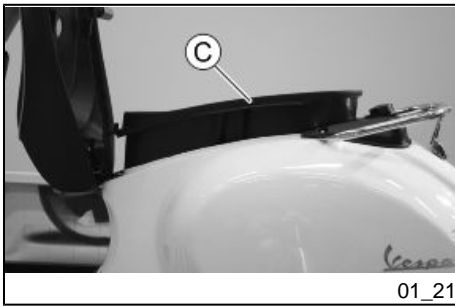

Rear top box opening (01_22)

Insert the key into the switch and press down until the glove compartment opens. If the switch is set to "**LOCK**", turn the key to "**OFF**" or "**ON**" before pressing it down.



Bag clip (01_23)

To use the retractable bag hook «**B**» mounted on the leg shield back plate, pull it slightly towards the back of the vehicle.

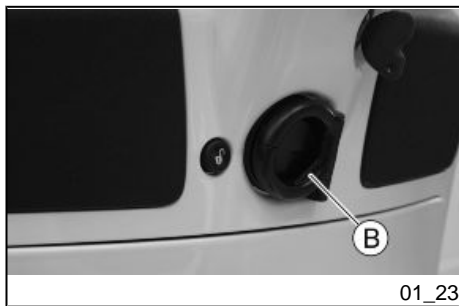

Vespa GTS 300 I.E.

Vespa®



Chap. 02
Use

Checks

Before using the vehicle, check:

1. That there is enough fuel in the fuel tank.
2. That the fluid level for front and rear brakes is correct.
3. That tyres are properly inflated.
4. The correct functioning of daylight running lights, headlamp, turn indicators, stop light and license plate light.
5. The correct functioning of front and rear brakes.
6. The oil level in the gearcase.
7. Engine oil level.
8. The coolant level.

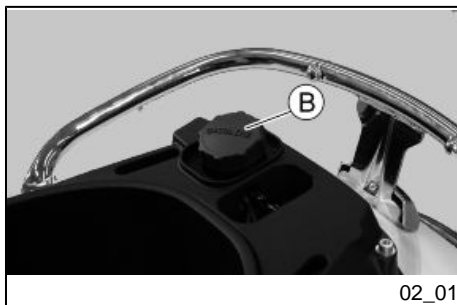

02_01

Refuelling (02_01, 02_02)

Fuel: lift the saddle and unscrew the cap «B». Recommended fuel: Unleaded petrol, min octane rating of 95. The fuel reserve level is signalled when the warning light «L» turns on.

WARNING



SWITCH OFF THE ENGINE BEFORE REFUELLING WITH PETROL.

PETROL IS HIGHLY INFLAMMABLE.

DO NOT SMOKE AND KEEP NAKED FLAMES AT A DISTANCE: FIRE HAZARD.

DO NOT INHALE FUEL FUMES.

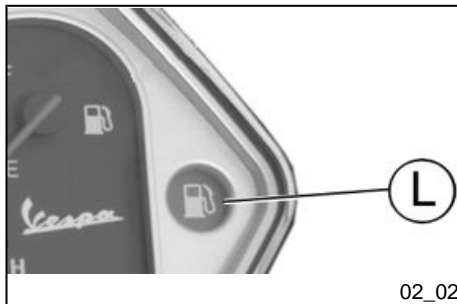

DO NOT ALLOW PETROL TO COME INTO CONTACT WITH HOT ENGINE OR ANY PLASTIC PARTS.

CAUTION



PETROL DAMAGES THE PLASTIC PARTS OF THE BODYWORK.

CAUTION



USING OILS OTHER THAN THOSE RECOMMENDED CAN SHORTEN THE LIFE OF THE ENGINE.

CAUTION



DO NOT USE THE VEHICLE TO THE COMPLETE EXHAUSTION OF THE FUEL; SHOULD THIS OCCUR, DO NOT ATTEMPT TO START THE ENGINE. TURN THE IGNITION SWITCH TO «OFF» AND TOP-UP THE TANK AS SOON AS POSSIBLE. FAILURE TO FOLLOW THESE GUIDELINES COULD DAMAGE THE FUEL PUMP AND/OR THE CATALYTIC CONVERTER.

Characteristic

Fuel tank capacity

~ 9.2 litres

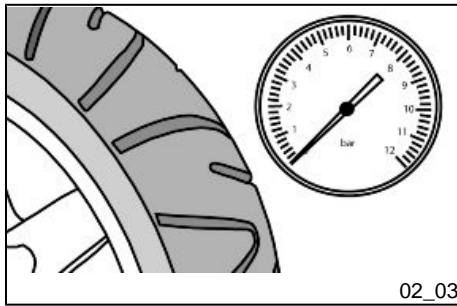

Tyre pressure (02_03)

Check tyre pressure and wear periodically (roughly every 500 km). Tyres feature wear indicators; replace tyres as soon as these indicators become visible on the tyre tread. Also check that the tyres do not show signs of splitting at the sides or irregular tread wear; if this occurs, go to an authorised workshop or at least to a workshop equipped to replace tyres.

CAUTION



TYRE PRESSURE SHOULD BE CHECKED WHEN TYRES ARE COLD. INCORRECT TYRE PRESSURE CAUSES ABNORMAL TYRE WEAR AND MAKES RIDING DANGEROUS.

TYRES MUST BE REPLACED WHEN THE TREAD REACHES THE WEAR LIMITS SET FORTH BY LAW.

TYRES

Front tyre	120/70 - 12" 51P Tubeless
Rear tyre	Tubeless 130/70 12" 62P

TYRE INFLATION PRESSURE

Front tyre pressure (with passenger)	1.8 bar (-)
Rear tyre pressure (with passenger)	2.2 bar (-)

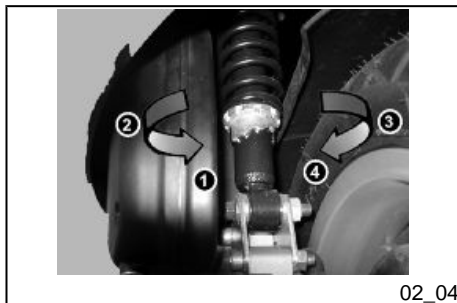

02_04

Shock absorbers adjustment (02_04)

The preloading of the springs can be adjusted to 4 positions acting on the ring nut located in the lower part of the shock absorbers with the specific spanner supplied.

Position 1: minimum preload: rider only

Position 2 medium preloading: rider only

Position 3 medium preloading: rider and passenger

Position 4: maximum preloading: rider, passenger, and luggage.

In order to carry out this operation you will need to use the specific spanner in the kit.

CAUTION



RIDING THE VEHICLE WITH THE SPRING PRELOADING NOT CORRECTLY SET FOR THE RIDER AND POSSIBLE PASSENGER, COULD REDUCE THE COMFORT OF THE RIDE AND THE PRECISION OF THE STEERING.

WARNING



WE RECOMMEND WEARING GLOVES WHILE CARRYING OUT THIS OPERATION IN ORDER TO AVOID INJURIES.

WARNING



IT IS ABSOLUTELY FORBIDDEN TO ADJUST THE PRELOAD DIFFERENTLY ON THE TWO SHOCK ABSORBERS

Running in

WARNING



DURING THE FIRST 1000 KM DO NOT RIDE THE VEHICLE OVER 80% OF ITS MAXIMUM SPEED. AVOID TWISTING THE THROTTLE GRIP FULLY OR KEEPING A CONSTANT SPEED ALONG LONG SECTIONS OF ROAD. AFTER THE FIRST 1000 KM, GRADUALLY INCREASE SPEED UNTIL REACHING THE MAXIMUM PERFORMANCE.

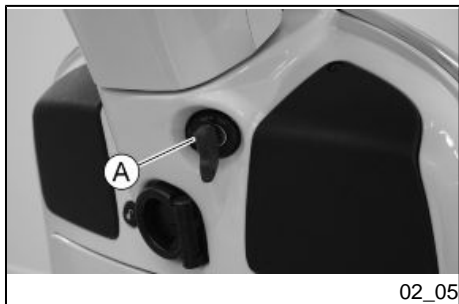

Starting up the engine (02_05, 02_06)

To start the engine it is necessary, before pressing the starter button, to pull and keep pulled the front or rear brake lever, which activates the appropriate switch allowing start-up.

1. Rest the vehicle on its centre-stand, ensuring the rear wheel is not touching the ground.
2. Maintain the throttle grip «E» completely untwisted.
3. Insert the key into the ignition switch «A» and turn it to «ON».
4. Make sure that the «B» switch is set to «RUN».
5. Pull lever «C» of the front or rear brake and then activate the starter button «D».

WARNING



THE AUTOMATIC TRANSMISSION MAKES THE REAR WHEEL TURN EVEN WHEN THE THROTTLE GRIP IS SLIGHTLY TWISTED. RELEASE THE BRAKE CAREFULLY AFTER STARTING, AND THEN ACCELERATE GRADUALLY.

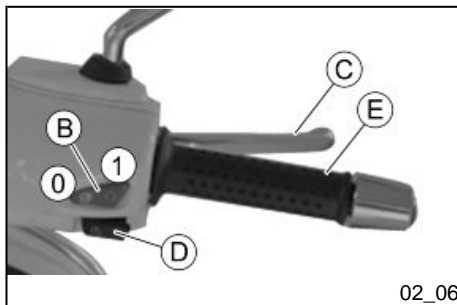

02_06

CAUTION

DO NOT START-UP THE ENGINE IN CLOSED AREAS BECAUSE EXHAUST GASES ARE TOXIC.

Precautions**CAUTION**

NEVER STRESS THE ENGINE AT LOW TEMPERATURES IN ORDER TO AVOID POSSIBLE DAMAGE. BE CAREFUL NEVER TO EXCEED THE MAXIMUM SPEED WHILE RUNNING DOWNHILL, IN ORDER TO AVOID DAMAGING THE ENGINE. IN ANY CASE, IN ORDER TO PRESERVE THE ENGINE FROM PROLONGED OVERREVVING, THE REVOLUTION LIMITER WILL BE ACTIVATED IF THE ENGINE SPEED EXCEEDS THE ESTABLISHED THRESHOLD.

WARNING

AFTER A LONG DISTANCE COVERED AT THE MAXIMUM SPEED, DO NOT STOP THE ENGINE IMMEDIATELY, BUT LET IT RUN AT IDLE FOR A FEW SECONDS.

Difficult start up

In the rare case of engine flooding, to facilitate start-up, it is possible to try to put the vehicle into action with the gas hand grip partially or completely open. It is however necessary, once the engine is started, to take your vehicle to an **Authorised Service Centre** to determine the cause of this problem and to re-establish the vehicle proper functioning.

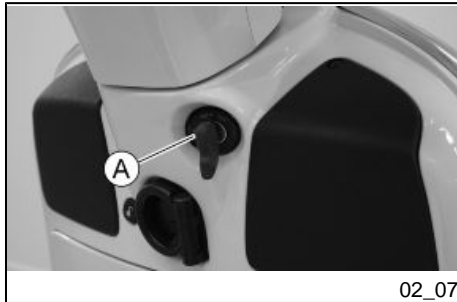

Stopping the engine (02_07, 02_08)

Fully untwist the throttle grip and then turn the switch key «A» to «OFF» (extractable key), or turn the switch «B» to «OFF».

CAUTION



DUE TO THE HIGH TEMPERATURES THE CATALYTIC CONVERTER CAN REACH, ALWAYS TAKE CARE, WHEN PARKING THE VEHICLE, THAT THE EXHAUST DOES NOT COME INTO CONTACT WITH FLAMMABLE MATERIALS, TO AVOID SERIOUS BURNS.

CAUTION



DO NOT SHUT OFF THE ENGINE WHILE THE VEHICLE IS MOVING. UNBURNED FUEL COULD ENTER THE CATALYTIC CONVERTER AND BURN, CAUSING THE CONVERTER TO OVERHEAT AND POSSIBLY DESTROYING IT.

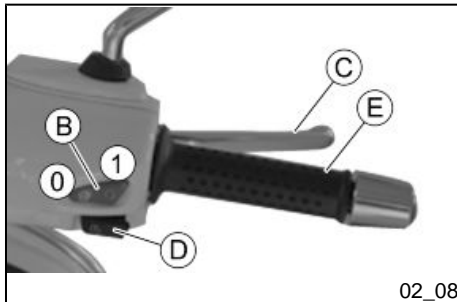

Stand (02_09)

CENTRE STAND

Push with your foot on the centre stand's fork "F" while lifting the vehicle backward, holding onto the handlebar.

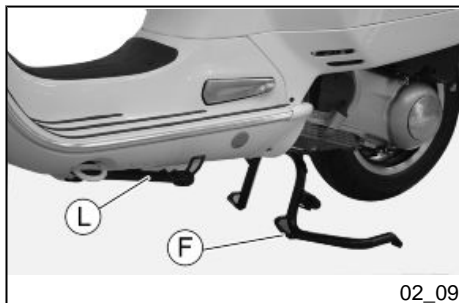

SIDE STAND

With your foot push the projection of the stand «L » in order to open it and at the same time lean the vehicle on you.

Automatic transmission

To ensure simple, pleasurable riding, the vehicle is equipped with automatic transmission with regulator and centrifugal clutch. The system is designed to provide the best performance (acceleration and consumption) while driving on both flat roads and uphill.

If you have to stop up a hill (traffic lights, traffic jam, etc.) **use only the brake to keep the vehicle still, leaving the engine running at idle speed. Using the engine to keep the vehicle still can cause the clutch to overheat, due to the friction of the clutch mechanism itself against the capstan.**

It is therefore recommended to avoid conditions of prolonged clutch slippage (other than those previously indicated) like driving uphill fully laden on steep slopes or starting off with driver and passenger at slopes greater than 25%.

Take the following precautions if the clutch overheats:

1. Do not continue riding in such conditions.
2. Let the clutch cool down with the engine at idle speed for a few minutes.

Safe driving (02_10)

WARNING



SOME SIMPLE TIPS ARE PROVIDED BELOW WHICH WILL ENABLE YOU TO USE YOUR VEHICLE ON A DAILY BASIS MORE EASILY AND SAFELY.

<



Your ability and your knowledge of the vehicle form the basis of safe riding. We recommend trying out the vehicle in traffic-free zones to get to know your vehicle completely.

ALWAYS DRIVE WITHIN YOUR LIMITS

1. Before riding off, remember to put on your helmet and fasten it correctly.
2. Reduce speed and ride cautiously on uneven roads.
3. Remember that after riding on a long stretch of wet road without using the brakes, the braking effect is initially lower. Under these conditions, it is a good idea to operate the brakes from time to time.
4. Do not brake hard on a wet surface, on dirt tracks or on any slippery road surface.
5. If you have to brake, use both brakes in order to divide the braking action between both wheels.
6. Avoid starting off by mounting the vehicle while it is still resting on its stand. In any case, the rear wheel should not be turning when it comes into contact with the ground, in order to avoid abrupt departures.

7. If the vehicle is used on roads covered with sand, mud, snow mixed with salt, etc., clean the brake disc frequently with mild detergent in order to prevent abrasive substances from building up within the holes, which can result in early wear of the brake pads.

8. Any elaboration that modifies the vehicle's performances, such as tampering with original structural parts is strictly forbidden by law, and renders the vehicle not conforming to the approved type and therefor dangerous to ride.

CAUTION

RIDING UNDER THE INFLUENCE OF ALCOHOL, DRUGS OR CERTAIN MEDICINES CAN BE EXTREMELY DANGEROUS FOR ONESELF AND FOR OTHERS.

CAUTION

ANY ELABORATION THAT MODIFIES THE VEHICLE'S PERFORMANCES, SUCH AS TAMPERING WITH ORIGINAL STRUCTURAL PARTS IS STRICTLY FORBIDDEN BY LAW, AND RENDERS THE VEHICLE NO LONGER CONFORMING TO THE APPROVED TYPE AND DANGEROUS FOR RIDING.

Vespa GTS 300 I.E.



Chap. 03 Maintenance

Engine oil level

Four stroke engine oil is used in the engines in order to lubricate the timing bodies, the bench bearings and the thermal group. **An insufficient quantity of oil can seriously damage the engine.** In all four-stroke engines, a loss of efficiency in oil performance and certain consumption should be considered normal. Consumption can particularly reflect the conditions of use (i.e. when driving at 'full acceleration' all the time, oil consumption increases). The replacement intervals provided for by the maintenance programme are defined depending on the total content of oil in the engine and the average consumption measured following standardised methods. **In order to prevent any problems, we recommend checking oil level more frequently than indicated in the Scheduled Maintenance table or before setting off on long journeys. The vehicle is, however, equipped with an oil pressure warning light on the instrument panel.**

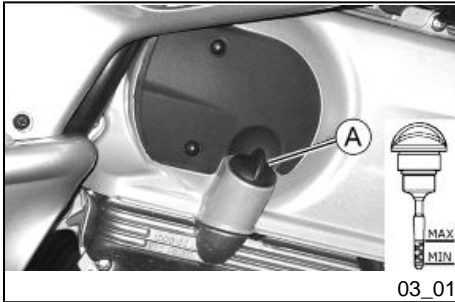

Engine oil level check (03_01)

Every time the scooter is used, a visual check should be made on the level of the engine oil when the engine is cold. The oil level should be somewhere between the **MAX** and **MIN** index marks on the level bar; the check must be made with the scooter upright, resting on the centre stand. If the check is carried out after the vehicle has been used, and therefore with a hot engine, the level line will be lower; in order to carry out a correct check, wait at least 10 minutes after the engine has been stopped so as to get the correct level.

Engine oil top-up

Always check the oil level before topping up, and add oil **without exceeding the MAX** level. Getting an oil level between the **MIN** and **MAX** levels requires ~ 400 cm³ of oil. Take your vehicle to an **Authorised Service Centre** to have the oil checked and if necessary, topped-up as indicated in the scheduled maintenance table.

Warning light (insufficient oil pressure)

The vehicle is equipped with a warning light that comes on when the key is turned to «ON». However, this light should come off once the engine has been started. **If the light comes on while braking, at idle speed or while turning a corner, it is necessary to check the oil level and top it up if required. If after having topped-up the oil, the warning light still comes on while braking, at idle speed or while turning a corner, it will be necessary to take your vehicle to an Authorised Service Centre.**

Engine oil change (03_02)

Have oil changed and the cartridge filter «C» replaced as indicated in the scheduled maintenance table at an **Authorised Service Centre**. The engine should be emptied by draining the oil through drainage plug «B» of the mesh filter on the flywheel side. In order to facilitate the oil drainage, loosen the cap/dipstick. Since a certain quantity of oil still remains in the circuit, add approx. 950 ÷ 1000 cm³ of oil through the cap «A». Then start the engine, leave it running for a few minutes and shut it off: after 5 minutes, check the level and if necessary, top-up **without exceeding the MAX level**. The cartridge filter must be replaced at every oil change. For top-ups and changes, use new oil of the recommended type.

WARNING



RUNNING THE ENGINE WITH INSUFFICIENT LUBRICATION OR WITH INADEQUATE LUBRICANTS ACCELERATES THE WEAR AND TEAR OF THE MOVING PARTS AND CAN CAUSE IRREVERSIBLE DAMAGE.

WARNING



EXCESSIVE OIL LEVEL TOP-UPS CAN LEAD TO INCRUSTATIONS AND VEHICLE MALFUNCTIONING.

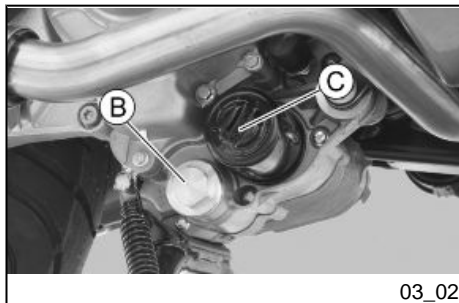

03_02

CAUTION

USED OILS CONTAIN SUBSTANCES HARMFUL TO THE ENVIRONMENT. FOR OIL REPLACEMENT, CONTACT AN AUTHORISED SERVICE CENTRE, WHICH IS EQUIPPED TO DISPOSE OF USED OILS IN AN ENVIRONMENTALLY FRIENDLY AND LEGAL WAY.

CAUTION

THE USE OF OIL OTHER THAN THAT RECOMMENDED CAN SHORTEN THE LIFE OF THE ENGINE.

Recommended products

AGIP CITY HI TEC 4T

Engine oil

SAE 5W-40, API SL, ACEA A3, JASO MA Synthetic oil



03_03

Hub oil level (03_03, 03_04)

Check the oil in the rear hub. To check the rear hub oil level, proceed as follows:

- 1) Park the scooter on level ground and rest it on its stand.
- 2) Unscrew dipstick «A», wipe it clean with a cloth, reinsert it and **tighten completely**.
- 3) Pull out the dipstick and check that the oil level is above the first notch from the bottom.
- 4) Reinsert the dipstick and ensure that it is tightened correctly.

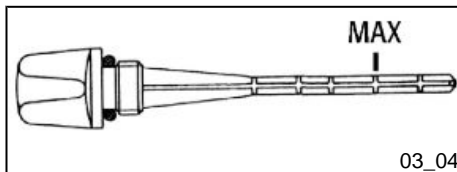

N.B.

THE NOTCHES ON THE HUB OIL LEVEL DIPSTICK, EXCEPT THE ONE INDICATING THE MAX LEVEL, REFER TO OTHER MODELS BY THE MANUFACTURER AND HAVE NO SPECIFIC FUNCTION FOR THIS MODEL.

CAUTION



RIDING THE VEHICLE WITH INSUFFICIENT HUB LUBRICATION OR WITH CONTAMINATED OR IMPROPER LUBRICANTS ACCELERATES THE WEAR AND TEAR OF THE MOVING PARTS AND CAN CAUSE SERIOUS DAMAGE.

CAUTION



USED OIL CAN HARM THE ENVIRONMENT. COLLECTION AND DISPOSAL SHOULD BE CARRIED OUT IN COMPLIANCE WITH REGULATIONS IN FORCE.

CAUTION



AN EXCESSIVE QUANTITY OF OIL CAN LEAD TO SPILL OVER, WHICH MAY CAUSE THE ENGINE AND THE WHEEL TO GET DIRTY.

CAUTION



WHEN REPLACING THE HUB OIL DO NOT LET THE OIL COME INTO CONTACT WITH THE REAR BRAKE DISC.

CAUTION

FOR OIL REPLACEMENT, CONTACT ANY AUTHORISED SERVICE CENTRE AS THEY ARE EQUIPPED TO DISPOSE OF USED OILS IN AN ENVIRONMENTALLY FRIENDLY AND LEGAL WAY.

Recommended products**AGIP ROTRA 80W-90***Rear hub oil*

SAE 80W/90 Oil that exceeds the requirements of API GL3 specifications

Characteristic**Rear hub oil**

250 cc

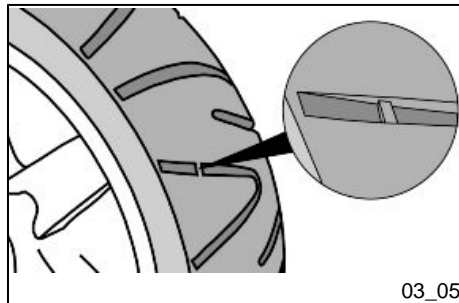
**Tyres (03_05)**

Check tyre pressure and wear periodically (roughly every 500 km). Tyres feature wear indicators; replace tyres as soon as these indicators become visible on the tyre tread. Also check that the tyres do not show signs of splitting at the sides or irregular tread wear; if this occurs, go to an authorised workshop or at least to a workshop equipped to replace tyres.

CAUTION

TYRE PRESSURE SHOULD BE CHECKED WHEN TYRES ARE COLD. INCORRECT TYRE PRESSURE CAUSES ABNORMAL TYRE WEAR AND MAKES RIDING DANGEROUS.

TYRES MUST BE REPLACED WHEN THE TREAD REACHES THE WEAR LIMITS SET FORTH BY LAW.

TYRES

Front tyre	120/70 - 12" 51P Tubeless
Rear tyre	Tubeless 130/70 12" 62P

TYRE INFLATION PRESSURE

Front tyre pressure (with passenger)	1.8 bar (-)
Rear tyre pressure (with passenger)	2.2 bar (-)

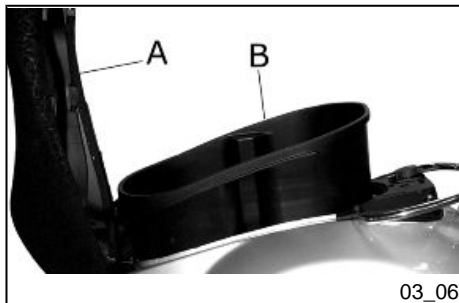

Spark plug dismantlement (03_06, 03_07)

Proceed as follows:

1. Lift the saddle «**A**».
2. Lift the helmet compartment «**B**» and reach into the spark plug with your hand.
3. Disconnect the cap of the spark plug HV wire «**C**».
4. Unscrew the spark plug using the wrench supplied.
5. Upon refitting, place the spark plug in the hole at the due inclination and finger tighten it as far as it will go.

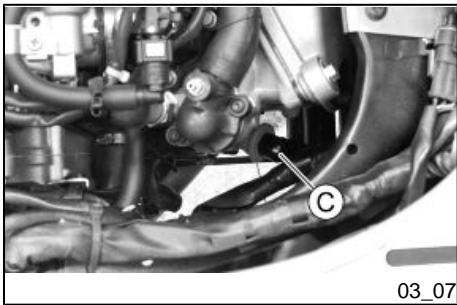

6. Use the box-spanner supplied only for locking.

7. Place the cap fully over the spark plug.

CAUTION



SPARK PLUGS MUST BE REMOVED WHEN THE ENGINE IS COLD. SPARK PLUGS MAINTENANCE OPERATIONS ARE DESCRIBED IN THE SCHEDULED MAINTENANCE TABLE. USING NON-CONFORMING ELECTRONIC CENTRAL UNITS AND ELECTRONIC IGNITIONS OR SPARK PLUGS OTHER THAN THOSE PRESCRIBED MAY SERIOUSLY DAMAGE THE ENGINE.

N.B.

USE OF SPARK PLUGS OTHER THAN THE INDICATED TYPE OR UNSHIELDED SPARK PLUG CAPS CAN LEAD TO FAULTS IN THE VEHICLE 'S ELECTRICAL SYSTEM.

Electric characteristic

Spark plug

NGK CR8EKB

Removing the air filter (03_08, 03_09, 03_10, 03_11)

Proceed as follows:

1. unscrew the fixing screw «A».
2. unscrew the nut «B» under the body.
3. remove the left side fairing.
4. remove the helmet compartment;

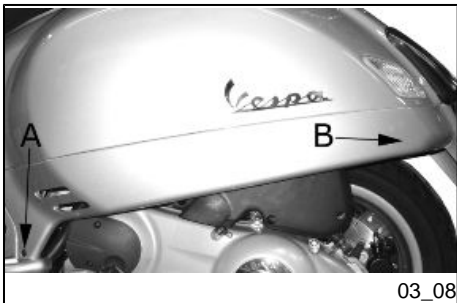



03_09

5. unscrew the fixing screws «C» that can be reached once the helmet compartment has been removed;

6. Unscrew the screws «D» and remove the air filter cover.

Remove the filtering element and clean it with water and shampoo; then dry it with a clean cloth and short blasts of compressed air. Finally, immerse it in a mixture of 50% oil of the recommended type and 50% petrol. Then gently squeeze the filter element between your hands, allow it to drip and then refit it. Oil or water deposits in the filter housing can be cleaned off by removing the two rubber caps «E».

CAUTION



IF THE VEHICLE IS USED ON DUSTY ROADS IT IS NECESSARY TO CARRY OUT MAINTENANCE CHECKS OF THE AIR FILTER MORE OFTEN TO AVOID DAMAGING THE ENGINE.

CAUTION



IN ORDER NOT TO DAMAGE THE VEHICLE PLASTIC COVERS CONTACT AN AUTHORISED SERVICE CENTRE TO HAVE THE AIR FILTER CLEANED.

Recommended products

AGIP FILTER OIL

Oil for air filter sponge

Mineral oil with specific additives for increased adhesiveness

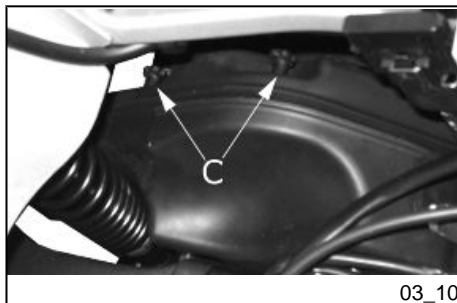

03_10

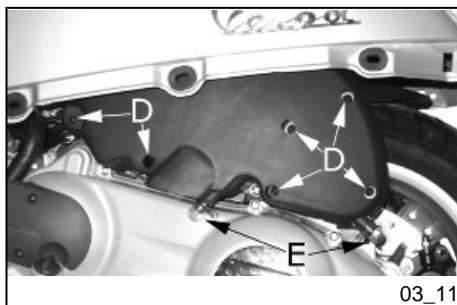

03_11



03_12



03_13

Cooling fluid level (03_12, 03_13)

The engine is cooled by a forced-circulation coolant system. The cooling circuit holds coolant consisting of a mixture of 50% de-ionised water and 50% glycol ethylene-based antifreeze solution with corrosion inhibitors. The recommended coolant is supplied premixed and ready to use. To ensure correct engine operation, the needle on the coolant temperature gauge must be at the centre of the scale. If the needle enters the red zone, turn off the engine, allow the engine to cool then check the coolant level; if the level is OK, take your scooter to an **Authorised Piaggio Service Centre**. If when using your scooter at a low gear the coolant temperature exceeds the above values, shut off the engine and let it cool down. Then check the coolant level; if level is OK, take your scooter to an **Authorised Piaggio Service Centre**. Check coolant when the engine is cold at the intervals indicated in the scheduled maintenance table, following the steps below.

- a) Place the scooter in a vertical position on the stand.
- b) Unscrew the fixing screw «A» and remove the cover.
- c) Check the fluid level according to the two marks- MIN and MAX «B» on the reservoir
- d) Top up if the fluid level is below the MIN level on the scale inside the expansion tank. The fluid level must always be between the MIN and MAX levels.

If the fluid is near the minimum level, top-up only when the engine is cold. If the coolant needs to be topped up frequently or the expansion tank is completely dry, check the cooling system for the cause of the problem. Have the cooling system checked at an **Authorised Piaggio Service Centre**. Coolant must be changed every 2 years at an **Authorised Piaggio Service Centre**.

WARNING



TO AVOID THE RISK OF SCALDING, DO NOT UNSCREW THE EXPANSION TANK COVER WHILE THE ENGINE IS STILL HOT.

WARNING

TO PREVENT AVOID HARMFUL FLUID LEAKAGE WHILE RIDING, ENSURE THAT THE LEVEL NEVER EXCEEDS THE MAXIMUM VALUE.

TO ENSURE CORRECT ENGINE OPERATION, KEEP THE RADIATOR GRILLE CLEAN.

Recommended products**AGIP PERMANENT SPECIAL**

coolant

Monoethylene glycol-based antifreeze fluid, CUNA NC 956-16

Checking the brake oil level (03_14, 03_15)

The brake fluid reservoirs are located on the pumps under the handlebar cover (front on the right-hand side, rear on the left-hand side). The procedures to check the brake fluid level for the front and rear brakes are identical.

Proceed as follows:

1. rest the scooter on its centre stand and make sure the handlebar is centred;
2. check fluid level through the corresponding warning light «C».

A certain lowering of the level is caused by wear on the pads. Should the level appear to be below the minimum mark, please contact an **Authorised Service Centre or Dealer** in order to have a thorough inspection of the braking system carried out. Proceed as follows:

3. remove the tank cover «D» loosening the two screws «E» and refill reaching the correct level with the prescribed brake fluid type only and without exceeding the maximum level.

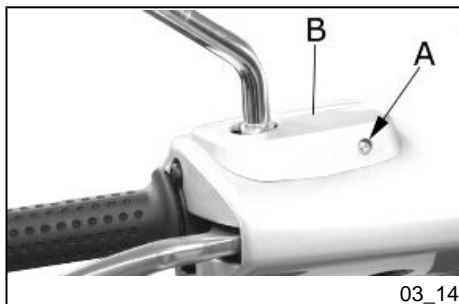

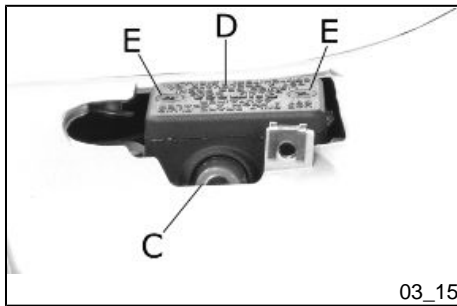

Under normal climatic conditions, the brake fluid should be changed every 2 years. This operation must be carried out by trained personnel; take your vehicle to an **authorised Service centre or Dealer**.

WARNING



ONLY USE DOT 4 CLASS BRAKE FLUIDS. BRAKING CIRCUIT FLUIDS ARE HIGHLY CORROSIVE. MAKE SURE THAT IT DOES NOT COME INTO CONTACT WITH THE PAINTWORK

CAUTION



AVOID CONTACT OF BRAKE FLUID WITH EYES, SKIN, AND CLOTHING. IN CASE OF CONTACT, RINSE WITH WATER. THE BRAKING CIRCUIT FLUID IS HYGROSCOPIC, THAT IS, IT ABSORBS HUMIDITY FROM THE SURROUNDING AIR. IF THE HUMIDITY IN THE BRAKING FLUID EXCEEDS A CERTAIN VALUE, IT WILL LEAD TO INEFFICIENT BRAKING. NEVER USE BRAKING FLUID KEPT IN CONTAINERS THAT HAVE ALREADY BEEN OPENED, OR PARTIALLY USED.

Recommended products

AGIP BRAKE 4

Brake fluid

FMVSS DOT 4 Synthetic fluid

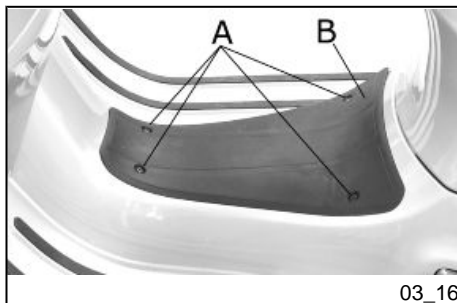

03_16

Battery (03_16, 03_17)

To reach the battery «D», proceed as follows:

1. rest the scooter on its centre stand;
2. unscrew the 4 screws «A», remove the footrest «B».
3. remove the two battery fixing screws «C».

WARNING



IN ORDER TO AVOID DAMAGING THE ELECTRICAL SYSTEM, NEVER DISCONNECT THE WIRING WHILE THE ENGINE IS RUNNING.

CAUTION

UPON CONNECTING THE BATTERY TERMINALS, AVOID CONTACT WITH THE METAL BODY

WARNING

DO NOT TRY TO REMOVE THE BATTERY SEAL. THE ELECTROLYTE IN THE BATTERY CONTAINS SULPHURIC ACID : AVOID CONTACT WITH EYES, SKIN AND CLOTHES. IN THE CASE OF ACCIDENTAL CONTACT, RINSE WITH ABUNDANT OF WATER AND CONSULT A DOCTOR.

WARNING



USED BATTERIES ARE HARMFUL FOR THE ENVIRONMENT. COLLECTION AND DISPOSAL SHOULD BE CARRIED OUT IN COMPLIANCE WITH REGULATIONS IN FORCE.

Electric characteristic

Battery



03_17

12V - 10Ah

Use of a new battery

Ensure that the terminals are connected correctly and check voltage.

CAUTION



DO NOT REVERSE THE POLARITY: RISK OF SHORT CIRCUIT AND DAMAGE TO THE ELECTRICAL SYSTEM.

WARNING



USED BATTERIES ARE HARMFUL FOR THE ENVIRONMENT. COLLECTION AND DISPOSAL SHOULD BE CARRIED OUT IN COMPLIANCE WITH REGULATIONS IN FORCE.

Long periods of inactivity

Battery performance will decrease if the vehicle is not used for a long time. This is the result of the natural phenomenon of battery discharging, and may be due to residual absorption by vehicle components with constant power consumption. Poor battery performance may also be due to environmental conditions and the cleanliness of the poles. In order to avoid difficult starts and/or irreversible damage to the battery, follow any of these steps:

- **At least once a month** start the engine and run it slightly above idle speed for 10-15 minutes. This keeps all the engine components, as well as the battery, in good working order.

- Take your vehicle to a garage (as indicated in the «Vehicle not used for extended periods» section) to have the battery removed. Have the battery cleaned, charged fully and stored in a dry, ventilated place. Recharge **at least once every two months**.

N.B.

THE BATTERY MUST BE CHARGED WITH A CURRENT EQUAL TO 1/10 OF THE RATED CAPACITY OF THE BATTERY AND FOR NOT LONGER THAN 10 HOURS. CONTACT AN AUTHORISED SERVICE CENTRE TO CARRY OUT THIS OPERATION SAFELY. WHEN REFITTING THE BATTERY MAKE SURE THE LEADS ARE CORRECTLY CONNECTED TO THE TERMINALS.

WARNING



DO NOT DISCONNECT THE BATTERY CABLES WITH THE ENGINE RUNNING, THIS CAN CAUSE IRREPARABLE DAMAGE TO THE VEHICLE'S ELECTRONIC CONTROL UNIT.

WARNING



USED BATTERIES ARE HARMFUL FOR THE ENVIRONMENT. COLLECTION AND DISPOSAL SHOULD BE CARRIED OUT IN COMPLIANCE WITH REGULATIONS IN FORCE.

Fuses (03_18, 03_19, 03_20, 03_21, 03_22, 03_23)

The electrical system is equipped with:

1. six protection fuses «**A**» located in the glove compartment to the left
2. two fuses «**B**» located under the helmet compartment under the saddle hinge latch.

3. one fuse «C» located under the helmet compartment on the left fairing.

The chart shows the position and specifications of the fuses in the vehicle.

CAUTION



BEFORE REPLACING A BLOWN FUSE, FIND AND SOLVE THE FAILURE THAT CAUSED IT TO BLOW. NEVER TRY TO REPLACE THE FUSE WITH ANY OTHER MATERIAL (E.G., A PIECE OF ELECTRIC WIRE).

CAUTION



MODIFICATIONS OR REPAIRS TO THE ELECTRICAL SYSTEM, PERFORMED INCORRECTLY OR WITHOUT STRICT ATTENTION TO THE TECHNICAL SPECIFICATIONS OF THE SYSTEM CAN CAUSE MALFUNCTIONING AND RISK OF FIRE.

FUSES

Fuse No. 1

Capacity: 30 A

Protected circuits: Battery recharge circuit, fuses No. 6-7.

Live: Fuses No. 4 - 5 - 8 - 9

Fuse No. 2

Capacity: 7.5 A

Protected circuits: Electric fan solenoid, injection load remote control, immobilizer aerial, ECU.

Fuse No. 3	Capacity: 15A Protected circuits: Injection load (via solenoid), ECU.
Fuse No. 4	Capacity: 10 A Protected circuits: Turn indicators, pre-installation for anti-theft device, instrument panel.
Fuse No. 5	Capacity: 7.5 A Protected circuits: Horn, headlight solenoid.
Fuse No. 6	Capacity: 15A Protected circuits: Electric fan (via solenoid), high-beam and low-beam lights (via solenoid). Live: Saddle opening actuator.
Fuse No. 7	Capacity: 10 A Protected circuits: Pre-installation for antitheft device, instrument panel.
Fuse No. 8	Capacity: 7.5 A Protected circuits: Start-up circuit, stop light.
Fuse No. 9	Capacity: 7.5 A Protected circuits: Tail lights, instrument panel lighting.

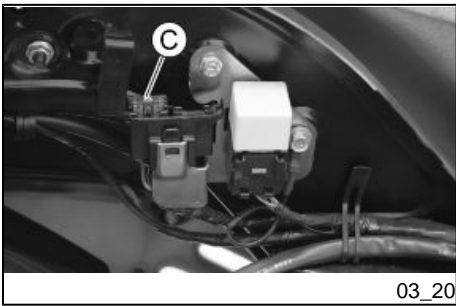
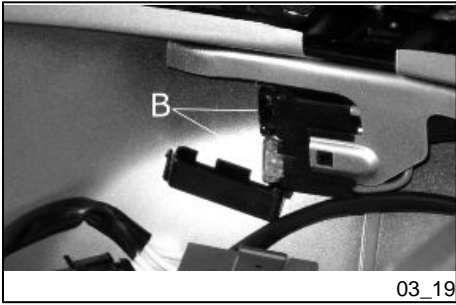
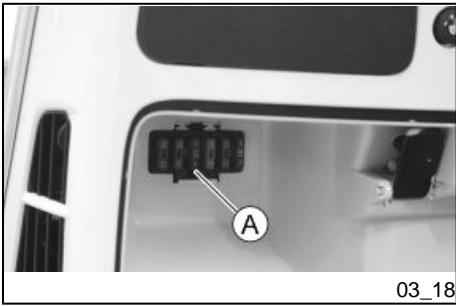

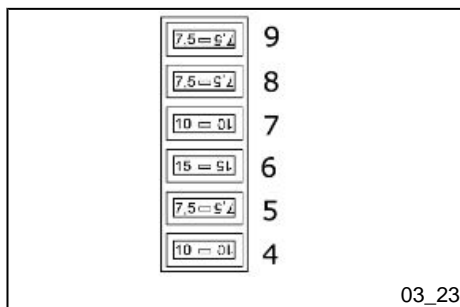
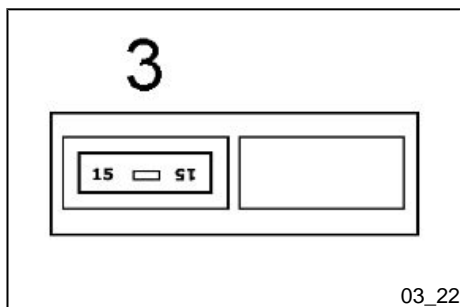
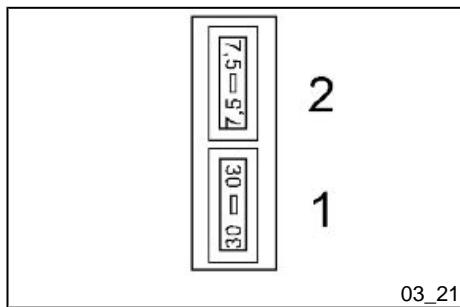

Front light group (03_24, 03_25, 03_26, 03_27)

To remove the front headlight assembly, proceed as follows:

1. Remove the rear-view mirrors.
2. Remove the screw «A» of the legshield grille.
3. Remove the screw «B» fixing the front handlebar cover.
4. Remove the screws «C» fixing the rear handlebar cover.
5. Detach the front handlebar cover.

So there is access to the bulbs. Open the ring nut and take out the high-/low-beam light bulb «D». To change the tail light take out the rubber bulb socket from its fitting. To reassemble, repeat the operation in the reverse order.

WARNING



THE TWIN-FILAMENT (HIGH-BEAM AND LOW-BEAM) BULB IS HALOGEN: DO NOT TOUCH THE BULB WITH YOUR FINGERS TO AVOID COMPROMISING ITS FUNCTIONING

N.B.

IF MISTING IS NOTICED ON THE INSIDE OF THE HEADLAMP GLASS, THIS DOES NOT INDICATE A FAULT AND IS ATTRIBUTABLE TO HUMIDITY AND/OR TO LOW TEMPERATURES.

THE PHENOMENON SHOULD QUICKLY DISAPPEAR WHEN THE LIGHT IS SWITCHED ON.

THE PRESENCE OF DROPS OF WATER, ON THE OTHER HAND, COULD INDICATE THAT WATER IS INFILTRATING. CONTACT THE AFTER-SALES SERVICE NETWORK.

CAUTION



DO NOT CARRY ANY GARMENTS ON THE FRONT HEADLIGHT ASSEMBLY. THIS MAY CAUSE BULBS TO OVERHEAT AND THEREFORE ABNORMAL WEAR.

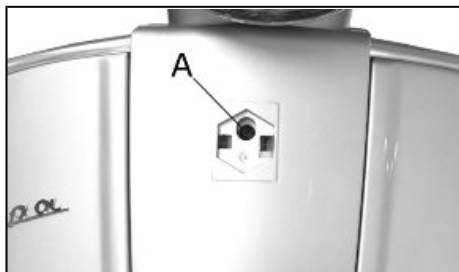

03_24

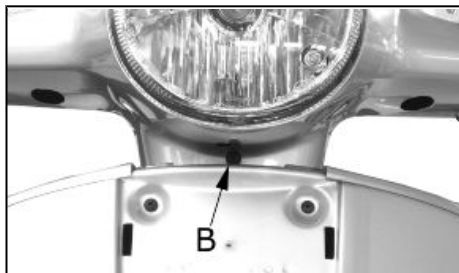

03_25



03_26

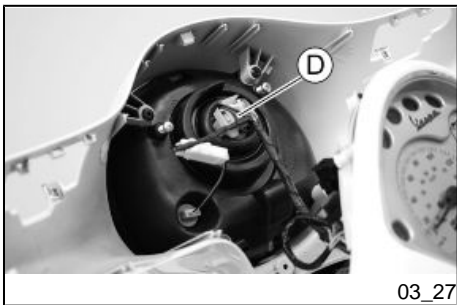

03_27

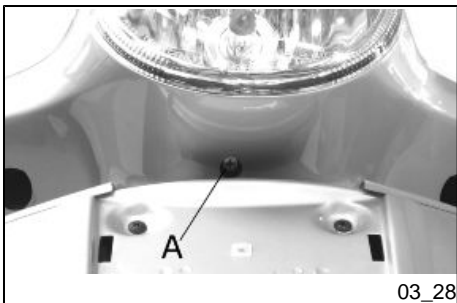

03_28

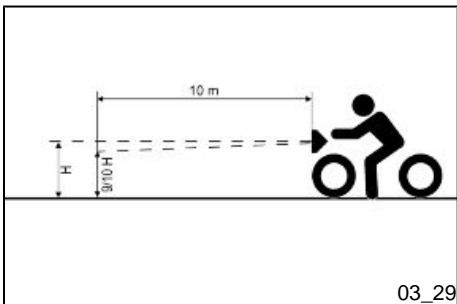

03_29

Headlight adjustment (03_28, 03_29)

Proceed as follows:

1. Place the vehicle in running order and with the tyres inflated to the prescribed pressure, on a flat surface 10 m away from a white screen situated in a shaded area, making sure that the longitudinal axis of the vehicle is perpendicular to the screen;
2. Turn on the headlight and check that the borderline of the projected light beam on the screen is no higher than 9/10 or lower than 7/10 of the distance from the ground to the centre of the vehicle's headlamp;
3. If otherwise, adjust the right headlight with screw «A».

N.B.

THE ABOVE PROCEDURE COMPLIES WITH THE EUROPEAN STANDARDS REGARDING MAXIMUM AND MINIMUM HEIGHT OF LIGHT BEAMS. REFER TO THE STATUTORY REGULATIONS IN FORCE IN EVERY COUNTRY WHERE THE VEHICLE IS USED.



03_30

Front direction indicators (03_30)

To replace the front turn indicator bulbs, remove the tail light taking out the retaining screw "A", remove the bulb holder from its fitting; gently turn the bulb around 30° and remove it. Follow the process in reverse order to refit.



03_31

Rear optical unit (03_31)

Remove screw «A» to remove the rear headlight assembly.

Access to taillight bulbs, stop light bulb and license plate bulb.

To reassemble, repeat the operation but in reverse order.

N.B.

IF MISTING IS NOTICED ON THE INSIDE OF THE HEADLAMP GLASS, THIS DOES NOT INDICATE A FAULT AND IS ATTRIBUTABLE TO HUMIDITY AND/OR TO LOW TEMPERATURES.

THE PHENOMENON SHOULD QUICKLY DISAPPEAR WHEN THE LIGHT IS SWITCHED ON.

THE PRESENCE OF DROPS OF WATER, ON THE OTHER HAND, COULD INDICATE THAT WATER IS INFILTRATING. CONTACT THE AFTER-SALES SERVICE NETWORK.

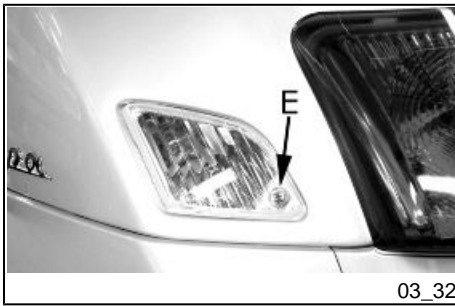

03_32

Rear turn indicators (03_32)

To gain access to the turn indicator bulbs, remove the fastening screws «E».

The bulbs have a bayonet coupling, to remove them press gently and twist anticlockwise about 30°. To refit follow the same steps but in reverse order.

Rear-view mirrors

Adjust the mirrors by applying slight pressure to the side of the mirror to move it to the desired position.

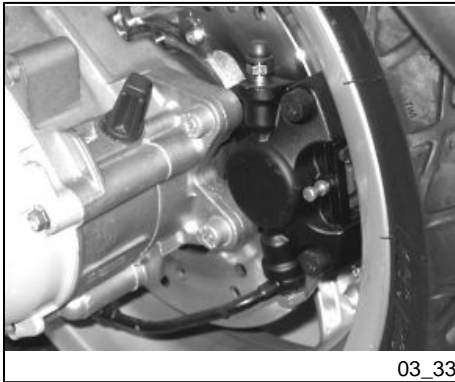

03_33

Front and rear disc brake (03_33, 03_34)

The brake disc and pad wear is automatically compensated, therefore it has no effect on the functioning of the front and rear brakes. For this reason it is not necessary to adjust the brakes. An excessively elastic brake lever stroke may indicate the presence of air in the braking circuit or a failure in the braking system. In this case, mainly due to the importance of brakes to guarantee safe riding conditions, the vehicle should be taken to an **Authorised Service Centre or Dealer**.

CAUTION



BRAKING SHOULD BEGIN AFTER ABOUT 1/3 OF THE BRAKE LEVER STROKE.

**CAUTION**

HAVE THE BRAKE PADS CHECKED BY THE DEALER ACCORDING TO THE CHECKS SPECIFIED IN THE SCHEDULED MAINTENANCE TABLE. HOWEVER, IN THE EVENT OF NOISES COMING FROM THE FRONT AND/OR REAR BRAKING SYSTEM DURING OPERATION, IT IS ADVISABLE TO HAVE THE BRAKING SYSTEM CHECKED BY AN AUTHORISED SERVICE CENTRE OR DEALER. AFTER REPLACING THE BRAKE PADS, DO NOT USE THE SCOOTER UNTIL YOU HAVE OPERATED THE BRAKE LEVER SEVERAL TIMES IN ORDER TO ALLOW THE PLUNGERS TO SETTLE AND THE LEVER STROKE TO BE SET TO THE CORRECT POSITION.

CAUTION

THE PRESENCE OF SAND, MUD, SNOW MIXED WITH SALT, ETC. ON THE ROAD, CAN DRASTICALLY REDUCE THE LIFE OF THE BRAKE PADS. IN ORDER TO AVOID THIS, WE RECOMMEND WASHING THE VEHICLE FREQUENTLY WHEN RIDING IN THESE ROAD CONDITIONS.

Puncture

The vehicle is equipped with Tubeless tyres (without inner tube). In the event of a puncture, Tubeless tyres - unlike tyres with inner tubes - go flat very slowly, resulting in a greater steering safety. In the event of a puncture, an emergency repair can be carried out using an "inflate and repair" spray can. For a final repair, take your vehicle to an **Authorised Service Centre or Dealer**. The replacement of a tyre involves removing the wheel in question. Take your vehicle to an **Authorised Service Centre or Dealer** for these operations.

CAUTION

TO USE THE "INFLATE AND REPAIR" SPRAY CAN PROPERLY, FOLLOW THE INSTRUCTIONS ON THE PACKAGING.

WARNING

THE WHEELS FITTED WITH TYRES SHOULD ALWAYS BE BALANCED. RIDING THE VEHICLE WITH VERY LOW TYRE PRESSURE OR WITH INCORRECTLY BALANCED TYRES CAN LEAD TO DANGEROUS STEERING VIBRATIONS.



03_35

Periods of inactivity (03_35)

We recommend carrying out the following operations:

1. Clean the vehicle thoroughly and then cover it with a canvas;
2. With the engine off and the piston in the bottom dead centre position, remove the spark plug, and pour into its hole 1 to 2 cc of the recommended oil. Operate the starter button 1-2 times for roughly 1 second to turn the engine over slowly, then insert the spark plug again;
3. Ensure that the **fuel tank is at least half full (in order to ensure the total immersion of the fuel pump)**; spread antirust grease on the uncoated metal parts; keep the wheels lifted above the ground by resting the chassis on two wooden wedges;
4. As regards the battery, follow the instructions in the «Battery» section.

Recommended products**AGIP CITY HI TEC 4T**

Oil to lubricate flexible transmissions (throttle control)

Oil for 4-stroke engines

Cleaning the vehicle

Use a low pressure water jet in order to soften the dirt and mud deposited on painted surfaces. Once softened, mud and dirt must be removed with a soft sponge for body-work soaked with water and shampoo (2-4% of shampoo in water). Then rinse abundantly with water, and dry with a shammy cloth. Any polishing with silicon wax must always be preceded by washing

WARNING



IF THE SCOOTER IS USED ON DUSTY ROADS IT IS NECESSARY TO SERVICE THE TRANSMISSION COVER FILTER SPONGE MORE FREQUENTLY.

CAUTION



DETERGENTS CAN POLLUTE WATER. THE VEHICLE MUST BE WASHED AT A WASH STATION EQUIPPED WITH A SPECIAL WATER PURIFICATION SYSTEM.

WARNING



THE USE OF A HIGH-PRESSURE WATER JET IS STRONGLY DISCOURAGED FOR ANY ENGINE CLEANING OPERATION; HOWEVER, IF NO OTHER MEANS ARE AVAILABLE, IT IS THEN NECESSARY TO:

- **ONLY USE FAN SPRAY JETS.**
- **KEEP NOZZLE AT LEAST 60 CM AWAY FROM THE VEHICLE.**
- **DO NOT USE WATER AT TEMPERATURES ABOVE 40°C.**

- DO NOT USE HIGH-PRESSURE WATER JETS.
- DO NOT STEAM WASH.
- DO NOT DIRECT THE JET STRAIGHT TO THE WIRING AND COOLING SLIT ON THE TRANSMISSION COVER.

WARNING

NEVER WASH THE SCOOTER IN DIRECT SUNLIGHT, ESPECIALLY DURING SUMMER WHEN THE BODYWORK IS STILL HOT, AS THE SHAMPOO CAN DAMAGE THE PAINTWORK IF IT DRIES BEFORE BEING RINSED OFF. NEVER USE CLOTHS SOAKED IN PETROL, DIESEL OIL OR KEROSENE FOR CLEANING THE PAINTED OR PLASTIC SURFACES SO AS NOT TO DAMAGE THE LUSTRE FINISH OR ALTER THE MECHANICAL PROPERTIES.

WARNING

To avoid the appearance of oxidations, wash the vehicle every time it is used in certain areas or in special conditions of:

- **Environmental / seasonal conditions:** use of salt, de-icer chemical products on the road in winter.
- **Air pollution:** city and/or industrial areas.
- **Salinity and humidity of the atmosphere:** marine areas, hot and wet weather.

WARNING

- Avoid that deposits remain on the bodywork, industrial and pollutant residual dust, tar spots, dead insects, bird droppings, etc.
- Do not park the vehicle under the trees. In some seasons, as from the trees may fall residues, resins, fruits or leaves that contain chemicals which are harmful to the paintwork.

STARTING FAILURE

Emergency switch in «OFF»	Set the switch back to « ON »
Fuse blown	Replace the blown fuse and have the vehicle checked by an Authorised Service Centre.

IGNITION PROBLEMS

Faulty spark plug	Contact an Authorised Service Centre.
Faulty ignition / injection control unit.	Contact an Authorised Service Centre.
Faulty coil. Due to the presence of high voltage, this check should only be carried out by an expert.	Contact an Authorised Service Centre.

LACK OF COMPRESSION

Loose spark plug.	Screw in the spark plug tightly
Cylinder head loose, piston gas rings worn.	Contact an Authorised Service Centre.
Valve stuck	Contact an Authorised Service Centre.

HIGH CONSUMPTION AND LOW PERFORMANCE

Air filter blocked or dirty.	Clean with water and shampoo and impregnate with petrol and specific oil («Air filter removal» section)
------------------------------	---

INSUFFICIENT BRAKING

Greasy disc. Worn pads. Faulty braking system. Presence of air in the front and rear brake circuit.	Contact an Authorised Service Centre.
---	--

INEFFICIENT SUSPENSION

Shock absorber fault, oil leak, end buffers damaged; shock absorber preloading incorrectly set	Contact an Authorised Service Centre .
--	---

AUTOMATIC TRANSMISSION PROBLEMS

CVT rollers and/or drive belt damaged	Contact an Authorised Service Centre .
---------------------------------------	---

Vespa GTS 300 I.E.

Vespa®



Chap. 04
Technical data

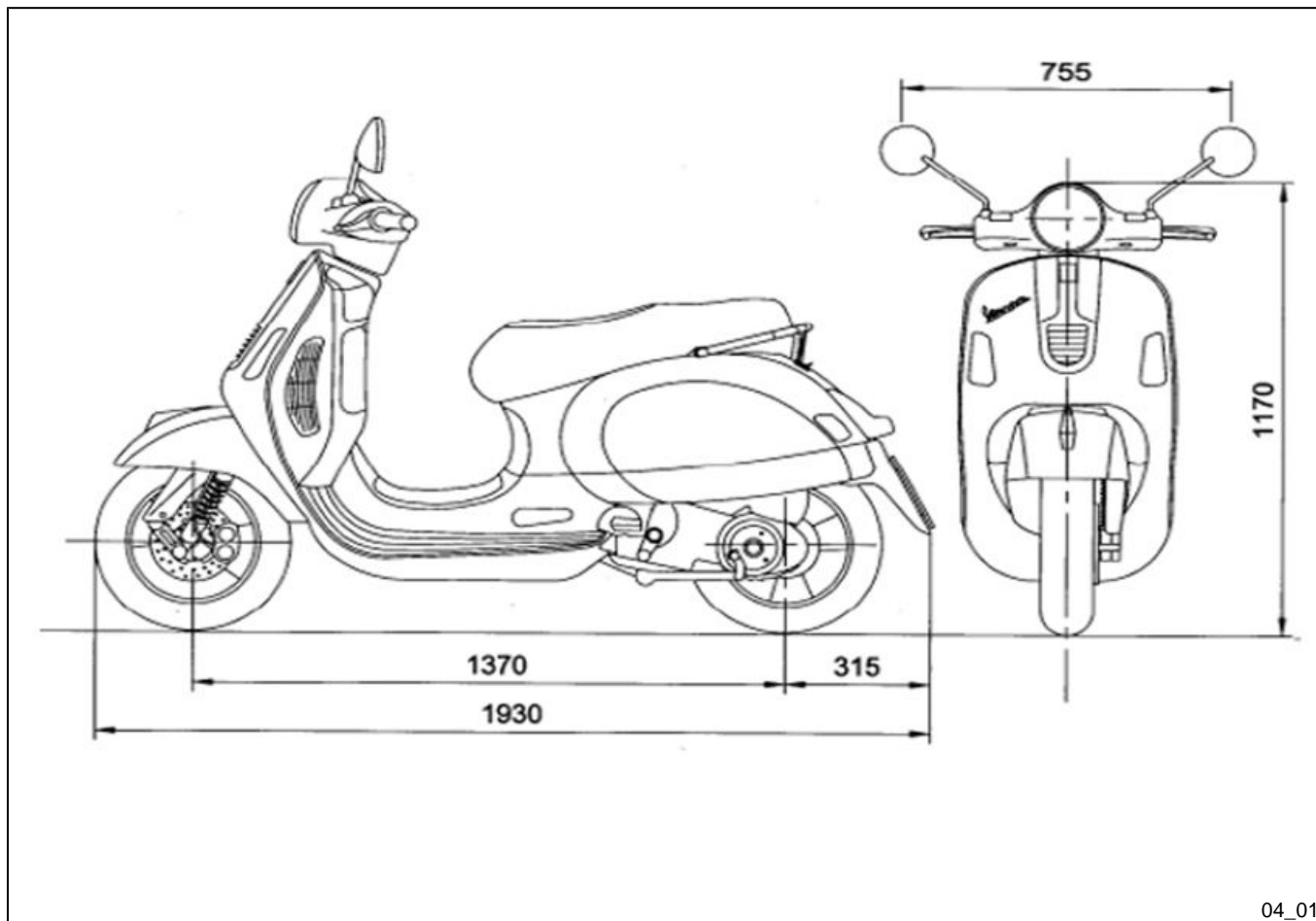

ENGINE TECHNICAL DATA

Type	Single-cylinder, 4-stroke
Engine capacity	278 cm ³
Bore x Stroke	75x63 mm
Compression ratio	11 ± 0.5 : 1
Engine idle speed	1,700 ± 100 rpm
Timing system	4 valves, single overhead camshaft, chain-driven.
Valve clearance	Intake: 0.10 mm Exhaust: 0.15 mm
Max. power	16.2 kW at 7,500 rpm
MAX. torque	22.3 at 5,000 rpm
Transmission	CVT expandable pulley variator with torque server, V-belt, self-ventilating dry automatic centrifugal clutch and transmission housing with forced-circulation air cooling.
Final reduction gear	Gear reduction unit in oil bath.
Lubrication	Engine lubrication with lobe pump (inside crankcase), chain-driven, with double filter: mesh and paper.
Cooling	Forced coolant circulation system.
Electric	starter

Ignition	Electronic inductive discharge ignition, high efficiency, with separate HV coil.
Ignition advance	α/N three-dimensional map managed by control unit
Spark plug	NGK CR8EKB
Alternative spark plug	-
Fuel system	Electronic injection with \varnothing 32-mm throttle body and electric fuel pump.
Fuel	Unleaded petrol (95 RON)
Exhaust silencer	Absorption-type exhaust silencer with a 3-way catalytic converter and lambda probe.
Emissions compliance	EURO 3

VEHICLE TECHNICAL DATA

Chassis	Stamped plate supporting body.
Front suspension	Single arm suspension (cantilever wheel) fitted with a dual-chamber hydraulic shock absorber with coaxial spring.
Rear suspension	Two double-acting shock absorbers, adjustable to four positions at preloading.
Front brake	\varnothing 220 mm disc with calliper with counteracting pistons.

Rear brake	disc brake, diameter 220 mm, with hydraulic servo operated from the handlebar with the left-hand lever.
Wheel rim type	Light alloy wheel rims.
Front wheel rim	12" x 3.00
Rear wheel rim	12" x 3.00
Front tyre	120/70 - 12" 51P Tubeless
Rear tyre	Tubeless 130/70 12" 62P
Front tyre pressure (with passenger)	1.8 bar (-)
Rear tyre pressure (with passenger)	2.2 bar (-)
Kerb weight	151 ± 5 kg
Maximum weight allowed	340 kg
Battery	12V-10Ah

CAPACITY

Engine oil	1.3 l
Transmission oil	250 cm ³
Cooling system fluid	~ 2 l
Fuel tank capacity	~ 9.2 litres

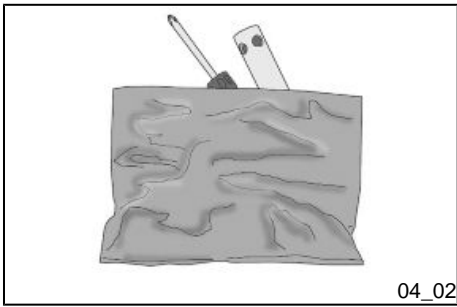

Toolkit (04_02)

One box-spanner for spark plugs; one twin screwdriver; one special spanner for adjusting the rear shock absorber. The tools are arranged in the front case.

Vespa GTS 300 I.E.

Vespa®



**Chap. 05
Spare parts and
accessories**

Warnings

WARNING



TO PREVENT ACCIDENTS AND TO GUARANTEE PROPER STABILITY, PERFORMANCE AND SAFETY, RIDE THE VEHICLE VERY CAREFULLY WHEN IT IS FITTED WITH ACCESSORIES OR WITH UNUSUAL LOADS.

WARNING



IT IS ALSO RECOMMENDED THAT ORIGINAL PIAGGIO SPARE PARTS BE USED, AS THESE ARE THE ONLY ONES OFFERING YOU THE SAME QUALITY GUARANTEE AS THOSE INITIALLY FITTED ON THE SCOOTER. THE USE OF NON-ORIGINAL SPARE PARTS RENDERS THE WARRANTY VOID.

WARNING



PIAGGIO MARKETS ITS OWN LINE OF ACCESSORIES THAT ARE RECOGNISED AND GUARANTEED FOR USE. IT IS THEREFORE ESSENTIAL TO CONTACT AN AUTHORISED DEALER OR SERVICE CENTRE IN ORDER TO CHOOSE AND FIT ACCESSORIES CORRECTLY. THE USE OF NON-ORIGINAL ACCESSORIES MAY AFFECT THE STABILITY AND OPERATION OF YOUR VEHICLE AND REDUCE SAFETY LEVELS WITH POTENTIAL RISKS FOR THE RIDER.

WARNING

NEVER RIDE THE SCOOTER EQUIPPED WITH ACCESSORIES (TOP BOX AND/OR WINDSHIELD) AT A SPEED HIGHER THAN 100 km/h.

THE SCOOTER CAN BE RIDDEN AT A HIGHER SPEED WITHOUT THE ACCESSORIES MENTIONED BEFORE WITHIN THE LIMITS ESTABLISHED BY LAW.

IF THERE ARE ANY NON-PIAGGIO ACCESSORIES INSTALLED, OR AN ABNORMAL LOAD, OR IF THE SCOOTER IS NOT IN A GENERALLY GOOD CONDITION, OR WHENEVER WEATHER CONDITIONS DEMAND IT, SPEED SHOULD BE FURTHER REDUCED.

WARNING

BE EXTREMELY CAREFUL WHEN INSTALLING AND REMOVING THE MECHANICAL ANTITHEFT DEVICE ON THE VEHICLE (U-SHAPED PADLOCK, DISC BLOCK, ETC.).

MAINLY NEAR THE BRAKE PIPES, TRANSMISSIONS AND/OR ELECTRIC CABLES, AN INCORRECT INSTALLATION OR REMOVAL OF THE ANTITHEFT DEVICE AS WELL AS LEAVING IT ON BEFORE STARTING THE VEHICLE CAN SERIOUSLY DAMAGE ITS COMPONENTS, COMPROMISE THE CORRECT FUNCTIONING OF THE VEHICLE AND USERS' SAFETY.

Vespa GTS 300 I.E.

Vespa®



**Chap. 06
Scheduled
maintenance**



06_01

Scheduled servicing table (06_01)

Adequate maintenance is fundamental to ensuring long-lasting, optimum operation and performance of your vehicle.

To this end, a series of checks and maintenance operations (at the owner's expense) have been suggested, which are included in the summary table on the following page. Any minor faults should be reported without delay to an **Authorised Service Centre or Dealer** without waiting until the next scheduled service to solve it.

It is indispensable to have your vehicle serviced to the prescribed intervals of time, even if you have not reached the predicted mileage. Punctual vehicle servicing is necessary for the correct use of the guarantee. For all further information regarding the Guarantee application modes and the execution of the "Programmed Maintenance" refer to the "Guarantee Booklet".

SCHEDULED MAINTENANCE TABLE

Km x 1,000	1	5	10	15	20	25	30	35	40	45	50	55	60
Safety fasteners	I		I				I				I		I
Spark plug			R		R		R		R		R		R
Drive belt				R			R			R			R
Throttle control	A		A		A		A		A		A		A
Air filter			C		C		C		C		C		C
Belt compartment air filter			I		I		I		I		I		I
Oil filter	R		R		R		R		R		R		R
Valve clearance					A				A				A
Electrical system and battery	I		I		I		I		I		I		I
Brake fluid *	I		I		I		I		I		I		I

Km x 1,000	1	5	10	15	20	25	30	35	40	45	50	55	60
Coolant *	I		I		I		I		I		I		I
Engine oil	R	I	R	I	R	I	R	I	R	I	R	I	R
Hub oil	R		I		R		I		R		I		R
Brake pads	I	I	I	I	I	I	I	I	I	I	I	I	I
Sliding shoes / CVT rollers			R		R		R		R		R		R
Tyre pressure and wear	I		I		I		I		I		I		I
Vehicle road test	I		I		I		I		I		I		I
Suspension			I		I		I		I		I		I
Steering	A		A		A		A		A		A		A

I: CHECK AND CLEAN, ADJUST, LUBRICATE OR REPLACE IF NECESSARY.

C: CLEAN, R: REPLACE, A: ADJUST, L: LUBRICATE

** Replace every 2 years*

RECOMMENDED PRODUCTS TABLE

Product	Description	Specifications
AGIP ROTRA 80W-90	Rear hub oil	SAE 80W/90 Oil that exceeds the requirements of API GL3 specifications
AGIP CITY HI TEC 4T	Oil to lubricate flexible transmissions (throttle control)	Oil for 4-stroke engines
AGIP FILTER OIL	Oil for air filter sponge	Mineral oil with specific additives for increased adhesiveness

Product	Description	Specifications
AGIP GP 330	Grease for brake levers, throttle	White calcium complex soap-based spray grease with NLGI 2; ISO-L-XBCIB2
AGIP CITY HI TEC 4T	Engine oil	SAE 5W-40, API SL, ACEA A3, JASO MA Synthetic oil
AGIP BRAKE 4	Brake fluid	FMVSS DOT 4 Synthetic fluid
AGIP PERMANENT SPECIAL	coolant	Monoethylene glycol-based antifreeze fluid, CUNA NC 956-16

TABLE OF CONTENTS

A

Air filter: 44

B

Battery: 49, 50

Brake: 47, 60

C

Checks: 26

Clock: 11

D

Disc brake: 60

E

Engine oil: 38, 39

Engine stop: 15

F

Fuel: 19

Fuses: 51

H

Headlight: 58

Horn: 13

Hub oil: 40

I

Identification: 21

Immobilizer: 15, 16, 18

Instrument panel: 10

K

Key switch: 12

Keys: 15

L

Light switch: 14

M

Maintenance: 37, 79

Mirrors: 60

P

Puncture: 61

R

Refuelling: 26

S

Saddle: 20

Scheduled maintenance: 79

Shock absorbers: 29

Spark plug: 43

Stand: 33

Start-up: 14

Switch: 12–14

T

Tank: 19

Technical Data: 69

Toolkit: 74

Top box: 22

Transmission: 33

Turn indicators: 60

Tyre pressure: 28

Tyres: 42

V

Vehicle: 7, 63



The descriptions and illustrations given in this publication are not binding. While the basic specifications as described and illustrated in this manual remain unchanged, PIAGGIO-GILERA reserves the right, at any time and without being required to update this publication beforehand, to make any changes to components, parts or accessories, which it considers necessary to improve the product or which are required for manufacturing or construction reasons.

Not all versions/models shown in this publication are available in all countries. The availability of each model should be checked at the official Piaggio sales network.

"© Copyright 2008 - PIAGGIO & C. S.p.A. Pontedera. All rights reserved. Reproduction of this publication in whole or in part is prohibited."

PIAGGIO & C. S.p.A. - Aftersales

V.le Rinaldo Piaggio, 23 - 56025 PONTEDERA (Pi)