

Vespa would like to thank you

for choosing one of its products. We have prepared this manual to help you to get the very best from your scooter. Please read it carefully before riding the scooter for the first time. It contains information, tips and precautions for using your scooter. It also describes features, details and devices to assure you that you have made the right choice. We believe that if you follow our suggestions, you will soon get to know your new vehicle and it will serve you well for a long time to come. This booklet forms an integral part of the scooter; should the scooter be sold, it must be transferred to the new owner.

Vespa LX 125 150 4T



The instructions given in this manual are intended to provide a clear, simple guide to using your scooter; this booklet also details routine maintenance procedures and regular checks that should be carried out on the vehicle at an **authorised Dealer or Service Centre**. The booklet also contains instructions for simple repairs. Any operations not specifically described in this manual require the use of special tools and/or particular technical knowledge: to carry out these operations refer to any **authorised Dealer of Service Centres**.



Personal safety

Failure to completely observe these instructions will result in serious risk of personal injury.



Safeguarding the environment

Sections marked with this symbol indicate the correct use of the vehicle to prevent damaging the environment.



Vehicle intactness

The incomplete or non-observance of these regulations leads to the risk of serious damage to the vehicle and sometimes even the invalidity of the guarantee.

The signs that you see on this page are very important. They are used to highlight those parts of the booklet that should be read with particular care. As you can see, each sign consists of a different graphic symbol, making it quick and easy to locate the various topics.

INDEX

VEHICLE	7	Engine oil level check.....	30
Dashboard.....	8	Engine oil top-up.....	31
Clock.....	9	Warning light (insufficient oil pressure).....	31
Key switch.....	10	Engine oil change.....	31
Locking the steering wheel.....	10	Hub oil level.....	32
Releasing the steering wheel.....	10	Tyres.....	34
Switch direction indicators.....	11	Spark plug dismantlement.....	35
Horn button.....	11	Removing the air filter.....	36
Light switch.....	12	Secondary air system.....	37
Start-up button.....	12	Checking the brake oil level.....	38
The immobilizer system.....	12	Battery.....	39
Keys.....	12	Checking the electrolyte level.....	40
Immobilizer device enabled indicator led.....	13	Long periods of inactivity.....	40
Operation.....	13	Fuses.....	41
Programming the immobilizer system.....	14	Front light group.....	44
Opening the saddle.....	15	Headlight adjustment.....	44
Identification.....	16	Front direction indicators.....	45
Rear top box opening.....	16	Rear optical unit.....	45
Bag clip.....	17	Rear turn indicators.....	46
USE	19	Number plate light.....	46
Checks.....	20	Rear-view mirrors.....	47
Refuelling.....	20	Idle adjustment.....	47
Tyre pressure.....	21	Front disc brake.....	48
Shock absorbers adjustment.....	22	Rear drum brake.....	49
Running in.....	23	Puncture.....	49
Starting up the engine.....	23	Periods of inactivity.....	50
Precautions.....	24	Cleaning the vehicle.....	50
Difficult start up.....	25	TECHNICAL DATA	55
Stopping the engine.....	26	Kit equipment.....	60
Automatic transmission.....	26	SPARE PARTS AND ACCESSORIES	61
Safe driving.....	27	Warnings.....	62
MAINTENANCE	29	PROGRAMMED MAINTENANCE	63
Engine oil level.....	30	Scheduled maintenance table.....	64

Vespa LX 125 150 4T

Vespa®



**Chap. 01
Vehicle**

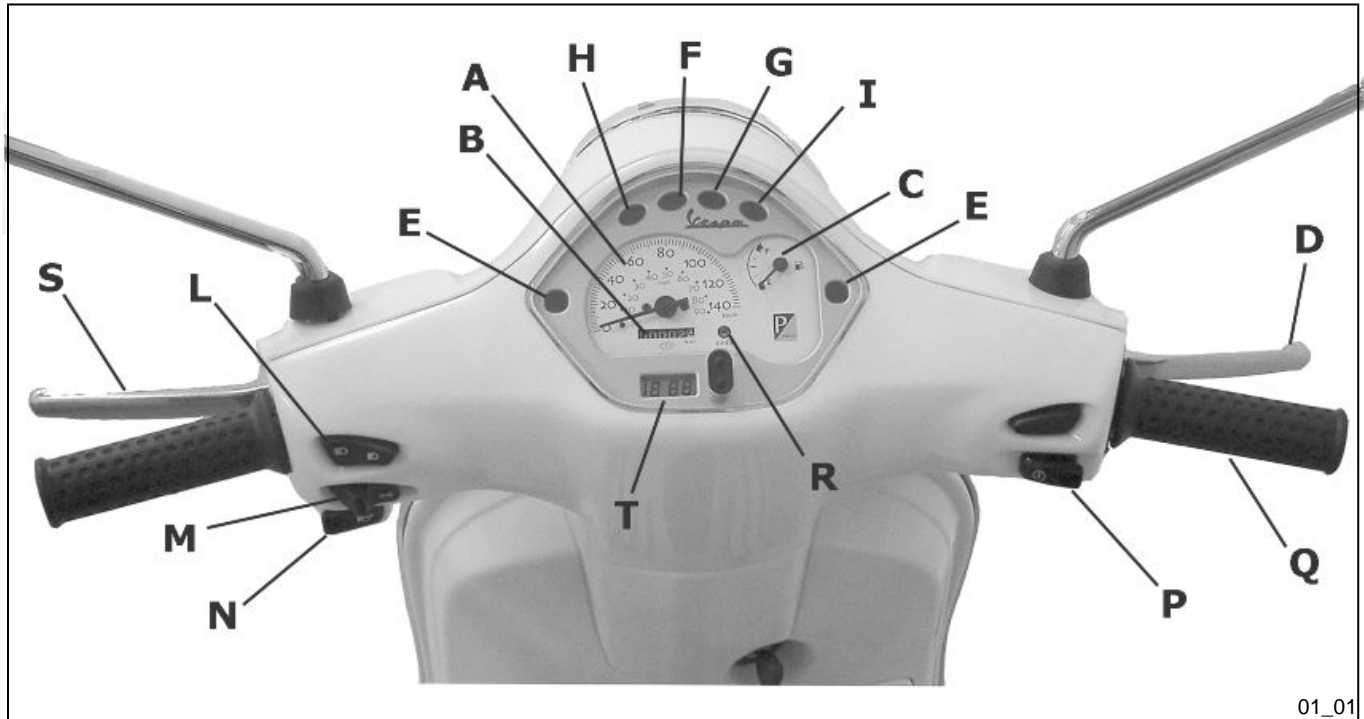

01_01

Dashboard (01_01)

A = Speedometer

B = Odometer

C = Fuel gauge

- D = Front brake lever
- E = Turn signal warning light
- F = Low oil pressure warning light
- G = High-beam warning light
- H = Low fuel warning light
- I = Low-beam warning light
- L = Low/High-beam switch
- M = Turn signal switch
- N = Horn button
- P = Starter button
- Q = Throttle
- R = Immobiliser LED (if available)
- S = Rear brake lever
- T = Digital clock

Clock (01_02)

Hours and minutes are displayed in a 1 to 12, AM or PM, format on the instrument panel.

Operating the function selection switch «T» month, day and seconds can be seen besides hours and minutes. In order to adjust the above mentioned functions, operate button «U». The digital clock is powered by a battery (battery life is about 2 years); lift the whole instrument panel to replace the battery. It is advisable to take your vehicle to an **Authorised Service Centre** for this operation.





WARNING



DEAD BATTERIES ARE HARMFUL TO THE ENVIRONMENT. THEY MUST BE DISPOSED OF IN SUITABLE CONTAINERS AS PRESCRIBED BY THE REGULATIONS IN FORCE.

Key switch (01_03)

LOCK = Ignition disabled, extractable key, steering lock engaged front glove-box locked.

OFF = Ignition disabled, extractable key, steering lock disengaged, front glove-box unlocked.

ON = Starter position, anti-theft device disabled, non-extractable key, glove-box unlocked.

Locking the steering wheel

Turn the handlebar to the left (as far as it will go), turn the key to position «**LOCK**» and remove the key.

CAUTION



DO NOT TURN THE KEY TO «LOCK» OR «OFF» WHILE RIDING.

Releasing the steering wheel

Reinsert the key and turn it to «**OFF**».

CAUTION

DO NOT TURN THE KEY TO «LOCK» OR «OFF» WHILE RIDING.

Switch direction indicators (01_04)

To set the left turn indicators flashing, move lever «**B**» to the left; to set the right turn indicators flashing, move it to the right. The lever automatically returns to the central position and the indicators remain on. To turn the indicators off, press the lever towards the switch.

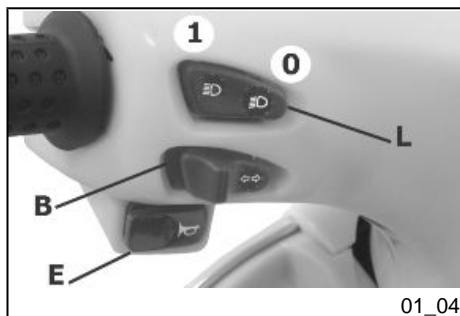
**Horn button (01_05)**

Horn button «**E**»

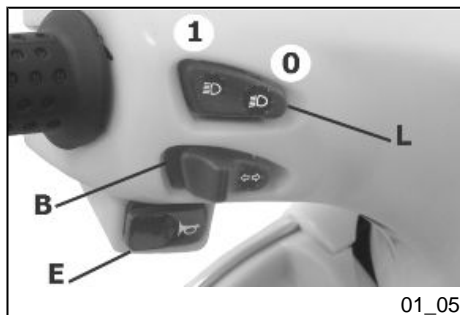

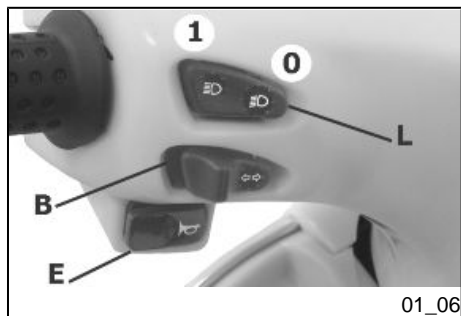

Light switch (01_06)

0 = Dipped beam and position light

1 = High beam and position light

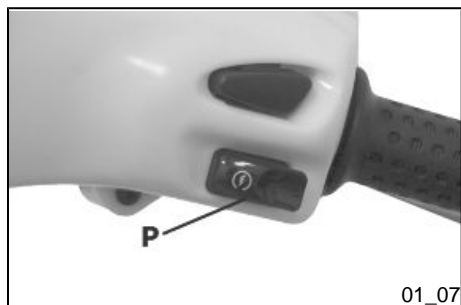

Start-up button (01_07)

To start the engine, press the starter button, «P», after pulling either one of the two brake levers.

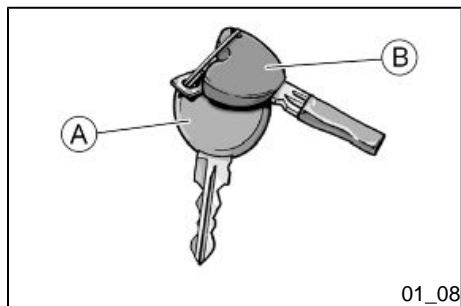

The immobilizer system

In order to enhance theft protection, the scooter is equipped with a «**PIAGGIO IMMOBILIZER**» electronic engine locking device that is activated automatically when the starter key is removed. Upon start-up, the «**PIAGGIO IMMOBILIZER**» system checks the starter key, and only if this key is recognised will the immobilizer system allow the scooter to be started.

Keys (01_08, 01_09, 01_10)

Two types of keys come with the vehicle. Key «A» with the brown grip is the «**MAS-TER**» key. Only a single copy of this key is supplied, which is necessary to program all your other keys and for your dealer to perform some maintenance operations. We



01_09

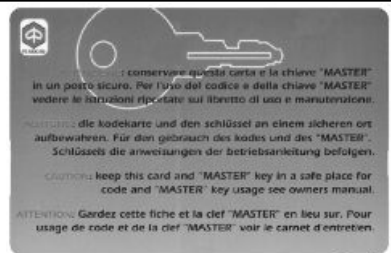

01_10

therefore recommend that it be used only under exceptional circumstances. Black key «B» (single copy supplied) is used for normal use such as:

- start-up
- saddle opening
- glove box opening

Together with the keys, you will receive a **CODE CARD** bearing the same code imprinted onto the two keys.

WARNING



THE LOSS OF THE BROWN KEY PREVENTS LATER REPAIRS TO THE "PIAGGIO IMMOBILIZER" SYSTEM AND TO THE ENGINE CONTROL UNIT.

Immobilizer device enabled indicator led (01_11)

The activation of the «PIAGGIO IMMOBILIZER» system is shown by the flashing of the appropriate warning light «A» (see «Instrument panel» section).

In order to reduce battery discharge, the indicator LED turns off automatically after 48 hours of uninterrupted functioning.

Should the system fail, different LED flashing patterns will be provided by an **Authorised Piaggio-Gilera Service Centre** with information on the type of fault detected.

Operation

Every time the starter key is removed in the "OFF" or "LOCK" position, the safety system activates the immobilizer system. Turning the key to "ON" disables the engine lock, provided that the safety system recognises the code transmitted by the key. If the code is not recognised, turn the key first to "OFF" and then to "ON"; if the lock cannot be disabled, try with the other key supplied (brown). If the engine cannot be started, contact an **Authorised Piaggio Service Centre**, which is provided with the electronic equipment required to detect and repair the system.

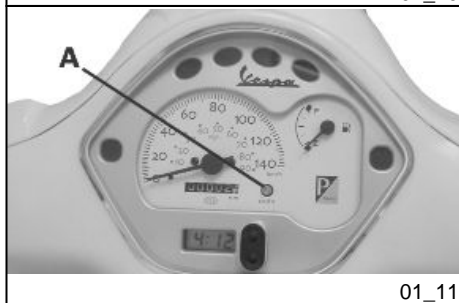

01_11

When supplementary keys are required, remember that the programming (up to a maximum of three keys) must be performed on all the keys whether they are new or already in your possession.

Take the key with the brown grip and all the black keys supplied to an **Authorised Piaggio Service Centre**.

The codes of keys not submitted for the new storage procedure are deleted from the memory. Any lost keys will therefore not be enabled to start the engine.

WARNING



EACH KEY HAS ITS OWN AND UNIQUE CODE, WHICH MUST BE STORED BY THE SYSTEM CONTROL UNIT.

VIOLENT SHOCKS MAY AFFECT THE ELECTRONIC COMPONENTS OF THE KEY.

SHOULD THE VEHICLE CHANGE OWNERS, IT IS ABSOLUTELY NECESSARY THAT THE NEW OWNER GET POSSESSION OF THE KEY WITH THE BROWN GRIP (AS WELL AS ALL OTHER KEYS) AND THE «CODE CARD»

Programming the immobilizer system

Below is described the procedure to follow for programming the **PIAGGIO IMMOBILIZER** system and/or for storing other key codes.

Procedure start - brown key

Insert the brown key into the key switch (in the «**OFF**» position), turning it to the «**ON**» position. After 1 - 3 seconds, turn the key to "**OFF**" again and pull it out.

Intermediate step - black key

After extracting the brown key, insert the black key within 10 seconds and promptly turn it to «**ON**». After 1-3 seconds, turn the key to "**OFF**" again and pull it out.

In this way, a maximum of 3 black keys can be programmed by repeating the above procedure keeping the indicated times.

Final step - brown key

After extracting the last black key, insert the brown key again and turn it to «**ON**» (carry out this operation within 10 seconds after extracting the previous key). Leave it in this position for 1 to 3 seconds and return it to the «**OFF**» position.

Proper programming check

Insert the brown key disabling the transponder (i.e., by tilting the key hood by 90°), and turn the key to «**ON**». Perform the engine start-up operation. Ensure that the engine does not start. Insert the black key and repeat the start-up operation. Check that the engine does start.

N.B.

IF THE ENGINE STARTS WITH THE BROWN KEY (AND WITH A DISABLED TRANSPONDER) OR IF DURING THE PROGRAMMING A WRONG STEP HAS BEEN CARRIED OUT, IT IS NECESSARY TO REPEAT THE PROCESS FROM THE BEGINNING.

Opening the saddle (01_12)

Insert the key into the saddle lock «**A**», turn it anticlockwise and tip the saddle forward.





01_13



01_14



01_15

Identification (01_13, 01_14)

The identification numbers consist of a prefix stamped on the chassis and on the engine, followed by a number. They should always be given when requesting spare parts. We recommend that you check that the prefix and chassis number stamped on the vehicle correspond with those in the vehicle documents.

CAUTION



BE REMINDED THAT ALTERING IDENTIFICATION REGISTRATION NUMBERS CAN LEAD TO SERIOUS PENAL SANCTIONS (IMPOUNDING OF THE VEHICLE, ETC.).

Rear top box opening (01_15)

Turn the key to the position «OFF». Then press it. With the key in «LOCK» the glove-box is locked.

Bag clip (01_16)

To use the retractable bag hook «**B**» located at the front end of the saddle, pull it forward lightly.

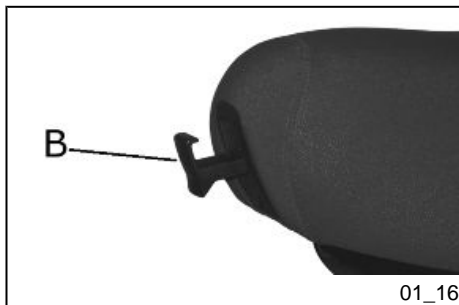

Vespa LX 125 150 4T

Vespa®



**Chap. 02
Use**

Checks

Before using the vehicle, check:

1. that the fuel tank is full.
2. The oil level in the rear hub.
3. engine oil level (see section «Engine oil level»).
4. That tyres are properly inflated.
5. correct functioning of headlights, rear taillight and turn indicators.
6. The correct functioning of the front and rear brakes.

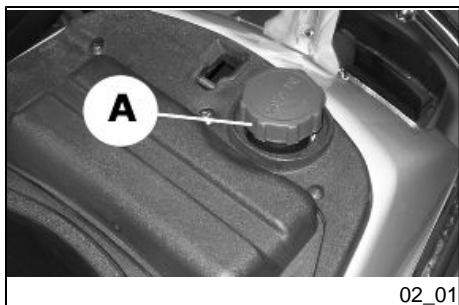

02_01

Refuelling (02_01)

Fill fuel tank«A» with unleaded petrol (minimum octane rating = 95).

When the fuel reaches the reserve level, the warning light fitted on the instrument panel lights up.

CAUTION



SHUT OFF THE ENGINE BEFORE REFUELLING WITH PETROL. PETROL IS HIGHLY FLAMMABLE. DO NOT LET PETROL SPILL FROM THE TANK OR WHILE REFUELLING

CAUTION



DO NOT BRING NAKED FLAMES OR CIGARETTES NEAR THE MOUTH OF THE FUEL TANK: FIRE HAZARD. ALSO AVOID INHALING HARMFUL VAPOURS.

CAUTION

USING OILS OTHER THAN THOSE RECOMMENDED CAN SHORTEN THE LIFE OF THE ENGINE.

Characteristic**Fuel tank capacity**

~ 8.5 l (2 l of which is reserve)

Tyre pressure**CAUTION**

TYRE PRESSURE SHOULD BE CHECKED WHEN TYRES ARE COLD. INCORRECT TYRE PRESSURE CAUSES ABNORMAL TYRE WEAR AND MAKES RIDING DANGEROUS.

TYRES MUST BE REPLACED WHEN THE TREAD REACHES THE WEAR LIMITS SET FORTH BY LAW.

Characteristic**Front tyre pressure**

1.6 bar

Rear tyre pressure

2 bar

Rear wheel pressure (rider and passenger):

2.3 bar

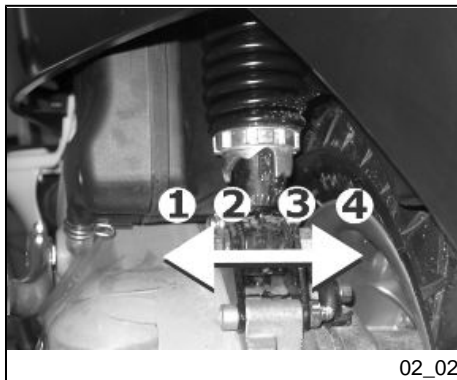

02_02

Shock absorbers adjustment (02_02)

The preloading of the springs can be adjusted to 4 positions using the ring nut located in the lower part of the shock absorbers and the specific spanner supplied.

Position 1: minimum preload: driver only

Position 2 medium preloading: driver only

Position 3 medium preloading: rider and passenger

Position 4: maximum preloading: driver, passenger, and luggage.

In order to carry out this operation you will need to use the specific spanner in the kit.

CAUTION



RIDING THE VEHICLE WITH THE SPRING PRELOADING NOT CORRECTLY SET FOR THE RIDER AND POSSIBLE PASSENGER, COULD REDUCE THE COMFORT OF THE RIDE AND THE PRECISION OF THE STEERING.

WARNING



WE RECOMMEND WEARING GLOVES WHILE CARRYING OUT THIS OPERATION IN ORDER TO AVOID INJURIES.

Running in (02_03)

WARNING



DURING THE FIRST 1000 KM DO NOT RIDE THE VEHICLE OVER 80% OF ITS MAXIMUM SPEED. AVOID TWISTING THE THROTTLE GRIP FULLY OR KEEPING A CONSTANT SPEED ALONG LONG SECTIONS OF ROAD. AFTER THE FIRST 1000 KM, GRADUALLY INCREASE SPEED UNTIL REACHING THE MAXIMUM PERFORMANCE.



02_03

Starting up the engine (02_04)

The scooter is fitted with automatic transmission with a regulator and centrifugal clutch. Therefore always start the engine with the throttle at a minimum; to start-off from still, progressively twist the throttle grip.

The vehicle is equipped with a fuel valve and a starter that switch on automatically as soon as the engine is started.

In order to start the engine, it is necessary to pull either the rear brake lever "B" or the front brake lever "C", before pressing the starting button, "A", so as to disengage the safety switches.

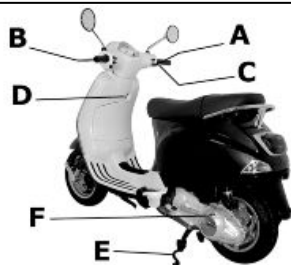

02_04

1: Put the motorscooter on its stand "E"; check that the rear tire is off the ground.

2: Keep the throttle closed.

3: Insert the key into the ignition switch, "D", and turn to the **ON** position.

4: Push the starter button «A» after pulling the rear brake lever «B» or the front brake lever «C».

CAUTION

DO NOT CARRY OUT THESE OPERATIONS IN CLOSED AREAS SINCE EXHAUST GASES ARE TOXIC.

CAUTION

DUE TO THE HIGH TEMPERATURES THE CATALYTIC CONVERTER CAN REACH, ALWAYS TAKE CARE, WHEN PARKING THE SCOOTER, THAT THE EXHAUST DOES NOT COME INTO CONTACT WITH FLAMMABLE MATERIALS, TO AVOID SERIOUS BURNS.

Precautions**CAUTION**

NEVER STRESS THE ENGINE AT LOW TEMPERATURES IN ORDER TO AVOID POSSIBLE DAMAGE. BE CAREFUL NEVER TO EXCEED THE MAXIMUM SPEED WHILE RUNNING DOWNHILL, IN ORDER TO AVOID DAMAGING THE ENGINE. IN ANY CASE, IN ORDER TO PRESERVE THE ENGINE FROM PROLONGED EXCESSIVE REVOLUTIONS, THE REVOLUTION LIMITER WILL BE ACTIVATED IF THE ENGINE SPEED EXCEEDS THE ESTABLISHED THRESHOLD.

WARNING

AFTER A LONG DISTANCE COVERED AT THE MAXIMUM SPEED, DO NOT STOP THE ENGINE IMMEDIATELY, BUT LET IT RUN AT IDLE FOR A FEW SECONDS.

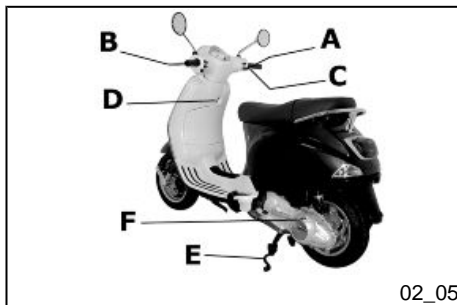

02_05

Difficult start up (02_05)

If there is a problem you can follow the instructions below:

1. Carburettor flooded. Place the vehicle on the centre stand and check that the rear tyre is off the ground. Open the throttle fully and press the starter button for five seconds and then stop for five seconds. If the engine does not start after a few attempts, let the engine sit for a few minutes and then repeat the above operations. In any case do not operate the starter longer than 20" in the attempt to start the engine.

2. Battery or starter motor inefficiency. Put the motorscooter on its stand "E"; make sure that the rear wheel is off the ground, turn the key switch «D» to «ON» and use the kick-starter «F».

3. Empty fuel tank. After refuelling the scooter, start the engine by pressing the starter button «A» with the throttle at a minimum to provide maximum aspiration for the tap. If the scooter fails to start even after taking the steps described above, contact an **Authorised Piaggio Service Centre**.

CAUTION



ALWAYS PLACE THE VEHICLE ON ITS STAND BEFORE KICK STARTING.

WARNING



TAMPERING MAY CAUSE SERIOUS ENGINE MALFUNCTION.

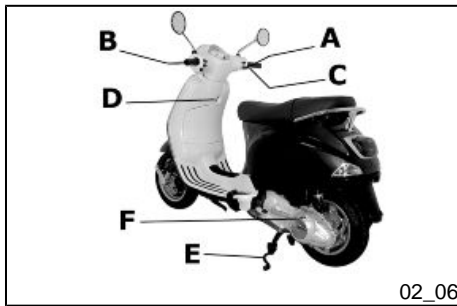

Stopping the engine (02_06)

Stop acceleration, then turn the key switch "D" to "OFF" to turn off the engine (extractable key).

CAUTION



DUE TO THE HIGH TEMPERATURES THE CATALYTIC CONVERTER CAN REACH, ALWAYS TAKE CARE, WHEN PARKING THE SCOOTER, THAT THE EXHAUST DOES NOT COME INTO CONTACT WITH FLAMMABLE MATERIALS, TO AVOID SERIOUS BURNS.

Automatic transmission

To ensure simple, pleasurable riding, the vehicle is equipped with automatic transmission with regulator and centrifugal clutch. The system is designed to give the best possible performance in terms of both acceleration and consumption, on level ground and uphill, thanks to the adjustments made to engine speed and transmitted torque. If you have to stop on an uphill slope (traffic lights, traffic jam, etc.) only use the brake to keep the vehicle still, leaving the motor running at idling speed. Using the motor to keep the vehicle still can cause the clutch to overheat. This problem is due to the friction of the clutch parts on the clutch bell. It is therefore recommended to avoid conditions of prolonged clutch slippage leading to clutch overheating (for example, as well as the situation described above, riding uphill fully laden on steep slopes or starting off on slopes greater than 25%, etc.):

1. Do not continue riding in such conditions.
2. Let the clutch cool down with the motor at idling speed for a few minutes.

Safe driving

WARNING



SOME SIMPLE TIPS ARE PROVIDED BELOW THAT WILL ENABLE YOU TO USE YOUR SCOOTER ON A DAILY BASIS IN GREATER SAFETY AND WITH MORE PEACE OF MIND.

<

Your ability and your knowledge of the vehicle form the basis of safe riding. We recommend trying out the vehicle in traffic-free zones to get to know your vehicle completely.

ALWAYS DRIVE WITHIN YOUR LIMITS

1. Before riding off, remember to put on your helmet and fasten it correctly.
2. Reduce speed and ride cautiously on uneven roads.
3. Remember that after riding on a long stretch of wet road without using the brakes, the braking effect is initially lower. Given these conditions, it is a good idea to operate the brakes from time to time.
4. Do not brake hard on a wet surface, on dirt tracks or on any slippery road surface.
5. If you have to brake, use both brakes in order to divide the braking action between both wheels.
6. Avoid starting off by mounting the scooter while it is still resting on its stand. In any case, the rear wheel should not be turning when it comes into contact with the ground, in order to avoid abrupt departures.
7. If the vehicle is used on roads covered with sand, mud, snow mixed with salt, etc., clean the brake disc frequently with mild detergent in order to prevent abrasive substances from building up within the holes, which can result in early wear of the brake pads.

8. Any elaboration that modifies the vehicle's performances, such as tampering with original structural parts is strictly forbidden by law, and renders the vehicle not conforming to the approved type and therefor dangerous to ride.

CAUTION

DO NOT FORGET THAT DRIVING IN A STATE OF DRUNKENNESS, OR WHEN UNDER THE EFFECT OF DRUGS OR CERTAIN MEDICINES, CAN BE EXTREMELY DANGEROUS FOR ONESELF AND FOR OTHERS.

CAUTION

ANY CHANGES TO THE VEHICLE PERFORMANCE AS WELL AS ALTERATIONS TO ORIGINAL STRUCTURAL PARTS IS STRICTLY FORBIDDEN BY LAW, AND RENDERS THE VEHICLE NO LONGER CONFORMING TO THE APPROVED TYPE AND DANGEROUS FOR RIDING.

Vespa LX 125 150 4T

Vespa®



**Chap. 03
Maintenance**

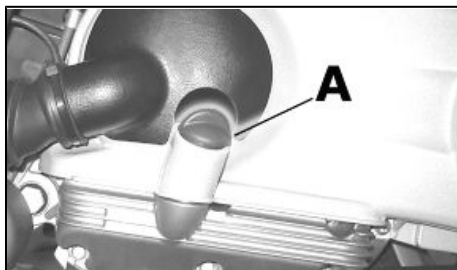

03_01

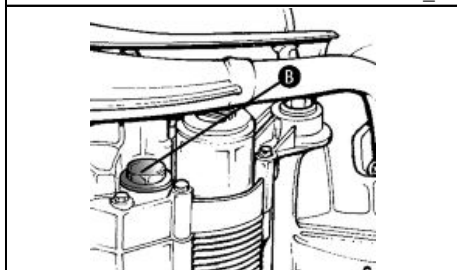

03_02

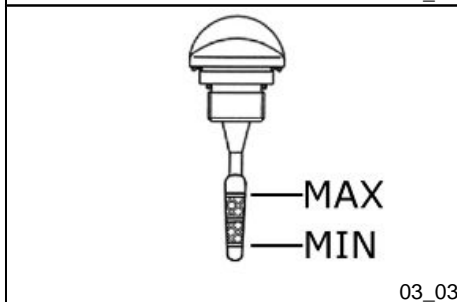

03_03

Engine oil level (03_01)

In 4T engines, engine oil is used to lubricate the distribution elements, main bearings and thermal group. **An insufficient quantity of oil can cause serious damage to the engine itself.** In all four-stroke engines, a loss of efficiency in oil performance and consumption should be considered normal. Consumption can particularly reflect the conditions of use (i.e. when driving at "full acceleration" all the time, oil consumption increases). The replacement frequencies provided for by the maintenance programme are defined, depending on the total contents of oil in the engine and average consumption measured following standardised methods. **In order to prevent any problems, we recommend checking oil level more frequently than indicated in the Scheduled Maintenance table or before setting off on long journeys. The vehicle is, however, equipped with an oil pressure warning light on the instrument panel.**

Engine oil level check

Every time the scooter is used, a visual check should be made on the level of the engine oil when the engine is cold. The oil level should be somewhere between the **MAX** and **MIN** index marks on the level bar; the check **MUST** be made with the scooter upright, resting on the centre stand.

If the check is carried out after the vehicle has been used, and therefore with a hot engine, the level line will be lower; in order to carry out a correct check, wait at least 10 minutes after the engine has been stopped so as to get the correct level.

CAUTION



USING THE ENGINE WITH INSUFFICIENT LUBRICATION OR WITH THE WRONG LUBRICANTS MAY INCREASE WEAR AND TEAR ON THE MOVING PARTS AND MAY CAUSE SERIOUS DAMAGE.

Characteristic

Engine oil

1100 cm³

Engine oil top-up

Always check oil level before carrying out top-ups and add oil **without exceeding the MAX level**. An engine oil check-up and top-up should be carried out every 3,000 km at an **Authorised Piaggio Service Centre**.

Warning light (insufficient oil pressure)

The vehicle is equipped with a warning light that lights up when the key is turned to the «ON». However, this light should switch off once the engine has been started. **If the light comes on while braking, at idle speed or while turning a corner, it is necessary to check the oil level and top it up if required. If after having topped-up the oil, the warning light still comes on while braking, at idle speed or while turning a corner, it will be necessary to take your vehicle to an Authorised Service Centre.**

Engine oil change (03_02, 03_03)

Oil must be changed and filter replaced at an **Authorised Service Centre** (as indicated in the Scheduled Maintenance Table). The engine should be emptied by draining the oil from the drainage plug «B » of the gauze filter on the flywheel side. In order to facilitate oil drainage, loosen the cap/dipstick «A». Since a certain quantity of oil remains in the circuit still, the top-up should be carried out from the cap «A».

Then start up the scooter, leave it running for a few minutes and switch it off: after about five minutes check the level and if necessary top up **without exceeding the MAX level**.

The cartridge filter must be replaced every time the oil is changed. For top-ups and changes use new oil of the recommended type.

WARNING



RUNNING THE ENGINE WITH INSUFFICIENT LUBRICATION OR WITH INADEQUATE LUBRICANTS ACCELERATES THE WEAR AND TEAR OF THE MOVING PARTS AND CAN CAUSE IRRETRIEVABLE DAMAGE.

CAUTION

USED OILS CONTAIN SUBSTANCES HARMFUL TO THE ENVIRONMENT. FOR OIL REPLACEMENT, CONTACT AN AUTHORISED SERVICE CENTRE, WHICH IS EQUIPPED TO DISPOSE OF USED OILS IN AN ENVIRONMENTALLY FRIENDLY AND LEGAL WAY.

Recommended products**AGIP CITY HI TEC 4T**

Engine oil

SAE 5W-40, API SL, ACEA A3, JASO MA Synthetic oil

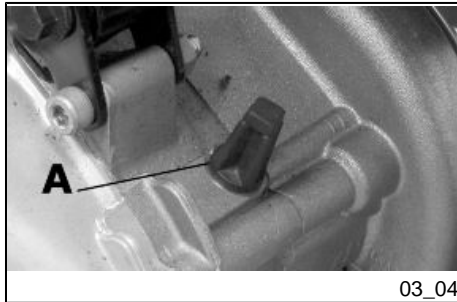
**Hub oil level (03_04, 03_05, 03_06)**

Check that there is oil in the rear hub. Proceed as follows in order to check the hub oil level:

- 1) Place the vehicle on its central stand on a level surface.
- 2) Unscrew the oil bar «A», dry it with a clean cloth and reinsert it, **screwing it in completely.**
- 3) Remove the dipstick and make sure the oil level is between MIN and MAX. If the level is under MIN, the correct amount of oil needs to be added to the hub.
- 4) Screw the bar back in, checking that it is tightly in place.

N.B.

THE REFERENCE MARKS ON THE HUB OIL LEVEL DIPSTICK, EXCEPT FOR THE ONE INDICATING THE "MAX" LEVEL, REFER TO OTHER MODELS BY THE MANUFACTURER AND HAVE NO SPECIFIC FUNCTION FOR THIS MODEL.

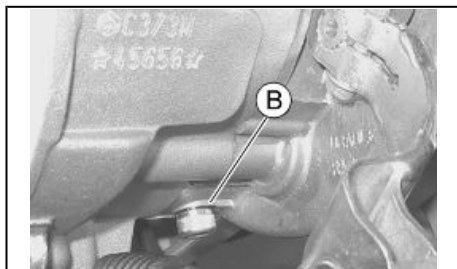

03_05

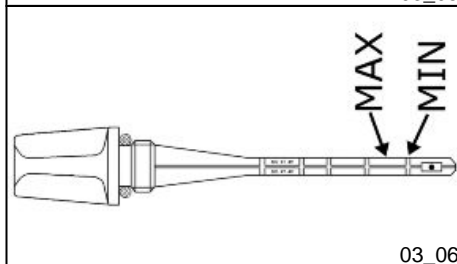

03_06

CAUTION

RIDING THE VEHICLE WITH INSUFFICIENT HUB LUBRICATION OR WITH CONTAMINATED OR IMPROPER LUBRICANTS ACCELERATES THE WEAR AND TEAR OF THE MOVING PARTS AND CAN CAUSE SERIOUS DAMAGE.

CAUTION

USED OILS CONTAIN SUBSTANCES HARMFUL TO THE ENVIRONMENT. FOR OIL REPLACEMENT, CONTACT AN AUTHORISED SERVICE CENTRE, WHICH IS EQUIPPED TO DISPOSE OF USED OILS IN AN ENVIRONMENTALLY FRIENDLY AND LEGAL WAY.

Recommended products**AGIP ROTRA 80W-90**

Rear hub oil

SAE 80W/90 Oil that exceeds the requirements of API GL3 specifications

Characteristic**Hub oil**

Capacity ~ 100 cc

REPLACEMENT

- 1) Remove the dipstick.
- 2) Unscrew the oil drainage screw «B» and drain out all the oil.
- 3) Screw back the drainage screw and refill the hub using the recommended oil quantity and type.

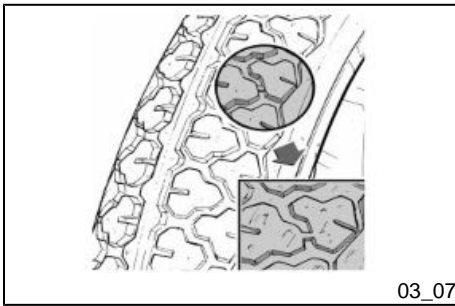

03_07

Tyres (03_07)

Periodically check the inflation pressure of each tyre (when cold).

Tyres are fitted with wear indicators; tyres should be replaced as soon as these indicators become visible on the tyre tread. Also check that the tyres do not show signs of splitting at the side or irregular tread wear; If this occurs, go to an authorised workshop or at least a workshop equipped to perform the removal and the refitting.

CAUTION



TYRE PRESSURE SHOULD BE CHECKED WHEN TYRES ARE COLD. INCORRECT TYRE PRESSURE CAUSES ABNORMAL TYRE WEAR AND MAKES RIDING DANGEROUS.

TYRES MUST BE REPLACED WHEN THE TREAD REACHES THE WEAR LIMITS SET FORTH BY LAW.

Characteristic

Front tyre pressure

1.6 bar

Rear tyre pressure

2 bar

Rear wheel pressure (rider and passenger):

2.3 bar



03_08



03_09



03_10

Spark plug dismantlement (03_08, 03_09, 03_10, 03_11)

In order to inspect the spark plug, follow the operation described when the engine is cold:

1. Lift the saddle and remove the helmet compartment "A";
2. Remove the spark plug inspection door "B";
3. Detach the spark plug cap;
4. slide the door «C» on the engine cover upwards;
5. Remove the spark plug with the supplied spanner "D" (with retaining rubber).

To refit, repeat the procedure in reverse order using the spanner to insert the spark plug or to tighten it in its seat. Care should be taken to installing and fixing it with correct inclination

Be extremely careful when carrying out the operations described above, insert your left hand on the spark plug inspection door side and your right hand from the helmet compartment side.

To refit the door follow the steps in reverse order, making sure to insert the pin in the central cover.

WARNING



THE SPARK PLUG MUST BE REMOVED WHEN THE ENGINE IS COLD. THE USE OF A SPARK PLUG WITH THERMAL GRADE OR THREAD OTHER THAN THE INDICATED TYPE (SEE «DATA» SECTION) CAN SERIOUSLY DAMAGE THE ENGINE. REPLACE SPARK PLUGS AT THE INTERVALS INDICATED IN THE SCHEDULED MAINTENANCE TABLE.

N.B.

THE USE OF SPARK PLUGS OTHER THAN THE INDICATED TYPE OR OF SHIELDLESS SPARK PLUG CAPS CAN CAUSE ELECTRICAL SYSTEM FAILURES.



03_11

Characteristic

Spark plug

CHAMPION RG6YC - NGK CR7EB

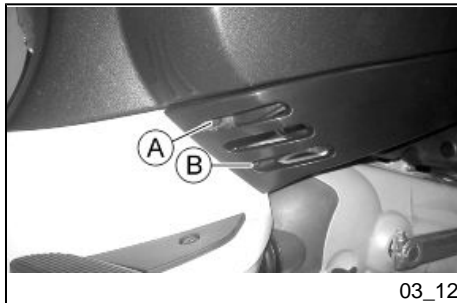

03_12

Removing the air filter (03_12, 03_13)

Remove the side fairing unscrewing the 2 screws marked **A**. Remove the air cleaner cap «**D**» after unscrewing the 6 fixing screws «**C**», then remove the filtering element. Clean with water and shampoo, afterwards dry with compressed air and submerge in a recommended oil and petrol mixture in ratio of 50%. Afterwards squeeze it, leave it to dry and mount it again.

CAUTION



IN CASE OF RIDING ON DUSTY ROADS IT IS ADVISABLE TO CLEAN THE AIR FILTER MORE FREQUENTLY THAN INDICATED IN THE RELEVANT CHAPTER ON SCHEDULED MAINTENANCE.

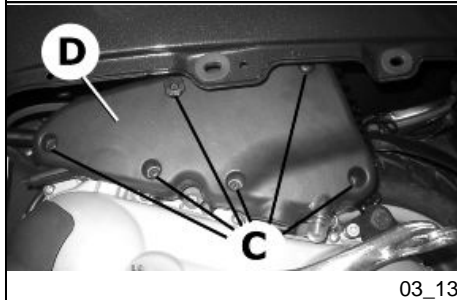

03_13

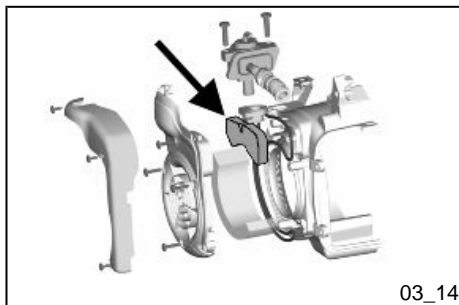

Secondary air system (03_14)

In order to reduce polluting emissions, the vehicle is furnished with a catalytic converter in the muffler.

To favour the catalytic process, an extra amount of oxygen is added via a secondary air system (SAS).

This system allows more oxygen to be added to the unburned gases before they reach the converter, thus improving the action of the catalytic converter.

The air enters the exhaust duct from the head, and is purified by a black filter.

The system is fitted with a control valve that disables operation while decelerating to avoid unwanted noise.

To ensure the best functioning of the SAS system, every 12,000 km the scooter should be taken to an **Authorised Piaggio Service Centre** to have the filter cleaned (Scheduled maintenance operations section).

The filter sponge should be cleaned with water and mild soap, then it should be dried with a cloth and slight blows of compressed air.

CAUTION



CONTACT AN AUTHORISED PIAGGIO SERVICE CENTRE TO CARRY OUT THESE OPERATIONS.

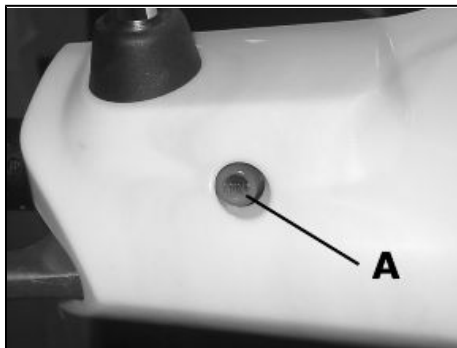

03_15

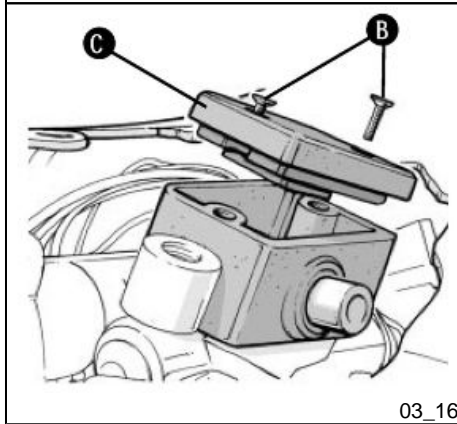

03_16

Checking the brake oil level (03_15, 03_16)

The brake fluid reservoir is equipped with a sight glass «A» made of transparent material; the quantity of liquid contained in the sight glass indicates the level of liquid in the reservoir.

When the sight glass «A» is full, the level inside the reservoir exceeds the MIN level; when it is partially full, the level drops to the MIN level; when it is fully empty, the level of fluid in the reservoir is below the MIN level.

The brake fluid level may fall due to wear on the brake pads. In case the pad wear is below the minimum mark, contact an **Authorised Service Centre** to have the braking system thoroughly checked. If you need to top up the level, follow the steps listed below. Unscrew the 2 screws "B", remove the tank cap "C" and pour in the required quantity of fluid (the brake fluid level must be above minimum). Place the handlebar in the riding position and pay attention not to tilt the vehicle in order to keep the brake fluid reservoir in horizontal position when checking the fluid level.

CAUTION



TOP UPS SHOULD ONLY BE CARRIED OUT WITH DOT 4 CLASSIFIED BRAKE FLUID.

WARNING



IN NORMAL CLIMATIC CONDITIONS IT IS ADVISABLE TO REPLACE THE ABOVE-MENTIONED FLUID EVERY 2 YEAR. NEVER USE BRAKE FLUID CONTAINED IN CONTAINERS WHICH ARE ALREADY OPEN OR PARTIALLY USED.

CAUTION



THE BRAKING CIRCUIT FLUID IS HIGHLY CORROSIVE. THEREFORE, WHEN TOPPING IT UP, AVOID LETTING IT COME INTO CONTACT WITH THE PAINTED

PARTS OF THE VEHICLE. THE BRAKING CIRCUIT FLUID IS HYGROSCOPIC, WHICH MEANS THAT IT ABSORBS MOISTURE FROM THE SURROUNDING AIR. IF MOISTURE CONTAINED IN THE BRAKE FLUID EXCEEDS A CERTAIN VALUE, THIS WILL RESULT IN INEFFICIENT BRAKING.

Battery (03_17)

To access the battery, tilt the saddle forwards, then remove the battery compartment access door by unscrewing the star-shaped screw "A" shown in the figure.

The battery is the electrical device that requires the most frequent attention and the most thorough maintenance.

WARNING



SPENT BATTERIES ARE HARMFUL FOR THE ENVIRONMENT. COLLECTION AND DISPOSAL SHOULD BE CARRIED OUT IN COMPLIANCE WITH CURRENT REGULATIONS.

CAUTION



ELECTROLYTE CONTAINS SULPHURIC ACID: AVOID CONTACT WITH EYES, SKIN AND CLOTHES. IN THE CASE OF ACCIDENTAL CONTACT, RINSE WITH ABUNDANT OF WATER AND CONSULT A DOCTOR.

CAUTION



IN ORDER TO AVOID DAMAGING THE ELECTRICAL SYSTEM, NEVER DISCONNECT THE WIRING WHILE THE ENGINE IS RUNNING. DO NOT TIP THE SCOOT-

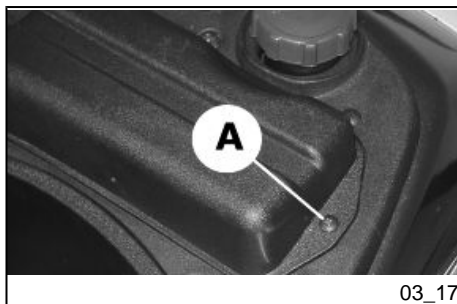

ER TOO MUCH IN ORDER TO AVOID DANGEROUS LEAKAGE OF BATTERY ELECTROLYTE

Checking the electrolyte level

The electrolyte level, which should be checked regularly, must always be at the maximum level. To reach this level, use only distilled water. Should it become necessary to top up the battery with water too frequently, check the scooter's electrical system because the battery is being overloaded, causing it to lose power quickly.

CAUTION



ELECTROLYTE CONTAINS SULPHURIC ACID: AVOID CONTACT WITH EYES, SKIN AND CLOTHES. IN THE CASE OF ACCIDENTAL CONTACT, RINSE WITH ABUNDANT OF WATER AND CONSULT A DOCTOR.

Long periods of inactivity

Battery performance will decrease if the vehicle is not used for a long time. This is the result of the natural phenomenon of battery discharging plus residual absorption by vehicle components with constant power consumption. Poor battery performance may also be due to environmental conditions and the cleanness of the poles. In order to avoid difficult starts and/or irreversible damage to the battery, follow any of these steps:

- **At least once a month** start the engine and run it slightly above idle speed for 10-15 minutes. This keeps all the engine components, as well as the battery, in good working order.
- Take your vehicle to a garage (as indicated in the "Vehicle not used for extended periods" section) to have the battery removed. Have the battery cleaned, charged fully and stored in a dry, ventilated place. Recharge **at least once every two months**.

N.B.

THE BATTERY MUST BE CHARGED WITH A CURRENT EQUAL TO 1/10 OF THE RATED CAPACITY OF THE BATTERY AND FOR NOT LONGER THAN 10 HOURS. CONTACT AN AUTHORISED SERVICE CENTRE TO CARRY OUT THIS OPERATION SAFELY. WHEN REFITTING THE BATTERY MAKE SURE THE LEADS ARE CORRECTLY CONNECTED TO THE TERMINALS.

WARNING



DO NOT DISCONNECT THE BATTERY CABLES WITH THE ENGINE RUNNING, THIS CAN CAUSE PERMANENT DAMAGE TO THE VEHICLE ELECTRONIC CONTROL UNIT.

WARNING



SPENT BATTERIES ARE HARMFUL FOR THE ENVIRONMENT. COLLECTION AND DISPOSAL SHOULD BE CARRIED OUT IN COMPLIANCE WITH CURRENT REGULATIONS.

Fuses (03_18, 03_19)

The electrical system is protected by two 15A fuses «B» located next to the battery and by two 7,5 A fuses «A» located under the front grille.

CAUTION



IN ORDER TO AVOID DAMAGING THE ELECTRICAL SYSTEM, NEVER DISCONNECT THE WIRING WHILE THE ENGINE IS RUNNING. DO NOT TIP THE SCOOTER TOO MUCH IN ORDER TO AVOID DANGEROUS LEAKAGE OF BATTERY ELECTROLYTE



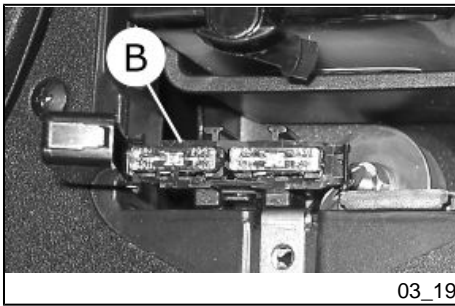

03_19

CAUTION

MODIFICATIONS OR REPAIRS TO THE ELECTRICAL SYSTEM, PERFORMED INCORRECTLY OR WITHOUT STRICT ATTENTION TO THE TECHNICAL SPECIFICATIONS OF THE SYSTEM, CAN CAUSE ERRORS IN FUNCTIONING AND RISK OF FIRE.

CAUTION

BEFORE REPLACING THE BLOWN FUSE, FIND AND SOLVE THE FAILURE THAT CAUSED IT TO BLOW. NEVER TRY TO REPLACE THE FUSE WITH ANY OTHER MATERIAL (E.G., A PIECE OF ELECTRIC WIRE).

LIGHT BULBS

High/low beam light bulb	Type: Halogen (H4) Power: 12V - 55/60W Quantity: 1
--------------------------	---

Front tail light bulb	Type: All glass Power: 12V 5W Quantity: 1
-----------------------	--

Front turn indicator bulb	Type: Spherical Power: 12V - 10W
---------------------------	---

	Quantity: 1 RHS + 1 LHS
Rear turn indicator light bulb	Type: Spherical Power: 12V - 10W Quantity: 1 RHS + 1 LHS
Stop and tail light bulb	Type: Spherical Power: 12V 21/5W Quantity: 1
Warning light bulbs 12V - 2W	Type: Bayonet Function: Turn signals, engine oil Quantity: 3
Pilot light bulbs 12V - 1,2W	Type: BAYONET Voltage supply/Power: Lights, high beams, reserve level, engine oil Quantity: 4
Dashboard light bulbs	Type: Bayonet Power: 12V 1.2W Quantity: 3
License plate light bulb	Type: ALL GLASS Power: 12V - 5W Quantity: 1

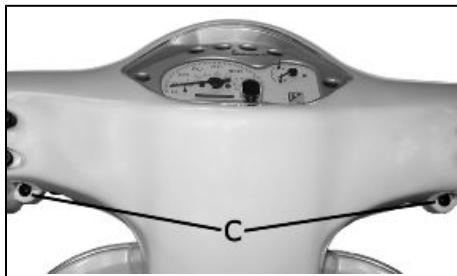

03_20

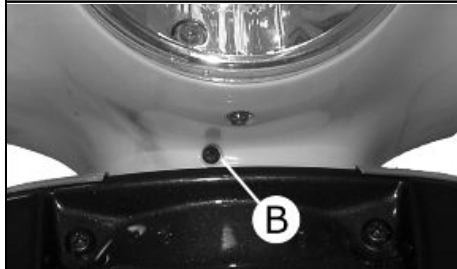

03_21

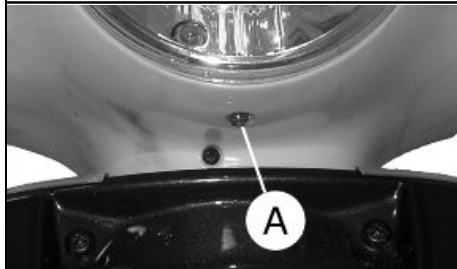

03_22

Front light group (03_20, 03_21)

To access the headlight bulbs, remove the front of the handlebar cover, as follows:

- 1) Remove the rear-view mirrors; for this operation follow the instructions described and illustrated in «Rear-view mirrors» section.
- 2) Unscrew the 3 screws holding the handlebar cover. The front central one «B» and the rear 2 «C». Once this is done, the handlebar cover can be removed.
- 3) Remove the handlebar cover to access the headlight and the bulbs.

N.B.

IF MISTING IS NOTICED ON THE INSIDE OF THE HEADLAMP GLASS, THIS DOES NOT INDICATE A FAULT AND IS RELATED TO THE HUMIDITY AND/OR TO LOW TEMPERATURES.

THE PHENOMENON SHOULD QUICKLY DISAPPEAR WHEN THE LIGHT IS SWITCHED ON.

THE PRESENCE OF DROPS OF WATER, ON THE OTHER HAND, COULD INDICATE THAT WATER IS INFILTRATING. CONTACT THE PIAGGIO AFTER-SALES SERVICE NETWORK.

Electric characteristic

Bulbs

1 piece 12V/55-60W bulb for high- and low-beam light

1 piece 12V/5W bulb for taillights

Headlight adjustment (03_22, 03_23)

Proceed as follows:

1. Place the vehicle in running order and with the tyres inflated to the prescribed pressure, on a flat surface 10 m away from a white screen situated in a shaded area, making sure that the longitudinal axis of the scooter is perpendicular to the screen;

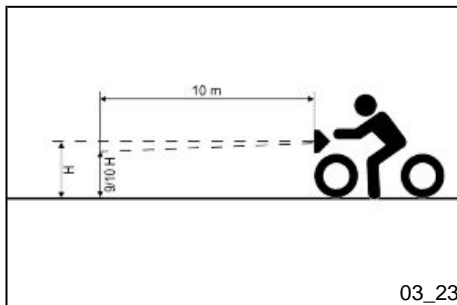

2. Turn on the headlight and check that the borderline of the projected light beam on the screen is not lower than 9/10 of the distance from the ground to the centre of vehicle headlamp and higher than 7/10;

3. If otherwise, adjust the right headlight with screw «A».

N.B.

THE ABOVE PROCEDURE COMPLIES WITH THE EUROPEAN STANDARDS REGARDING MAXIMUM AND MINIMUM HEIGHT OF LIGHT BEAMS. REFER TO THE STATUTORY REGULATIONS IN FORCE IN EVERY COUNTRY WHERE THE vehicle IS USED.

Front direction indicators (03_24)

To replace the front turn indicator bulbs, remove the tail light taking out the retaining screw "A", remove the bulb holder from its fitting; gently turn the bulb around 30° and remove it. Follow the process in reverse order to refit.

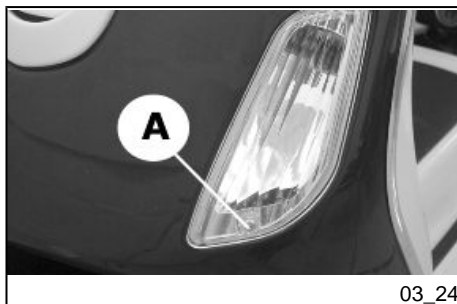

Rear optical unit (03_25)

To access the rear taillight bulb it is necessary to remove the 2 fixing screws «D». Gently push and turn the bulb about 30° and then remove it. To refit follow the same steps but in reverse order.

N.B.

IF MISTING IS NOTICED ON THE INSIDE OF THE HEADLAMP GLASS, THIS DOES NOT INDICATE A FAULT AND IS RELATED TO THE HUMIDITY AND/OR TO LOW TEMPERATURES.

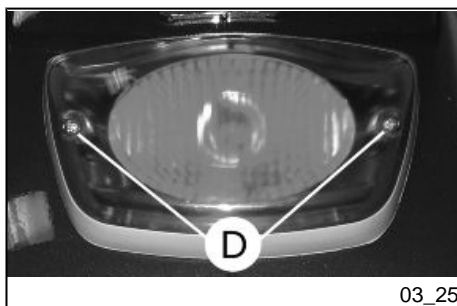



03_26

THE PHENOMENON SHOULD QUICKLY DISAPPEAR WHEN THE LIGHT IS SWITCHED ON.

THE PRESENCE OF DROPS OF WATER, ON THE OTHER HAND, COULD INDICATE THAT WATER IS INFILTRATING. CONTACT THE PIAGGIO AFTER-SALES SERVICE NETWORK.

Rear turn indicators (03_26)

To gain access to the turn indicator bulbs, remove the fastening screws «E».

The bulbs have a bayonet coupling, to remove them press gently and twist anticlockwise about 30°. To refit follow the same steps but in reverse order.

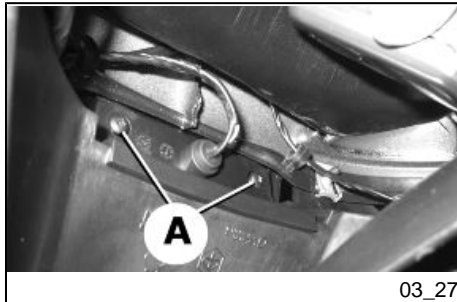

03_27

Number plate light (03_27, 03_28)

Reach the back of the license plate support.

Use a screwdriver to remove the 2 screws "A" and detach the license plate lamp cover.

Then remove the bulb "B"

Electric characteristic

License plate light bulb

12V - 5W

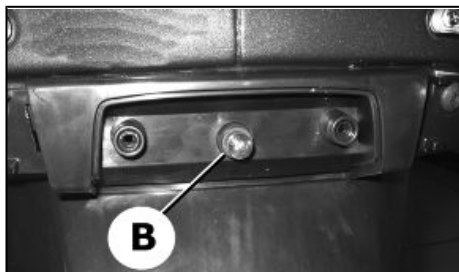

03_28

Rear-view mirrors (03_29)

The mirrors can be set to the desired position by adjusting the mirror frame.

To remove the rear-view mirror rotate the rear-view mirror support rod clockwise.

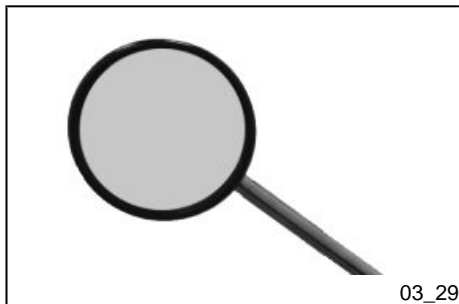

03_29

Idle adjustment (03_30)

Proceed as follows:

1. Rest the scooter on its centre stand and lift the saddle (as described in the «Saddle opening to reach helmet compartment» section).
2. Remove the helmet compartment.
3. To adjust the idle speed, start the engine, then loose or tighten the screw «B» until you reach the recommended idle speed taking care the engine does not make the rear wheel move.

If adjustment is difficult, take your vehicle to a **Dealer or an Authorised PIAGGIO Service Centre** to adjust **CO** to idle speed.

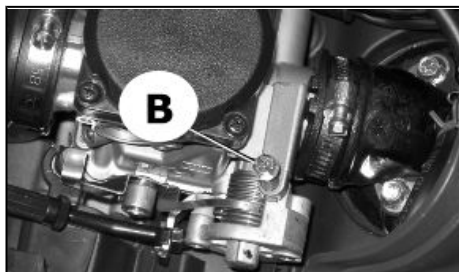

03_30

WARNING

IDLE SPEED MUST BE ADJUSTED WHEN THE ENGINE IS VERY HOT. BEFORE THIS OPERATION, MAKE SURE THAT THE THROTTLE GRIP HAS THE RECOMMENDED BACKLASH. IF BACKLASH IN THE THROTTLE CONTROL TRANSMISSION NEEDS ADJUSTING TAKE YOUR SCOOTER TO A PIAGGIO DEALER OR AUTHORISED SERVICE CENTRE

Characteristic**Engine idle speed**

approx. 1600 ÷ 1800 rpm

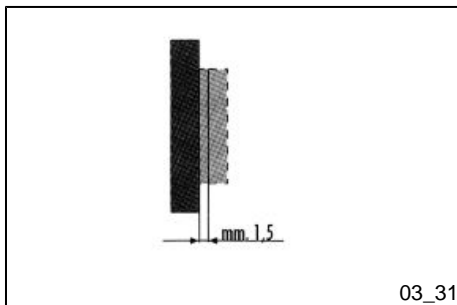
**Front disc brake (03_31)**

The brake disc and pad wear is automatically compensated, therefore it has no effect on the functioning of the front and rear brakes. For this reason it is not necessary to adjust the brakes. An excessively elastic brake lever stroke may indicate the presence of air in the braking circuit or an irregular brake operation. In this case, particularly considering the importance of the brakes in terms of safety, it is strongly recommended that you take the vehicle to an **Authorised Service Centre** as soon as possible for the appropriate checks.

WARNING

CHECK BRAKE PADS FOR WEAR ON A REGULAR BASIS (AS INDICATED IN THE SCHEDULE MAINTENANCE TABLES). IF THE THICKNESS OF ONE OR BOTH PADS IS IN THE REGION OF 1.5 MM, BOTH PADS MUST BE CHANGED. IT IS RECOMMENDED TO CARRY OUT THIS OPERATION AT AN AUTHORISED SERVICE CENTRE AS SOON AS POSSIBLE.

AFTER FITTING NEW BRAKE PADS DO NOT USE THE VEHICLE UNTIL YOU HAVE ACTIVATED THE BRAKE LEVER REPEATEDLY TO POSITION THE PADS AND RESTORE THE LEVER STROKE TO ITS CORRECT POSITION.

CAUTION



THE BRAKING ACTION SHOULD BEGIN AFTER ABOUT 1/3 OF THE BRAKE LEVER STROKE.

Rear drum brake (03_32)

Operate adjustment nut «**B**» and loosen lock nut «**A**» shown in the figure. Note that when the throttle is in idle **the wheel should rotate free**. After the adjustment, screw lock nut «**A**».

CAUTION



THE BRAKING ACTION SHOULD BEGIN AFTER ABOUT 1/3 OF THE BRAKE LEVER STROKE.

Puncture (03_33)

The vehicle is equipped with Tubeless tyres. When there is a puncture, Tubeless tyres - unlike tyres with inner tubes - go flat very slowly. This offers greater riding safety. A tyre that goes flat very slowly can be repaired with an "Inflate and Repair" spray. Tyres should be later fully repaired or replaced at an **Authorised Service Centre**.

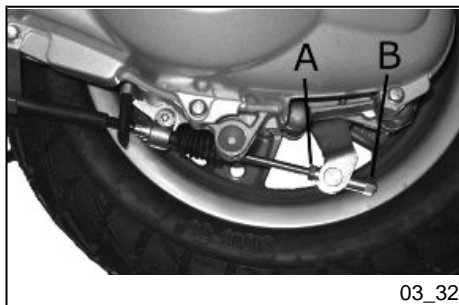

03_32



03_33



03_34

Periods of inactivity (03_34)

We recommend carrying out the following operations:

- 1 - General cleaning of the vehicle.
- 2 - With the engine off and the piston at bottom dead centre position, remove the spark plug and pour 1÷2 cc of motor oil through its hole. Operate the starter 3-4 times letting the engine perform a few revolutions, then remount the spark plug.
- 3 - Drain up all the vehicle's fuel; spread antirust grease on the unpainted metal parts; keep the wheels lifted above the ground.
- 4 - For the battery, follow the procedures described in the «Battery» section.
- 5 - Drain the petrol from the carburettor tank.
- 6 - Replace engine oil.

Recommended products

AGIP CITY HI TEC 4T

Oil to lubricate flexible transmissions (brakes, throttle control and odometer)
Oil for 4-stroke engines

Cleaning the vehicle

Use a low pressure jet of water to soften the caked dirt and mud deposited on the painted surfaces. Once softened, sponge off mud and dirt using a car body sponge soaked in a car body shampoo and water solution (2-4% of car shampoo in water). Then rinse abundantly with water, and dry with a shammy cloth. For the outside of the engine, use petroleum, a brush and clean cloths. Petrol can damage paintwork. Remember that any polishing with silicone wax must always be preceded by washing.

CAUTION

DETERGENTS POLLUTE WATER. THEREFORE THE VEHICLE SHOULD BE WASHED IN AN AREA EQUIPPED FOR THE COLLECTION AND PURIFICATION OF THE LIQUIDS USED.

WARNING

NEVER WASH THE VEHICLE UNDER DIRECT SUNLIGHT, ESPECIALLY IN SUMMER WHEN THE BODYWORK IS STILL HOT, AS THE CAR SHAMPOO MAY DRY BEFORE BEING RINSED OFF, AND COULD DAMAGE THE PAINTWORK. NEVER USE RAGS SOAKED IN PETROL OR DIESEL OIL TO CLEAN THE PAINTED OR PLASTIC SURFACES, TO PREVENT THEM LOSING THEIR SHINE AND MECHANICAL CHARACTERISTICS.

WARNING

WHEN WASHING THE ENGINE WITH A HIGH-PRESSURE WATER JET:

- **ONLY USE FAN SPRAY JETS.**
- **DO NOT PLACE THE WATER JET NOZZLE CLOSER THAN 60 CM.**
- **DO NOT USE WATER AT TEMPERATURES OVER 40° C.**
- **DO NOT DIRECT THE JETS DIRECTLY TO CARBURETTOR, WIRING, SLOT DIFFUSER ON THE TRANSMISSION COVER AND SCROLL COVER.**

DIFFICULT STARTING

No fuel in tank	Refuelling
Filters, jets or carburettor dirty or clogged.	Contact an Authorised Service Centre .
Insufficient battery charge	Recharge the battery.

IGNITION PROBLEM

No spark from spark plug. Due to the presence of high voltage, this check should only be carried out by an expert.	Check that the electrodes are properly adjusted (0.7- 0.8 mm). Check that the electrodes are clean (clean with pure petrol and metal brush or with emery cloth). Check the spark plug insulator: Replace the spark plug if the insulator is cracked or broken. If the spark plug is in good conditions, contact an Authorised Service Centre .
--	---

LACK OF COMPRESSION

Spark plug adapter "worn", valve clearance not adequate; worn piston gas rings	Contact an Authorised Service Centre .
--	---

HIGH CONSUMPTION AND LOW PERFORMANCE

Air filter blocked or dirty.	Clean with water and shampoo and impregnate with petrol and specific oil (section «Removing the air filter»)
------------------------------	--

INEFFICIENT BRAKING

Oil on drum or disc. Worn Pads/ Shoes	Contact an Authorised Service Centre
incorrect rear brake adjustment	Adjust

INEFFICIENT SUSPENSIONS

Inefficient shock absorbers, oil leakage, deteriorated end of stroke buffers.	Contact an Authorised Service Centre
---	---

IRREGULAR AUTOMATIC TRANSMISSION

Deteriorated variable speed rollers and/or driving belt and/or clutch	Contact an Authorised Service Centre
---	---

EXHAUST NOISE

Depression tube damaged/ disconnected or secondary valve damaged	Contact an Authorised Service Centre
--	---

STAND DOES NOT RETURN TO POSITION

Presence of dirt

Clean and grease

Vespa LX 125 150 4T

Vespa®



**Chap. 04
Technical data**

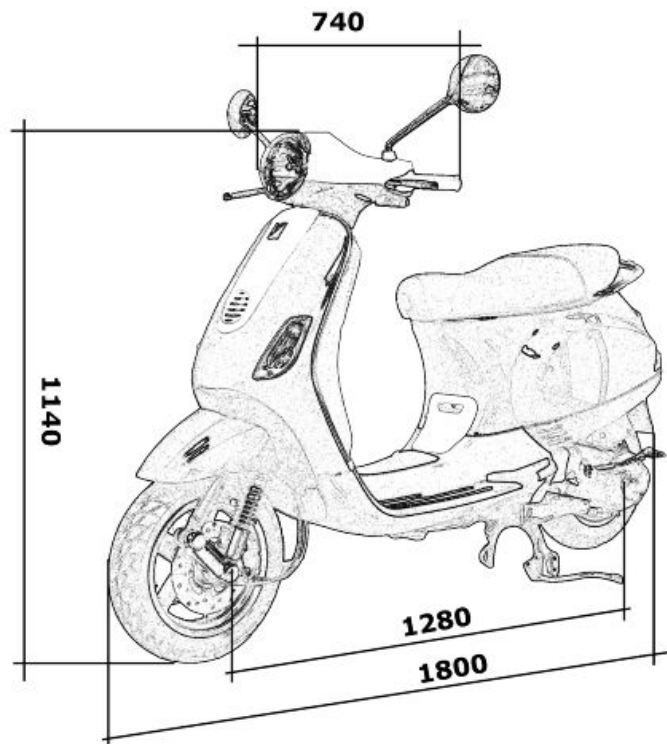

04_01

TECHNICAL SPECIFICATIONS 125

Engine	Single-cylinder, 4-stroke Piaggio LEADER
Cubic capacity	124 cc
Bore x stroke	57.0 x 48.6 mm
Length	1800 mm
Width	740 mm
Wheelbase	1280 mm
Overall height	1140 mm
Spark plug	CHAMPION RG6YC - NGK CR7EB
Carburettor	KEIHIN CVEK26
Valve clearance	intake 0.10 outlet 0.15
Fuel	Unleaded petrol
Fuel tank capacity	~ 8.5 l (2 l of which is reserve)
Timing system	Single overhead camshaft (SOHC) with 2 valves
Cooling	Forced air circulation.
Lubrication	Wet crankcase
Start-up	Electric
Transmission	Automatic speed variator CVT with torque server

Chassis	Unitised body made of stamped plate.
Clutch	Automatic centrifugal dry clutch
Steering and suspensions	Steering tube articulated on the front wheel carrier hub; helicoidal spring suspension and double-acting hydraulic shock absorber; rear with double-acting shock absorber and coaxial spring adjustable to 4 positions at preloading.
Front brake	Disc brake (Ø 200 mm) with hydraulic control (lever on the far right of the handlebar) and fixed calliper.
Rear brake	Ø110 mm drum brake
Front wheel rim	Die-cast aluminium alloy; 2.50 x11"
Rear wheel rim	Die-cast aluminium alloy; 3.00 x 10"
Front tyre	Tubeless; 110/70-11"
Rear tyre	Tubeless; 120/70-10"
Dry weight	110 ± 5

TECHNICAL SPECIFICATIONS 150

Engine	Single-cylinder, 4-stroke Piaggio LEADER
Cubic capacity	150,46 cm ³
Bore x stroke	62,6 x 48.6 mm

Overall height	1140 mm
Width	740 mm
Length	1800 mm
Wheelbase	1280 mm
Compression ratio	10.5: 1
Max. power	11.6 hp at 7750 rpm
Max. torque	11.6 Nm at 6000 rpm
Spark plug	CHAMPION RG6YC - NGK CR7EB
Carburettor	KEIHIN CVEK26
Valve clearance	intake 0.10 outlet 0.15
Fuel	Unleaded petrol
Fuel tank capacity	~ 8.5 l (2 l of which is reserve)
Timing system	Single overhead camshaft (SOHC) with 2 valves
Cooling	Forced air circulation.
Lubrication	Wet crankcase
Start-up	Electric
Transmission	Automatic speed variator CVT with torque server
Chassis	Unitised body made of stamped plate.
Clutch	Automatic centrifugal dry clutch

Steering and suspensions	Steering tube articulated on the front wheel carrier hub; helicoidal spring suspension and double-acting hydraulic shock absorber; rear with double-acting shock absorber and coaxial spring adjustable to 4 positions at preloading.
Front brake	Disc brake (Ø 200 mm) with hydraulic control (lever on the far right of the handlebar) and fixed calliper.
Rear brake	Ø110 mm drum brake
Front wheel rim	Die-cast aluminium alloy; 2.50 x11"
Rear wheel rim	Die-cast aluminium alloy; 3.00 x 10"
Front tyre	Tubeless; 110/70-11"
Rear tyre	Tubeless; 120/70-10"
Dry weight	110 ± 5

Kit equipment

Wrenches: box-spanner (16 mm); one twin screwdriver; one spanner for sock absorbers. The tools are located under the seat in an appropriate container.

Vespa LX 125 150 4T

Vespa®



**Chap. 05
Spare parts and
accessories**



05_01



05_02

Warnings (05_01, 05_02)

WARNING



IT IS ALSO RECOMMENDED THAT "ORIGINAL PIAGGIO SPARE PARTS" BE USED, AS THESE ARE THE ONLY ONES OFFERING YOU THE SAME QUALITY ASSURANCE AS THOSE INITIALLY FITTED ON THE VEHICLE.

IT SHOULD BE REMEMBERED THAT USING NON-ORIGINAL SPARE PARTS CAUSES YOUR WARRANTY RIGHTS TO EXPIRE.

WARNING



PIAGGIO MARKETS ITS OWN LINE OF ACCESSORIES THAT ARE RECOGNISED AND GUARANTEED FOR USE. IT IS THEREFORE ESSENTIAL, IN ORDER TO CHOOSE AND MOUNT THE ACCESSORIES CORRECTLY, TO CONTACT AN AUTHORISED DEALER OR SERVICE CENTRE. THE USE OF NON-ORIGINAL ACCESSORIES MAY AFFECT THE STABILITY AND OPERATION OF YOUR VEHICLE AND REDUCE SAFETY LEVELS WITH POTENTIAL RISKS FOR THE RIDER.

Vespa LX 125 150 4T

Vespa®



**Chap. 06
Programmed
maintenance**

Scheduled maintenance table

Adequate maintenance is fundamental to ensuring long-lasting, optimum operation and performance of your vehicle.

To this end, a series of checks and maintenance operations (at the owner's expense) have been suggested, which are included in the summary table on the following page. Any minor faults should be reported without delay to an **Authorised Service Centre or Dealer** without waiting until the next scheduled service to solve it.

All scheduled maintenance services must be carried out at the specified times, even if the stated mileage has not yet been reached. Carrying out scheduled services on time is necessary to ensure your warranty remains valid. For any further information concerning Warranty procedures and "Scheduled Maintenance", please refer to the "Warranty Booklet".

EVERY 2 YEARS

Brake fluid - change

EVERY 3000 KM

Engine oil - level check/ top-up

AFTER 1000 KM

Engine oil - replacement

Hub oil - change

Oil filter (net filter) - clean

Idle speed (*) - adjustment

Throttle lever - adjustment

Steering - adjustment

Brake control levers - greasing

Brake pads - check condition and wear

Brake fluid level - check

Safety locks - check

Electrical system and battery - check

Tyre pressure and wear - check

Vehicle and brake test - road test

(* See instructions in «Idle speed adjustment» section

AFTER 6000 KM, 18000 KM, 54000 KM

Engine oil - replacement

Hub oil level - check

Spark plug electrode gap - check

Air filter - clean

Engine oil - change

Oil filter (net filter) - clean

Valve clearance - adjustment

Variable speed rollers/pads - check

Driving belt - check

Brake pads - check condition and wear

Brake fluid level - check

Electrical system and battery - check

Centre stand - lubrication

Tyre pressure and wear - check

Vehicle and brake test - road test

AFTER 12000 KM, 60000 KM

Engine oil - replacement

Hub oil level - check

Air filter - clean

Engine oil - change

Oil filter (net filter) - clean

Spark plug - replacement

Idle speed (*) - adjustment

Throttle lever - adjustment

Pads and variator rollers - replacement

Driving belt - replacement

Odometer cable - greasing

Steering - adjustment

Brake control levers - greasing

Brake pads - check condition and wear

Brake fluid level - check

Transmission elements - lubrication

Safety locks - check

Suspensions - check

Electrical system and battery - check

Headlight - adjustment

Centre stand - lubrication

Secondary air filter - cleaning

Tyre pressure and wear - check

Vehicle and brake test - road test

() See instructions in «Idle speed adjustment» section*

AFTER 24000 KM, 48000 KM

Engine oil - replacement

Hub oil - change

Air filter - clean

Engine oil - change

Oil filter (net filter) - clean

Spark plug - replacement

Idle speed (*) - adjustment

Throttle lever - adjustment

Pads and variator rollers - replacement

Driving belt - replacement

Cylinder ventilation system - cleaning

Odometer cable - greasing

Steering - adjustment

Brake control levers - greasing

Brake pads - check condition and wear

Brake fluid level - check

Transmission elements - lubrication

Safety locks - check

Suspensions - check

Electrical system and battery - check

Headlight - adjustment

Tyre pressure and wear - check

Secondary air filter - cleaning

Centre stand - lubrication

Vehicle and brake test - road test

(*) See instructions in «Idle speed adjustment» section

AFTER 30000 KM, 42000 KM, 66000 KM

Engine oil - replacement

Hub oil level - check

Spark plug electrode gap - check

Air filter - clean

Engine oil - change

Oil filter (net filter) - clean

Slide pads and variator rollers - check

Driving belt - check

Brake pads - check condition and wear

Brake fluid level - check

Electrical system and battery - check

Centre stand - lubrication

Tyre pressure and wear - check

Vehicle and brake test - road test

AFTER 36000 KM

Engine oil - replacement

Hub oil - change

Spark plug - replacement

Air filter - clean

Engine oil - change

Oil filter (net filter) - clean

Valve clearance - adjustment

Idle speed (*) - adjustment

Throttle lever - adjustment

Pads and variator rollers - replacement

Driving belt - replacement

Odometer cable - greasing

Steering - adjustment

Brake control levers - greasing

Brake pads - check condition and wear

Brake fluid level - check

Flexible brake tubes - replacement

Transmission elements - lubrication

Safety locks - check

Suspensions - check

Electrical system and battery - check

Headlight - adjustment

Secondary air filter - cleaning

Centre stand - lubrication

Tyre pressure and wear - check

Vehicle and brake test - road test

() See instructions in «Idle speed adjustment» section*

AFTER 72,000 KM

Engine oil - replacement

Hub oil - change

Spark plug - replacement

Air filter - clean

Engine oil - change

Oil filter (net filter) - clean

Valve clearance - adjustment

Idle speed (*) - adjustment

Throttle lever - adjustment

Pads and variator rollers - replacement

Driving belt - replacement

Odometer cable - greasing

Steering - adjustment

Cylinder ventilation system - check

Brake control levers - greasing

Brake pads - check condition and wear

Brake fluid level - check

Flexible brake tubes - replacement

Transmission elements - lubrication

Safety locks - check

Suspensions - check

Electrical system and battery - check

Headlight - adjustment

Secondary air filter - cleaning

Centre stand - lubrication

Tyre pressure and wear - check

(*) See instructions in «Idle speed adjustment» section

RECOMMENDED PRODUCTS TABLE

Product	Description	Specifications
AGIP ROTRA 80W-90	Rear hub oil	SAE 80W/90 Oil that exceeds the requirements of API GL3 specifications
AGIP BRAKE 4	Brake fluid	FMVSS DOT 4 Synthetic fluid
AGIP CITY HI TEC 4T	Oil to lubricate flexible transmissions (brakes, throttle control and odometer)	Oil for 4-stroke engines
AGIP FILTER OIL	Oil for air filter sponge	Mineral oil with specific additives for increased adhesiveness
AGIP CITY HI TEC 4T	Engine oil	SAE 5W-40, API SL, ACEA A3, JASO MA Synthetic oil
AGIP GREASE MU3	Grease for odometer transmission gear case	Soap-based lithium grease with NLGI 3; ISO-L-XBCHA3, DIN K3K-20
AGIP GP 330	Grease for brake control levers, throttle, stand	White calcium complex soap-based spray grease with NLGI 2; ISO-L-XBCIB2

TABLE OF CONTENTS

A

Air filter: 36

B

Battery: 39

Brake: 38, 48, 49

C

Clock: 9

D

Disc brake: 48

E

Engine oil: 30, 31

F

Fuses: 41

H

Headlight: 44

Horn: 11

Hub oil: 32

I

Identification: 16

Immobilizer: 12, 14

K

Key switch: 10

Keys: 12

L

Light switch: 12

M

Maintenance: 29, 63, 64

Mirrors: 47

S

Saddle: 15

Scheduled maintenance: 64

Shock absorbers: 22

Spark plug: 35

Start-up: 12

T

Technical Data: 55

Top box: 16

Transmission: 26

Turn indicators: 46

Tyre pressure: 21

Tyres: 34



The descriptions and illustrations given in this publication are not binding. While the basic features as described and illustrated in this manual remain unchanged, PIAGGIO - GILERA reserves the right, at any time and without being required to update this publication beforehand, to make any changes to components, parts or accessory supplies, which it considers necessary to improve the product or which are required for manufacturing or construction reasons.

Not all versions shown in this publication are available in all Countries. The availability of individual versions should be confirmed with the official Piaggio sales network.

"© Copyright 2007 - PIAGGIO & C. S.p.A. Pontedera. All rights reserved. Reproduction of this publication in whole or in part is prohibited."

PIAGGIO & C. S.p.A. - After-Sales

V.le Rinaldo Piaggio, 23 - 56025 PONTEDERA (Pi)