

Vespa would like to thank you

for choosing one of its products. We have prepared this manual to help you to get the very best from your vehicle. Please read it carefully before riding the vehicle for the first time. It contains information, tips and precautions for using your vehicle. It also describes features, details and devices to assure you that you have made the right choice. We believe that if you follow our suggestions, you will soon get to know your new scooter and it will serve you well for a long time to come. This booklet forms an integral part of the vehicle; should the vehicle be sold, it must be transferred to the new owner.

VESPA Vespa LX 50 4T



The instructions given in this manual are intended to provide a clear, simple guide to using your vehicle; this booklet also details routine maintenance procedures and regular checks that should be carried out on the vehicle at an **authorised Dealer or Service Centre**. The booklet also contains instructions for simple repairs. Any operations not specifically described in this booklet require the use of special tools and/or particular technical knowledge: to carry out these operations, refer to any **authorised Dealer or Service Centres**.



Personal safety

Failure to completely observe these instructions will result in serious risk of personal injury.



Safeguarding the environment

Sections marked with this symbol indicate the correct use of the vehicle to prevent damaging the environment.



Vehicle intactness

The incomplete or non-observance of these regulations leads to the risk of serious damage to the vehicle and sometimes even the invalidity of the guarantee.

The signs that you see on this page are very important. They are used to highlight parts of the booklet that should be read with particular care. The different symbols are used to make each topic in the manual simple and quick to locate.

INDEX

VEHICLE	7	Sparkplugdismantlement.....	32
Dashboard.....	8	Removingtheairfilter.....	33
Clock.....	10	Secondaryairsystem.....	34
Keyswitch.....	10	Checkingthebrakeoillevel.....	35
Lockingthesteeringwheel.....	10	Battery.....	36
Releasingthesteeringwheel.....	11	Checkingtheelectrolytelevel.....	37
Switchdirectionindicators.....	11	Long periods of inactivity.....	38
Hornbutton.....	12	Fuses.....	39
Lightswitch.....	12	Frontlightgroup.....	41
Start-upbutton.....	13	Headlightadjustment.....	42
Openingthesaddle.....	13	Frontdirectionindicators.....	42
Keys.....	14	Rearopticalunit.....	43
Identification.....	14	Rearturnindicators.....	43
Rearboxopening.....	15	Rear-viewmirrors.....	44
Bagclip.....	15	Idleadjustment.....	44
USE	17	Frontdiscbrake.....	45
Checks.....	18	Reardrumbrake.....	46
Refuelling.....	18	Puncture.....	46
Tyrepressure.....	19	delveicolo.....	47
Runningin.....	20	Cleaningthevehicle.....	47
Startinguptheengine.....	20	TECHNICALDATA	53
Precautions.....	21	Toolkit.....	56
Difficultstart-up.....	22	SPAREPARTSANDACCESSORIES	57
Stoppingtheengine.....	23	Warnings.....	58
Automatictransmission.....	23	SCHEDULEDMAINTENANCE	59
Safedriving.....	24	Scheduledservicingtable.....	60
MAINTENANCE	27		
Engineoillevel.....	28		
Engineoillevelcheck.....	28		
Engineoiltop-up.....	29		
Engineoilchange.....	29		
Huboillevel.....	30		
Tyres.....	31		

VESPA Vespa LX 50 4T



**Chap. 01
Vehicle**

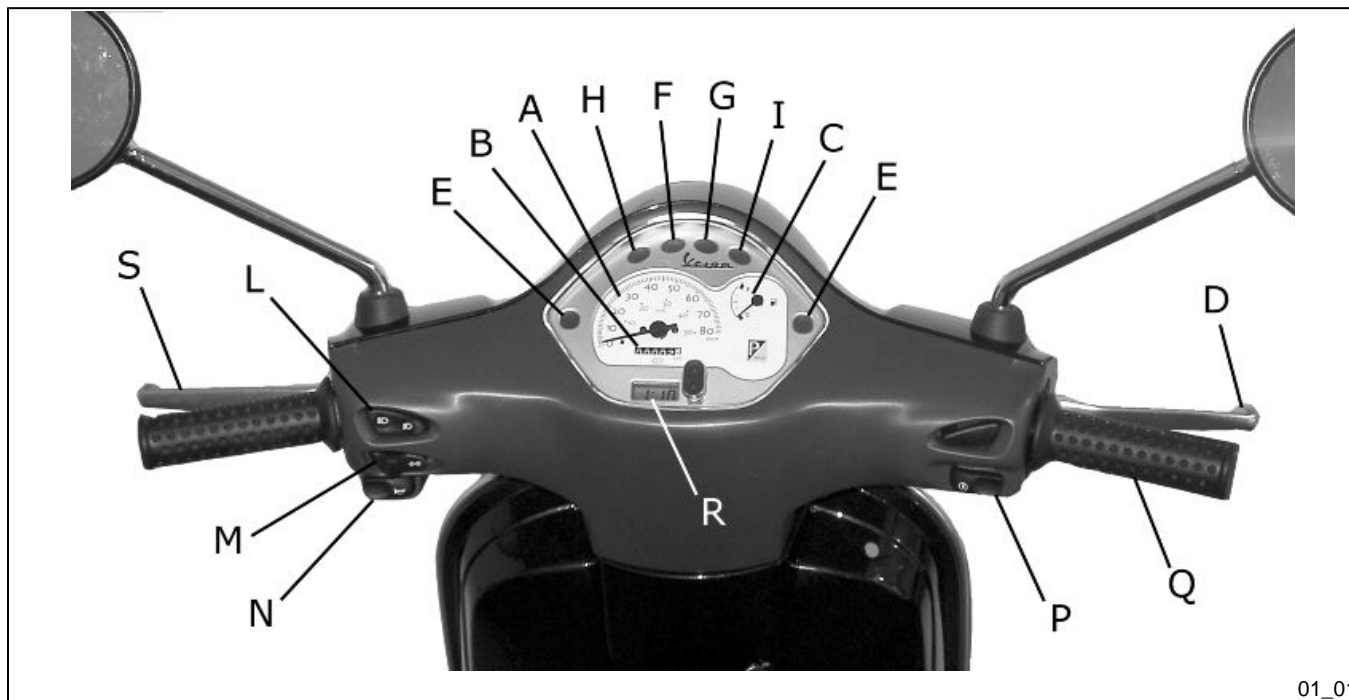

01_01

Dashboard (01_01)

A = Speedometer

B = Odometer

C = Fuel gauge

D = Front brake control lever

E = Turn indicator warning light

F = Preset light

G = High-beam warning light

H = Low fuel warning light

I = Low-beam/position light warning light

L = High/low beam switch

M = Turn indicator switch

N = Horn button

P = Starter button

Q = Throttle grip

R = Digital clock

S = Real brake control lever



Clock (01_02)

Hours and minutes are displayed in a 1 to 12, AM or PM, format on the instrument panel.

Operating the function selection switch «T» month, day and seconds can be seen besides hours and minutes. In order to adjust the above mentioned functions, operate button «U». The digital clock is powered by a battery (battery life is about 2 years); lift the whole instrument panel to replace the battery. It is advisable to take your vehicle to an **Authorised Service Centre** for this operation.

WARNING



DEAD BATTERIES ARE HARMFUL TO THE ENVIRONMENT. THEY MUST DISPOSED OF IN SUITABLE CONTAINERS AS PRESCRIBED BY THE REGULATIONS IN FORCE.



01_03

Keyswitch (01_03)

LOCK = Ignition disabled, extractable key, steering lock engaged front glove-box locked.

OFF = Ignition disabled, extractable key, steering lock disengaged, front glove-box unlocked.

ON = Ready to start position, anti-theft device disabled, non-extractable key, glove-box unlocked.

Locking the steering wheel

Turn the handlebar to the left (as far as it will go), turn the key to «**LOCK**» and remove the key.

CAUTION

DO NOT TURN THE KEY TO «LOCK» OR «KEY OFF» WHILE RIDING.

Releasing the steering wheel

Reinsert the key and turn it to «OFF».

CAUTION

DO NOT TURN THE KEY TO «LOCK» OR «KEY OFF» WHILE RIDING.

Switch direction indicators (01_04)

To set the left turn indicators flashing, move lever «B» to the left; to set the right turn indicators flashing, move it to the right. The lever automatically returns to the central position and the indicators remain on. To turn the indicators off, press the lever towards the switch.

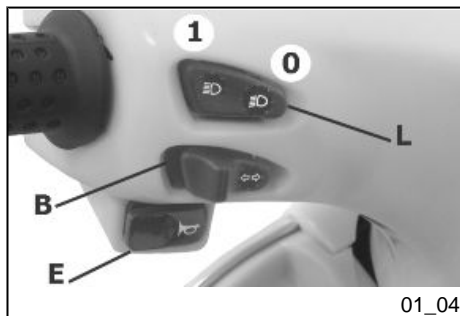

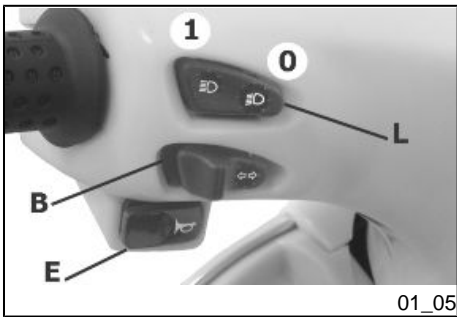

Hornbutton (01_05)

Horn button «E»

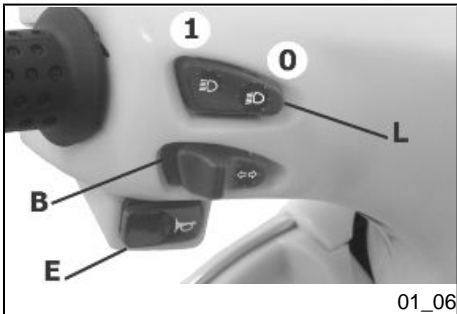

Lightswitch (01_06)

0 = Low-beam and taillight

1 = High-beam and taillight

Start-upbutton (01_07)

To start the engine, press the starter button, «P», after pulling either one of the two brake levers.

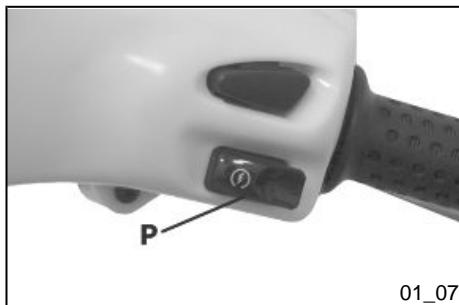

Openingthesaddle (01_08)

Insert the key into the saddle lock «A», turn it anticlockwise and tip the saddle forward.





Keys (01_09)

The vehicle is supplied with two keys (one spare) which serve to start the engine and unlock the saddle compartment. The keys are accompanied by a tag marked with the identification code to be quoted when ordering duplicates.

WARNING

WE RECOMMEND KEEPING THE DUPLICATE KEY TOGETHER WITH ITS CODE IN A SAFE PLACE AND NOT ON THE VEHICLE



Identification (01_10, 01_11)

The identification numbers consist of a prefix stamped on the chassis and on the engine, followed by a number. They must be quoted when ordering spare parts. We recommend that you check that the prefix and chassis number stamped on the vehicle correspond with those in the vehicle documents.

CAUTION



PLEASE REMIND THAT ALTERING IDENTIFICATION REGISTRATION NUMBERS CAN LEAD TO SERIOUS PENAL SANCTIONS (IMPOUNDING OF THE VEHICLE, ETC.).



Rear top box opening (01_12)

Turn the key to «OFF». Then press it. When the key is set to «LOCK», the glove-box is locked.



Bagclip (01_13)

To use the retractable bag hook «B» located at the front end of the saddle, pull it forward lightly.

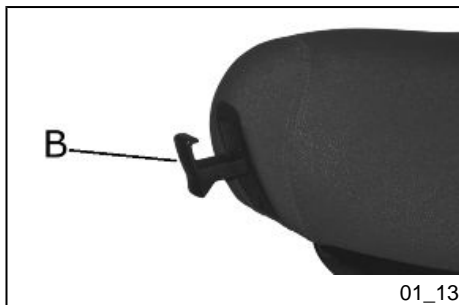

VESPA Vespa LX 50 4T



Chap. 02
Use



02_01

Checks

Before using the vehicle, check:

1. That the fuel tank is full.
2. The oil level in the rear hub.
3. Engine oil level (see section «Engine oil level»).
4. That tyres are properly inflated.
5. Correct functioning of headlights, rear taillight and turn indicators.
6. The correct functioning of the front and rear brakes.

Refuelling (02_01)

Fill fuel tank «A» with unleaded petrol (minimum octane rating = 95).

When the fuel reaches the reserve level, the warning light fitted on the instrument panel lights up.

CAUTION



SHUT OFF THE ENGINE BEFORE REFUELLING WITH PETROL. PETROL IS HIGHLY FLAMMABLE. DO NOT LET PETROL SPILL FROM THE TANK OR WHILE REFUELLING

CAUTION



DO NOT BRING NAKED FLAMES OR CIGARETTES NEAR THE MOUTH OF THE FUEL TANK: FIRE HAZARD. ALSO AVOID INHALING HARMFUL VAPOURS.

CAUTION

USING OILS OTHER THAN THOSE RECOMMENDED CAN SHORTEN THE LIFE OF THE ENGINE.

Characteristic**Fuel tank capacity**

~ 8.5 l (2 l of which is reserve)

Tyrepressure**CAUTION**

TYRE PRESSURE SHOULD BE CHECKED WHEN TYRES ARE COLD. INCORRECT TYRE PRESSURE CAUSES ABNORMAL TYRE WEAR AND MAKES RIDING DANGEROUS.

TYRES MUST BE REPLACED WHEN THE TREAD REACHES THE WEAR LIMITS SET FORTH BY LAW.

Characteristic**Front tyre pressure**

1.6 bar

Rear tyre pressure

2 bar



Runningin (02_02)

WARNING



DURING THE FIRST 1000 KM DO NOT RIDE THE VEHICLE OVER 80% OF ITS MAXIMUM SPEED. AVOID TWISTING THE THROTTLE GRIP FULLY OR KEEPING A CONSTANT SPEED ALONG LONG SECTIONS OF ROAD. AFTER THE FIRST 1000 KM, GRADUALLY INCREASE SPEED UNTIL REACHING THE MAXIMUM PERFORMANCE.

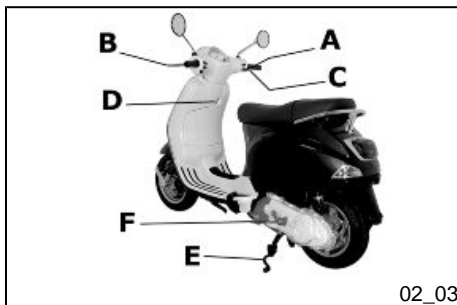

Startinguptheengine (02_03)

The vehicle is fitted with direct drive automatic transmission. Therefore, always start the engine with the throttle grip slightly twisted; to start-off from stationary position, progressively twist the throttle grip.

The vehicle is equipped with a fuel valve and a starter which switch on automatically as soon as the engine is started.

To start it up, it is necessary to:

- 1: Put the scooter on its stand "E"; check that the rear wheel is off the ground.
- 2: Keep the throttle grip slightly twisted.
- 3: Insert the key in ignition switch «D» and turn it to «ON»; when turning the key to «ON», the fuel reserve warning light turns on for a few seconds indicating the correct functioning of the bulb.
- 4: Push the starter button «A» after pulling the rear brake lever «B» or the front brake lever «C».

CAUTION

DO NOT CARRY OUT THESE OPERATIONS IN CLOSED AREAS SINCE EXHAUST GASES ARE TOXIC.

CAUTION

ALWAYS PLACE THE VEHICLE ON ITS STAND BEFORE KICK STARTING.

Precautions**CAUTION**

NEVER STRESS THE ENGINE AT LOW TEMPERATURES IN ORDER TO AVOID POSSIBLE DAMAGE. BE CAREFUL NEVER TO EXCEED THE MAXIMUM SPEED WHILE RUNNING DOWNHILL, IN ORDER TO AVOID DAMAGING THE ENGINE. IN ANY CASE, IN ORDER TO PRESERVE THE ENGINE FROM PROLONGED OVERREVVING, THE REVOLUTION LIMITER WILL BE ACTIVATED IF THE ENGINE SPEED EXCEEDS THE ESTABLISHED THRESHOLD.

WARNING

AFTER A LONG DISTANCE COVERED AT THE MAXIMUM SPEED, DO NOT STOP THE ENGINE IMMEDIATELY, BUT LET IT RUN AT IDLE FOR A FEW SECONDS.

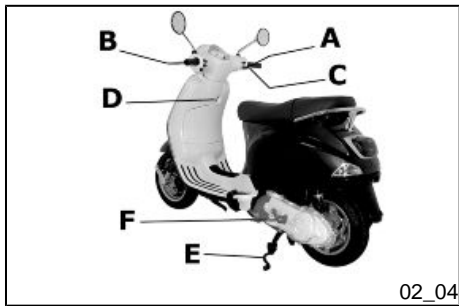

Difficultstartup (02_04)

If there is a problem you can follow the instructions below:

1. Engine flooded. Place the vehicle on its centre stand and check that the rear wheel is off the ground. Open the throttle fully and press the starter button for five seconds and then stop for five seconds. If the engine does not start after a few attempts, let the engine sit for a few minutes and then repeat the above operations. In any case do not operate the starter motor longer than 20" in an attempt to start the engine.

2. Battery or starter motor inefficiency. Put the scooter on its stand "E"; make sure that the rear wheel is off the ground, turn the key switch «D» to «ON» and use the kick-starter «F».

3. Empty fuel tank. After refuelling the scooter, start the engine by pressing the starter button «A» with the throttle at a minimum to provide maximum aspiration for the tap. If the vehicle fails to start even after carrying out the steps described above, contact an **Authorised Service Centre**.

CAUTION



ALWAYS PLACE THE VEHICLE ON ITS STAND BEFORE KICK STARTING.

WARNING



TAMPERING MAY CAUSE SERIOUS ENGINE MALFUNCTION.

Stopping the engine (02_05)

Stop acceleration, then turn the key switch «D» to «OFF» to stop the engine (extractable key).

CAUTION



DUE TO THE HIGH TEMPERATURES THE CATALYTIC CONVERTER CAN REACH, ALWAYS TAKE CARE, WHEN PARKING THE VEHICLE, THAT THE EXHAUST DOES NOT COME INTO CONTACT WITH FLAMMABLE MATERIALS, TO AVOID SERIOUS BURNS.

Automatic transmission

To ensure simple, pleasurable riding, the vehicle is equipped with automatic transmission with regulator and centrifugal clutch. The system is designed to give the best possible performance in terms of both acceleration and consumption, on level ground and uphill, thanks to the adjustments made to engine speed and transmitted torque. If you have to stop on an uphill slope (traffic lights, traffic jam, etc.) only use the brake to keep the vehicle still, leaving the motor running at idling speed. Using the motor to keep the vehicle still can cause the clutch to overheat. This problem is due to the friction of the clutch parts on the clutch bell. It is therefore recommended to avoid conditions of prolonged clutch slippage leading to clutch overheating (for example, as well as the situation described above, riding uphill fully laden on steep slopes or starting off on slopes greater than 25%, etc.):

1. Do not continue riding in such conditions.
2. Let the clutch cool down with the motor at idling speed for a few minutes

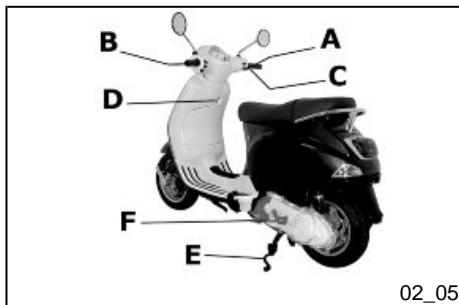

02_05

Safedriving

WARNING



SOME SIMPLE TIPS ARE PROVIDED BELOW WHICH WILL ENABLE YOU TO USE YOUR VEHICLE ON A DAILY BASIS MORE EASILY AND SAFELY.

<

Your ability and your knowledge of the vehicle form the basis of safe riding. We recommend trying out the vehicle in traffic-free zones to get to know your vehicle completely.

ALWAYS DRIVE WITHIN YOUR LIMITS

1. Before riding off, remember to put on your helmet and fasten it correctly.
2. Reduce speed and ride cautiously on uneven roads.
3. Remember that after riding on a long stretch of wet road without using the brakes, the braking effect is initially lower. Under these conditions, it is a good idea to operate the brakes from time to time.
4. Do not brake hard on a wet surface, on dirt tracks or on any slippery road surface.
5. If you have to brake, use both brakes in order to divide the braking action between both wheels.
6. Avoid starting off by mounting the vehicle while it is still resting on its stand. In any case, the rear wheel should not be turning when it comes into contact with the ground, in order to avoid abrupt departures.
7. If the vehicle is used on roads covered with sand, mud, snow mixed with salt, etc., clean the brake disc frequently with mild detergent in order to prevent abrasive substances from building up within the holes, which can result in early wear of the brake pads.

8. Any elaboration that modifies the vehicle's performances, such as tampering with original structural parts is strictly forbidden by law, and renders the vehicle not conforming to the approved type and therefor dangerous to ride.

CAUTION

RIDING UNDER THE INFLUENCE OF ALCOHOL, DRUGS OR CERTAIN MEDICINES CAN BE EXTREMELY DANGEROUS FOR ONESELF AND FOR OTHERS.

CAUTION

ANY ELABORATION THAT MODIFIES THE VEHICLE'S PERFORMANCES, SUCH AS TAMPERING WITH ORIGINAL STRUCTURAL PARTS IS STRICTLY FORBIDDEN BY LAW, AND RENDERS THE VEHICLE NO LONGER CONFORMING TO THE APPROVED TYPE AND DANGEROUS FOR RIDING.

VESPA Vespa LX 50 4T



Chap. 03
Maintenance

Engineoillevel

In 4T engines, the engine oil is used to lubricate the distribution elements, the bench bearings and the thermal group. **An insufficient quantity of oil can seriously damage the engine.** In all 4T engines the decay of oil characteristics as well as some consumption is normal. Consumption can particularly reflect the conditions of use (i.e. when driving at 'full acceleration' all the time, oil consumption increases).

In order to avoid problems, it is advisable to control oil level every time the vehicle is used.

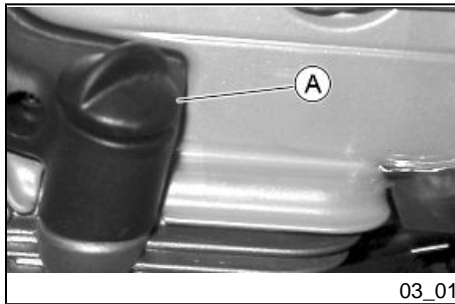

03_01

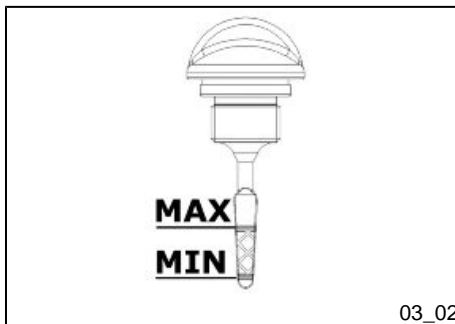

03_02

Engineoillevelcheck (03_01, 03_02)

Check oil level every time the vehicle is used, with the engine cold. The level should be between the MAX and MIN marks on the oil level dipstick «A » shown in the figure; the stand should be firm on an even surface during the check.

If the check is carried out after the vehicle has been used, and therefore with a hot engine, the level line will be lower; in order to carry out a correct check, wait at least 10 minutes after the engine has been stopped so as to get the correct level.

Check by pushing the dipstick all the way into the hole.

CAUTION



RUNNING THE ENGINE WITH INSUFFICIENT LUBRICATION OR WITH THE INADEQUATE LUBRICANTS ACCELERATES WEAR AND TEAR OF THE MOVING PARTS AND CAN CAUSE IRRETRIEVABLE DAMAGE.

Characteristic

Engine oil

Capacity: ~ 850 cm³

Engineoiltop-up

Always check oil level before carrying out top-ups and add oil **without exceeding the MAX level**. An engine oil check-up and top-up should be carried out every 3,000 km at an **Authorised Piaggio Service Centre**.

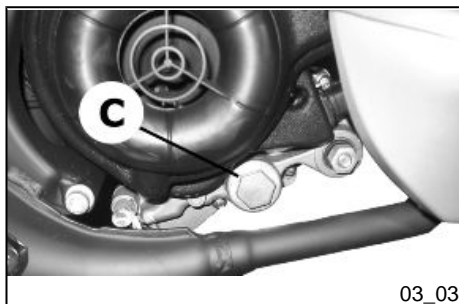

Engineoilchange (03_03)

Change oil and clean the filter after every 6,000 km at an **Authorised Service Centre**. Empty the engine by draining the oil through drainage cap «C» with a cold engine. First unscrew the cap-dipstick used to check engine oil level, then cap «C» and take out the mesh filter. After cleaning and mounting again the mesh filter, screw cap «C» and fill with oil the hole of the cap-dipstick used to check engine oil level. Then start the vehicle, leave it running for a few minutes and switch it off: 5 minutes later check oil level and, if necessary, add oil **without exceeding the MAX level**. Only use new oil of the recommend type for oil top-ups and change.

CAUTION



USED OILS CONTAIN SUBSTANCES HARMFUL TO THE ENVIRONMENT. FOR OIL CHANGE, CONTACT AN AUTHORISED SERVICE CENTRE WHICH IS EQUIPPED TO DISPOSE OF USED OILS IN AN ENVIRONMENTALLY FRIENDLY AND LEGAL WAY.

Recommended products

eni i-Ride PG 5W-40

Synthetic based lubricant for high-performance four-stroke engines.
JASO MA, MA2 - API SL - ACEA A3



03_04

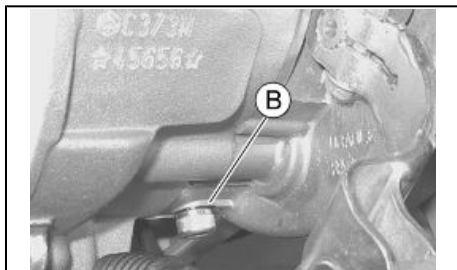

03_05

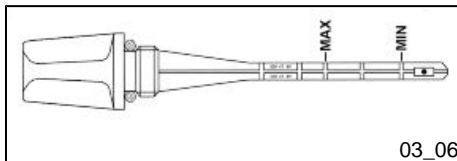

03_06

Huboillevel (03_04, 03_05, 03_06)

To check the hub oil level, proceed as follows:

1. Park the scooter on level ground and rest it on its stand.
2. Unscrew the oil dipstick «A», dry it with a clean cloth and then reinsert it, **screwing it fully into place**;
3. Unscrew the dipstick again and check that the oil level just reaches the **2nd notch from the bottom**;
4. Screw the dipstick back into place completely.

The screw «B» is the hub oil drainage plug.

CAUTION



RUNNING THE ENGINE WITH INSUFFICIENT LUBRICATION OR WITH THE INADEQUATE LUBRICANTS ACCELERATES WEAR AND TEAR OF THE MOVING PARTS AND CAN CAUSE IRRETRIEVABLE DAMAGE.

CAUTION



USED OILS CONTAIN SUBSTANCES HARMFUL TO THE ENVIRONMENT. FOR OIL REPLACEMENT, CONTACT AN AUTHORISED SERVICE CENTRE WHICH IS EQUIPPED TO DISPOSE OF USED OILS IN AN ENVIRONMENTALLY FRIENDLY AND LEGAL WAY.

N.B.

THE NOTCHES ON THE HUB OIL LEVEL DIPSTICK, EXCEPT THE ONE INDICATING THE MAXIMUM AND MINIMUM LEVEL, REFER TO OTHER MODELS BY THE MANUFACTURER AND HAVE NO SPECIFIC FUNCTION FOR THIS MODEL.

Recommended products

AGIP GEAR SAE 80W-90

Lubricant for gearboxes and transmissions.

API GL-4

Characteristic

Rear hub oil

Quantity: approx. 85 cc

Tyres (03_07)

Periodically check the inflation pressure of each tyre (when cold). The tyres are fitted with a wear indicator and must be replaced as soon as such indicator appears on the tread. Also ensure that the tyres do not show cuts on the walls or an irregular wear of the tread; if this is the case, please contact an authorised or adequately equipped workshop.

CAUTION



TYRE PRESSURE SHOULD BE CHECKED WHEN TYRES ARE COLD. INCORRECT TYRE PRESSURE CAUSES ABNORMAL TYRE WEAR AND MAKES RIDING DANGEROUS.

TYRES MUST BE REPLACED WHEN THE TREAD REACHES THE WEAR LIMITS SET FORTH BY LAW.

Characteristic

Front tyre pressure

1.6 bar

Rear tyre pressure

2 bar

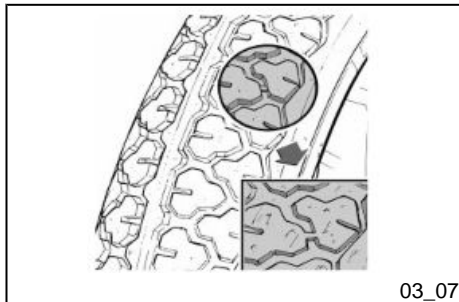

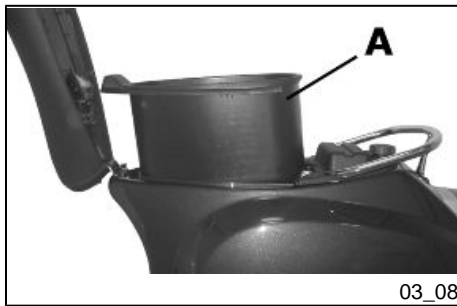

03_08

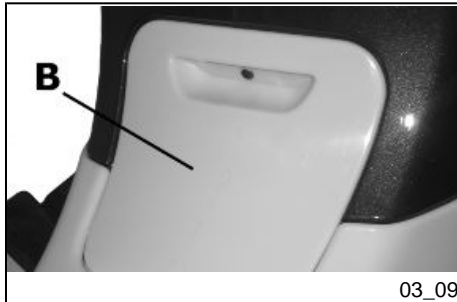

03_09

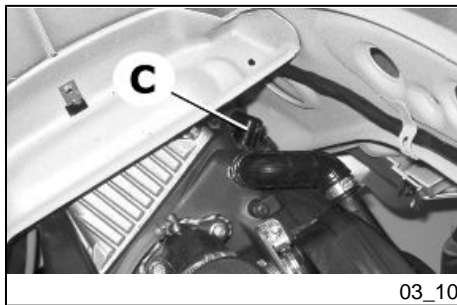

03_10

Sparkplugdismantlement (03_08, 03_09, 03_10, 03_11)

The engine must be cold to inspect the sparkplug, proceed as follows:

1. Lift the saddle and remove the helmet compartment "A";
2. Remove the sparkplug inspection door "B";
3. Remove plug cap "C";
4. Use the equipped spanner "D"(with rubber stop) and a 13 mm spanner to remove the sparkplug.

To reassemble repeat the procedure in the opposite order using the spanner to insert the sparkplug and to tighten it in its seat, making sure to install it and screw it down at the correct angle.

The above operations need to be carried out very carefully by inserting the left hand from the sparkplug inspection door and the right hand from the helmet compartment. To reassemble the door carry out the operations in the opposite order, making sure to insert the tab in the part of the central covering.

WARNING



THE SPARK PLUG MUST BE REMOVED WHEN THE ENGINE IS COLD. THE USE OF A SPARK PLUG WITH THERMAL GRADE OR THREAD OTHER THAN THE INDICATED TYPE (SEE «DATA» SECTION) CAN SERIOUSLY DAMAGE THE ENGINE. REPLACE SPARK PLUGS AT THE INTERVALS INDICATED IN THE SCHEDULED MAINTENANCE TABLE.

N.B.

USE OF SPARK PLUGS OTHER THAN THE INDICATED TYPE OR UNSHIELDED SPARK PLUG CAPS CAN LEAD TO FAULTS IN THE VEHICLE 'S ELECTRICAL SYSTEM.

Characteristic

Spark plug

NGK CR 8EB



Alternative spark plug

DENSO U24ESR-NB

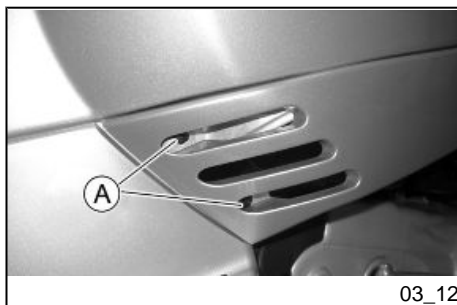

Removing the air filter (03_12, 03_13)

Remove the side fairing unscrewing the 2 screws **A**. Take off air cleaner cover «**D**» after having unscrewed the 6 fixing screws «**C**», then take out the filter. Clean with water and car shampoo, afterwards dry with compressed air and submerge in a recommended oil and petrol mixture in ratio of 50%. Afterwards squeeze it, leave it to dry and mount it again.

CAUTION



IN CASE OF RIDING ON DUSTY ROADS IT IS ADVISABLE TO CLEAN THE AIR FILTER MORE FREQUENTLY THAN INDICATED IN THE RELEVANT CHAPTER ON SCHEDULED MAINTENANCE.

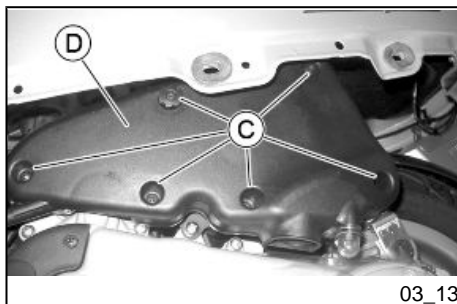

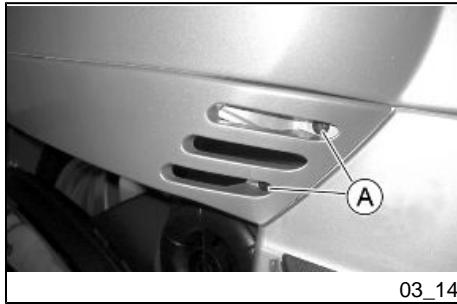

Secondaryairsystem (03_14, 03_15, 03_16, 03_17)

Undo the two screws «A» of the side fairing and remove the fairing. Undo the three screws «B» and remove the housing cover of the secondary air system. Detach the housing cover and remove the filtering element «C» made of sponge. Wash the sponge with water and neutral soap, then dry with a clean cloth and short blasts of compressed air. While cleaning the filter, check the condition of the reed valve «D», and fit it back in place on the housing.

Before closing the cover of the SAS housing, check the good condition of the sealing O-ring; replace it if damaged or deformed.

N.B.

The reed valve can be inserted in only one direction on the SAS housing

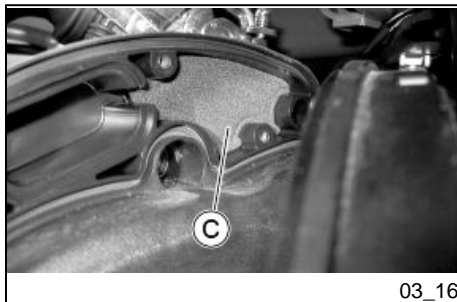
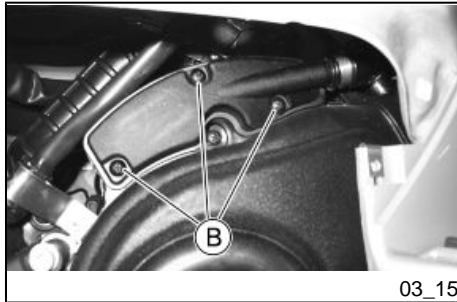

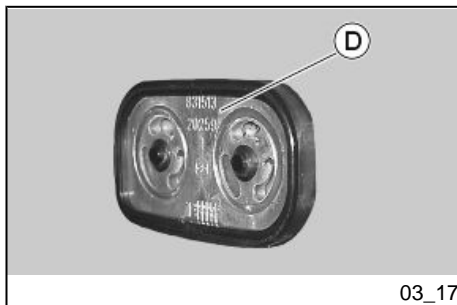

03_17

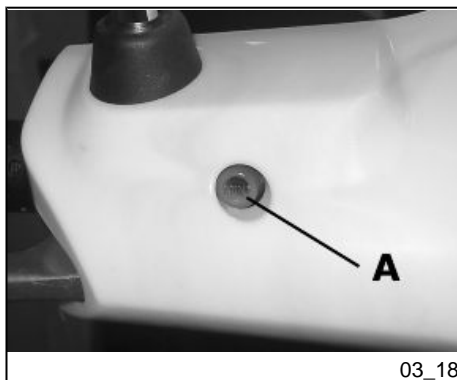

03_18

Checking the brake oil level (03_18, 03_19)

The brake fluid reservoir is equipped with a sight glass «A» made of transparent material; the quantity of liquid contained in the sight glass indicates the level of liquid in the reservoir.

When the sight glass «A» is full, the level inside the reservoir exceeds the MIN level; when it is partially full, the level drops to the MIN level; when it is fully empty, the level of fluid in the reservoir is below the MIN level.

The brake fluid level may fall due to wear on the brake pads. In case the pad wear is below the minimum mark, contact an **Authorised Service Centre** to have the braking system thoroughly checked. If you need to top up the level, follow the steps listed below. Unscrew the 2 screws «B», remove the reservoir cap «C» and pour in the required quantity of fluid (the brake fluid level must be above minimum). Place the handlebar in the riding position and pay attention not to tilt the vehicle in order to keep the brake fluid reservoir in horizontal position when checking the fluid level.

CAUTION

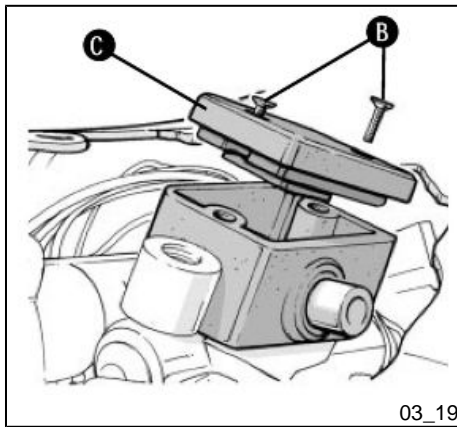

TOP-UPS SHOULD ONLY BE CARRIED OUT WITH DOT4 CLASSIFIED BRAKE FLUID.

**WARNING**

IN NORMAL CLIMATIC CONDITIONS IT IS ADVISABLE TO REPLACE THE ABOVE-MENTIONED FLUID EVERY 2 YEAR. NEVER USE BRAKE FLUID CONTAINED IN CONTAINERS WHICH ARE ALREADY OPEN OR PARTIALLY USED.

CAUTION

THE BRAKING CIRCUIT FLUID IS HIGHLY CORROSIVE. THEREFORE, WHEN TOPPING UP, AVOID LETTING IT COME INTO CONTACT WITH THE PAINTED PARTS OF THE VEHICLE. THE BRAKING CIRCUIT FLUID IS HYGROSCOPIC, THAT IS, IT ABSORBS HUMIDITY FROM THE SURROUNDING AIR. IF MOISTURE CONTAINED IN THE BRAKE FLUID EXCEEDS A CERTAIN VALUE, THIS WILL RESULT IN INEFFICIENT BRAKING.

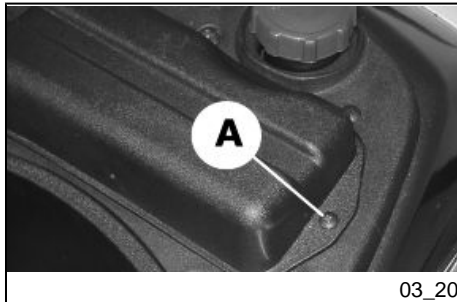
**Battery (03_20)**

To access the battery, tilt the saddle forwards, then remove the battery compartment access door by unscrewing the star-shaped screw "A" shown in the figure.

The battery is the electrical device that requires the most frequent attention and the most thorough maintenance.

WARNING

USED BATTERIES ARE HARMFUL FOR THE ENVIRONMENT. COLLECTION AND DISPOSAL SHOULD BE CARRIED OUT IN COMPLIANCE WITH REGULATIONS IN FORCE.

CAUTION

ELECTROLYTE CONTAINS SULPHURIC ACID: AVOID CONTACT WITH EYES, SKIN AND CLOTHES. IN CASE OF ACCIDENTAL CONTACT, RINSE WITH ABUNDANT WATER AND CONSULT A DOCTOR.

CAUTION

IN ORDER TO AVOID DAMAGING THE ELECTRICAL SYSTEM, NEVER DISCONNECT THE WIRING WHILE THE ENGINE IS RUNNING. DO NOT TIP THE VEHICLE TOO MUCH IN ORDER TO AVOID DANGEROUS LEAKAGE OF THE BATTERY ELECTROLYTE.

Checkingtheelectrolytelevel

The electrolyte level, which should be checked regularly, must always be at the maximum level. To reach this level, use only distilled water. Should it become necessary to top up the battery with water too frequently, check the vehicle's electrical system because the battery is being overloaded, causing it to lose power quickly.

CAUTION

ELECTROLYTE CONTAINS SULPHURIC ACID: AVOID CONTACT WITH EYES, SKIN AND CLOTHES. IN CASE OF ACCIDENTAL CONTACT, RINSE WITH ABUNDANT WATER AND CONSULT A DOCTOR.

Long periods of inactivity

Battery performance will be poor if the vehicle is not used for a long time. This is the result of the natural phenomenon of battery discharging, and may be due to residual absorption by vehicle components with constant power consumption. Poor battery performance may also be due to environmental conditions and the cleanliness of the poles. In order to avoid difficult starts and/or irreversible damage to the battery, follow any of these steps:

- **At least once a month** start the engine and run it slightly above idle speed for 10-15 minutes. This keeps all the engine components, as well as the battery, in good working order.

- Take your vehicle to a garage (as indicated in the «Vehicle not used for extended periods» section) to have the battery removed. Have the battery cleaned, charged fully and stored in a dry, ventilated place. Recharge **at least once every two months**.

N.B.

THE BATTERY MUST BE CHARGED WITH A CURRENT EQUAL TO 1/10 OF THE RATED CAPACITY OF THE BATTERY AND FOR NOT LONGER THAN 10 HOURS. CONTACT AN AUTHORISED SERVICE CENTRE TO CARRY OUT THIS OPERATION SAFELY. WHEN REFITTING THE BATTERY MAKE SURE THE LEADS ARE CORRECTLY CONNECTED TO THE TERMINALS.

WARNING



DO NOT DISCONNECT THE BATTERY CABLES WITH THE ENGINE RUNNING, THIS CAN CAUSE IRREPARABLE DAMAGE TO THE VEHICLE'S ELECTRONIC CONTROL UNIT.

WARNING

USED BATTERIES ARE HARMFUL FOR THE ENVIRONMENT. COLLECTION AND DISPOSAL SHOULD BE CARRIED OUT IN COMPLIANCE WITH REGULATIONS IN FORCE.

Fuses (03_21)

The electrical system is protected by a 10A fuse valve «**B**» located next to the battery. Before replacing a blown fuse, find and solve the problem that caused it to blow. Do not replace the fuse with any alternative form of conductor

CAUTION

IN ORDER TO AVOID DAMAGING THE ELECTRICAL SYSTEM, NEVER DISCONNECT THE WIRING WHILE THE ENGINE IS RUNNING. DO NOT TIP THE VEHICLE TOO MUCH IN ORDER TO AVOID DANGEROUS LEAKAGE OF THE BATTERY ELECTROLYTE.

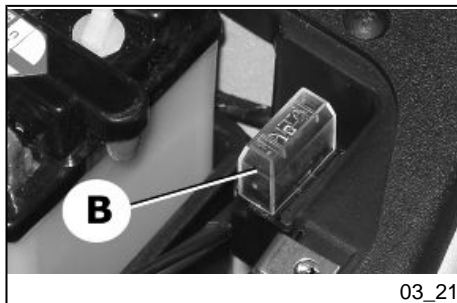
**BULB**

High/low beam light bulb

Type: Spherical

Power: 12V 35/35W

	Quantity: 1
Front side light bulb	Type: All glass Power: 12V 5W Quantity: 1
Instrument panel lighting bulbs	Type: All glass Power: 12V 1.2W Quantity: 3
Front turn indicator light bulb	Type: Spherical Power: 12V - 10W Quantity: 1 RHS + 1 LHS
Rear turn indicator light bulb	Type: Spherical Power: 12V - 10W Quantity: 1 RHS + 1 LHS
Stop and tail light bulb	Type: Spherical Power: 12V 21/5W Quantity: 1
12V - 2W warning light bulbs	Type: All glass Function: Turn indicators Quantity: 2
12V - 1.2W warning light bulb	Type: All glass

Function: Lights, high-beam lights, fuel reserve

Quantity: 3



03_22

Frontlightgroup (03_22, 03_23)

To access the headlight bulbs, remove the front of the handlebar cover, as follows:

- 1) Remove the rear-view mirrors; for this operation follow the instructions described and illustrated in the «Rear-view mirrors» section.
- 2) Unscrew the 3 screws holding the handlebar cover. The front central one «B» and the rear 2 «C». Once this is done, the handlebar cover can be removed.
- 3) Remove the handlebar cover to access the headlight and the bulbs.

N.B.

IF MISTING IS NOTICED ON THE INSIDE OF THE HEADLAMP GLASS, THIS DOES NOT INDICATE A FAULT AND IS ATTRIBUTABLE TO HUMIDITY AND/OR TO LOW TEMPERATURES.

THE PHENOMENON SHOULD QUICKLY DISAPPEAR WHEN THE LIGHT IS SWITCHED ON.

THE PRESENCE OF DROPS OF WATER, ON THE OTHER HAND, COULD INDICATE THAT WATER IS INFILTRATING. CONTACT THE AFTER-SALES SERVICE NETWORK.

Electric characteristic

Bulbs

1 12V35/35W bulb for high- and low-beam light

1 12V-5W bulb for side light

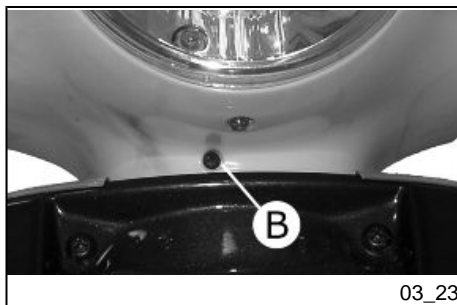

03_23

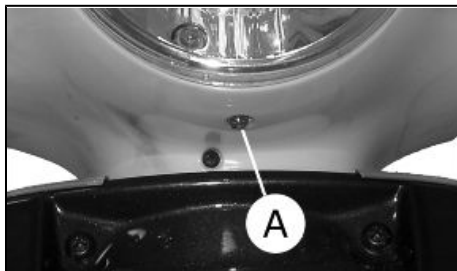

03_24

Headlightadjustment (03_24, 03_25)

Proceed as follows:

1. Place the vehicle in running order and with the tyres inflated to the prescribed pressure, on a flat surface 10 m away from a white screen situated in a shaded area, making sure that the longitudinal axis of the vehicle is perpendicular to the screen;
2. Turn on the headlight and check that the borderline of the projected light beam on the screen is no higher than 9/10 or lower than 7/10 of the distance from the ground to the centre of the vehicle's headlamp;
3. If otherwise, adjust the right headlight with screw «A».

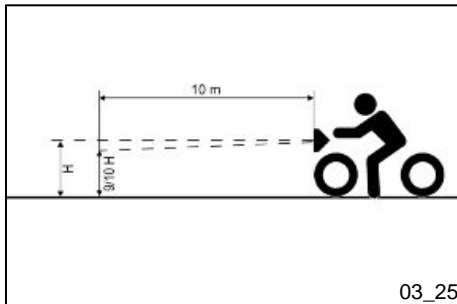

03_25

N.B.

THE ABOVE PROCEDURE COMPLIES WITH THE EUROPEAN STANDARDS REGARDING MAXIMUM AND MINIMUM HEIGHT OF LIGHT BEAMS. REFER TO THE STATUTORY REGULATIONS IN FORCE IN EVERY COUNTRY WHERE THE VEHICLE IS USED.

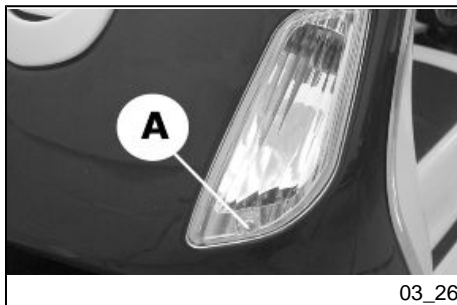

03_26

Frontdirectionindicators (03_26)

To replace the front turn indicator bulbs, remove the tail light taking out the retaining screw "A", remove the bulb holder from its fitting; gently turn the bulb around 30° and remove it. Follow the process in reverse order to refit.

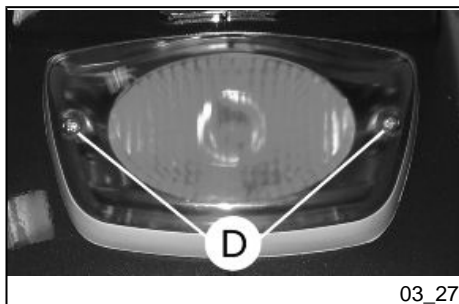

Rearopticalunit (03_27)

In order to reach the rear light bulb, remove the 2 «D» retaining screws. Gently push and turn the bulb about 30° and then remove it. To refit follow the same steps but in reverse order.

N.B.

IF MISTING IS NOTICED ON THE INSIDE OF THE HEADLAMP GLASS, THIS DOES NOT INDICATE A FAULT AND IS ATTRIBUTABLE TO HUMIDITY AND/OR TO LOW TEMPERATURES.

THE PHENOMENON SHOULD QUICKLY DISAPPEAR WHEN THE LIGHT IS SWITCHED ON.

THE PRESENCE OF DROPS OF WATER, ON THE OTHER HAND, COULD INDICATE THAT WATER IS INFILTRATING. CONTACT THE AFTER-SALES SERVICE NETWORK.



Rearturnindicators (03_28)

To gain access to the turn indicator bulbs, remove the fastening screws «E».

The bulbs have a bayonet coupling, to remove them press gently and twist anticlockwise about 30°. To refit follow the same steps but in reverse order.

Rear-viewmirrors (03_29)

The mirrors can be set to the desired position by adjusting the mirror frame.

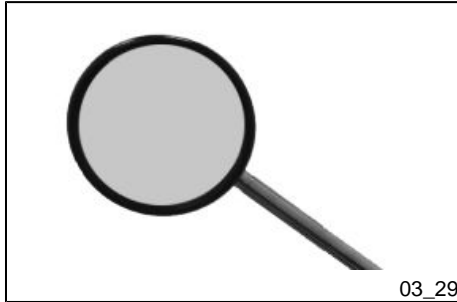

To remove the rear-view mirror rotate the rear-view mirror support rod clockwise.

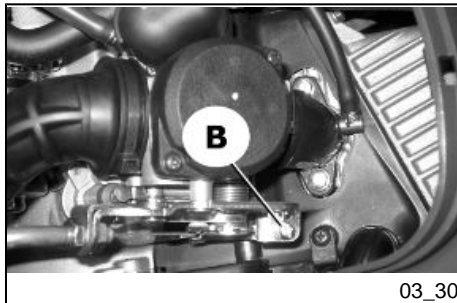

Idleadjustment (03_30)

Proceed as follows:

1. Rest the scooter on its centre stand and lift the saddle (as described in the «Saddle opening to reach helmet compartment» section).
2. Remove the helmet compartment.
3. To adjust the idle speed, start the engine, then loose or tighten the screw «B» until you reach the recommended idle speed taking care the engine does not make the rear wheel move.

If adjustment is difficult, take your vehicle to a **Dealer or an Authorised PIAGGIO Service Centre** to adjust **CO** to idle speed.

WARNING



IDLE SPEED MUST BE ADJUSTED WHEN THE ENGINE IS VERY HOT. BEFORE THIS OPERATION, MAKE SURE THAT THE THROTTLE GRIP HAS THE RECOMMENDED BACKLASH. IF CLEARANCE IN THE THROTTLE CONTROL TRANS-

MISSION NEEDS ADJUSTING TAKE YOUR SCOOTER TO AN AUTHORISED DEALER OR SERVICE CENTRE.

Characteristic

Engine idle speed

1,700 ± 100 rpm

Frontdiscbrake (03_31)

The brake disc and pad wear is automatically compensated, therefore it has no effect on the functioning of the front and rear brakes. For this reason it is not necessary to adjust the brakes. An excessively elastic brake lever stroke may indicate the presence of air in the braking circuit or an irregular brake operation. In this case, particularly considering the importance of the brakes in terms of safety, it is strongly recommended that you take the vehicle to an **Authorised Service Centre** as soon as possible for the appropriate checks.

WARNING



CHECK BRAKE PADS FOR WEAR ON A REGULAR BASIS (AS INDICATED IN THE SCHEDULE MAINTENANCE TABLES). IF THE THICKNESS OF ONE OR BOTH PADS IS IN THE REGION OF 1.5 MM, BOTH PADS MUST BE CHANGED. IT IS RECOMMENDED TO CARRY OUT THIS OPERATION AT AN AUTHORISED SERVICE CENTRE AS SOON AS POSSIBLE.

AFTER FITTING NEW BRAKE PADS DO NOT USE THE VEHICLE UNTIL YOU HAVE ACTIVATED THE BRAKE LEVER REPEATEDLY TO POSITION THE PADS AND RESTORE THE LEVER STROKE TO ITS CORRECT POSITION.

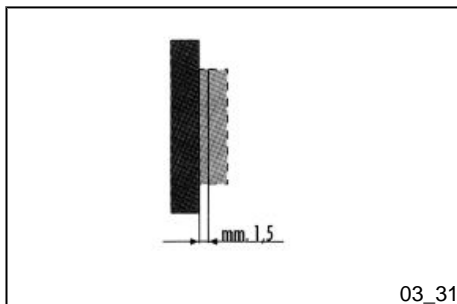

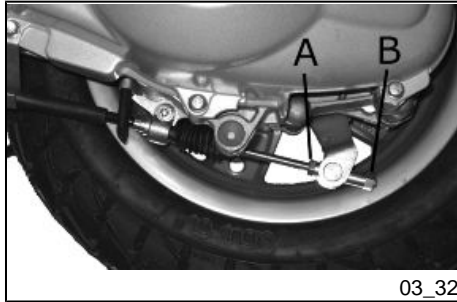
**CAUTION**

BRAKING SHOULD BEGIN AFTER ABOUT 1/3 OF THE BRAKE LEVER STROKE.

Rear drumbrake (03_32)

Operate adjusting nut «**B**» and loosen lock nut «**A**» shown in the figure. Note that when the throttle is in idle **the wheel should rotate free**. After the adjustment, screw lock nut «**A**».

CAUTION

BRAKING SHOULD BEGIN AFTER ABOUT 1/3 OF THE BRAKE LEVER STROKE.

Puncture (03_33)

The vehicle is equipped with Tubeless tyres. When there is a puncture, Tubeless tyres - unlike tyres with inner tubes - go flat very slowly. This offers greater riding safety. A tyre that goes flat very slowly can be repaired with an "Inflate and Repair" spray. Tyres should be later fully repaired or replaced at an **Authorised Service Centre**.



03_34

delveicolo (03_34)

We recommend carrying out the following operations:

- 1 - General cleaning of the vehicle.
- 2 - With the engine off and the piston at bottom dead centre position, remove the spark plug and pour 1÷2 cc of motor oil through its hole. Operate the starter motor 3-4 times letting the engine perform a few revolutions, then remount the spark plug.
- 3 - Drain up all the vehicle's fuel; spread antirust grease on the uncoated metal parts; keep the wheels lifted above the ground.
- 4 - For the battery, follow the procedures described in the «Battery» section.
- 5 - Drain the petrol from the carburettor tank.
- 6 - Replace engine oil.

Recommended products

eni i-Ride PG 5W-40

*Synthetic based lubricant for high-performance four-stroke engines.
JASO MA, MA2 - API SL - ACEA A3*

Cleaningthevehicle

Use a low pressure jet of water to soften the caked dirt and mud deposited on the painted surfaces. Once softened, sponge off mud and dirt using a car body sponge soaked in a car body shampoo and water solution (2-4% of car shampoo in water). Then rinse with abundant water, and dry with a shammy cloth. For the engine exterior, use petrol, a brush and clean cloths. Petrol can damage paintwork. Remember that any polishing with silicone wax must always be preceded by washing.

WARNING

To avoid the appearance of oxidations, wash the vehicle every time it is used in certain areas or in special conditions of:

- Environmental / seasonal conditions: use of salt, de-icer chemical products on the road in winter.
- Air pollution: city and/or industrial areas.
- Salinity and humidity of the atmosphere: marine areas, hot and wet weather.

WARNING

- Prevent deposits from remaining on the bodywork, industrial and pollutant residual dust, tar spots, dead insects, bird droppings, etc.
- Do not park the vehicle under the trees. In some seasons, in fact, residues, resins, fruits or leaves may fall from the trees, containing chemicals that are harmful to the paintwork.

CAUTION

DETERGENTS POLLUTE WATER. THEREFORE THE VEHICLE SHOULD BE WASHED IN AN AREA EQUIPPED FOR THE COLLECTION AND PURIFICATION OF THE LIQUIDS USED.

WARNING

NEVER WASH THE VEHICLE UNDER DIRECT SUNLIGHT, ESPECIALLY IN SUMMER WHEN THE BODYWORK IS STILL HOT, AS THE CAR SHAMPOO MAY DRY BEFORE BEING RINSED OFF, AND COULD DAMAGE THE PAINTWORK. NEVER USE RAGS SOAKED IN PETROL OR DIESEL OIL TO CLEAN THE PAINTED OR PLASTIC SURFACES, IN ORDER TO PREVENT THEM LOSING THEIR SHINE AND MECHANICAL CHARACTERISTICS.

WARNING

WHEN WASHING THE ENGINE WITH A HIGH-PRESSURE WATER JET:

- ONLY USE FAN SPRAY JETS.
- DO NOT PLACE THE NOZZLE CLOSER THAN 60 CM.
- DO NOT USE WATER AT TEMPERATURES OVER 40° C.
- DO NOT DIRECT THE JETS DIRECTLY TO CARBURETTOR, WIRINGS, SLOT DIFFUSERS ON THE TRANSMISSION COVER AND SCROLL COVER.

DIFFICULT STARTING

No fuel in tank	Refuel
Filters, jets or carburettor body dirty or clogged.	Contact an Authorised Service Centre .
Insufficient battery charge	Kick-start. Recharge the battery.

IGNITION PROBLEMS

No spark from spark plug. Due to the presence of high voltage, this check should only be carried out by an expert.	Check that the electrodes are properly adjusted (0.7÷ 0.8 mm). Check that the electrodes are clean (clean with pure petrol and metal brush or with emery cloth). Check the spark plug insulator: Replace the spark plug if the insulator is cracked or broken. If the spark plug is in good condition, contact an Authorised Piaggio Service Centre .
--	---

LACK OF COMPRESSION

Spark plug adapter "worn", valve clearance not adequate; worn piston gas rings	Contact an Authorised Service Centre .
--	---

HIGH CONSUMPTION AND LOW PERFORMANCE

Air filter blocked or dirty.	Clean with water and shampoo and impregnate with petrol and specific oil («Air filter removal» section)
------------------------------	---

INEFFICIENT BRAKING

Oil on drum or disc. Worn Pads/ Shoes	Contact an Authorised Service Centre
--	---

incorrect rear brake adjustment	Adjust
---------------------------------	--------

INEFFICIENT SUSPENSION

Oil leak; worn limit switch bumpers; worn shock absorber attachment points	Contact an Authorised Service Centre
--	---

AUTOMATIC TRANSMISSION PROBLEMS

Deteriorated roller housing or belt.	Contact an Authorised Service Centre.
--------------------------------------	--

INCREASED EXHAUST NOISE

Deterioration of the SAS system and/or of the tab	Contact an Authorised Service Centre.
--	--

STAND DOES NOT RETURN TO POSITION

Presence of dirt

Clean and grease

STARTER LEVER DOES NOT RETURN TO CORRECT POSITION

Presence of dirt

Clean and grease

VESPA Vespa LX 50 4T



Chap. 04
Technicaldata

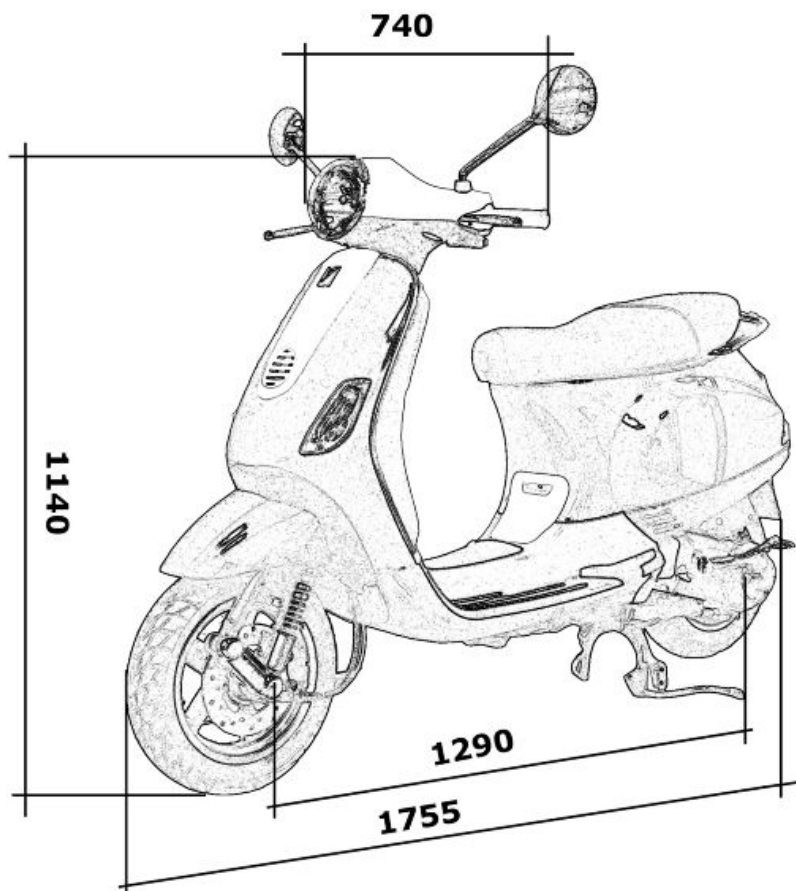

TECHNICAL SPECIFICATIONS

Engine type	Single cylinder, 4-stroke, Piaggio Hi-PER4
Engine capacity	49.9 cc
Bore x stroke	39 X 41.8 mm
Compression ratio	11.5 :1
Length	1755 mm
Width	740 mm
Maximum height	1140 mm
Wheelbase	1290 mm
Fuel	Unleaded petrol
Chassis	Unitised body made of stamped plate.
Fuel tank capacity	~ 8.5 l (2 l of which is reserve)
Timing system	Single overhead camshaft (SOHC) with 2 valves
Start-up	Electrical and kick starter
Lubrication	Wet crankcase
Cooling	Forced-circulation air cooling.
Depression carburettor	KEIHIN CVK 18
Spark plug	NGK CR 8EB
Alternative spark plug	DENSO U24ESR-NB

Transmission	Automatic variator CVT with torque server.
Clutch	Automatic centrifugal dry clutch
Steering and suspensions	Fulcrum steering tube on the front wheel-holder hub; helicoidal spring suspension and double-acting hydraulic shock absorber; rear with single chamber hydraulic shock absorber and coaxial spring not adjustable at preloading
Rear tyre	Tubeless; 120/70-10"
Front tyre	Tubeless; 110/70-11"
Rear wheel rim	Die-cast aluminium alloy; 3.00 x 10"
Front wheel rim	Die-cast aluminium alloy; 2.50 x 11"
Front brake	Disc brake (Ø 200 mm) with hydraulic control (lever on the far right of the handlebar) and fixed calliper.
Rear brake	Ø110 mm drum brake
Type approval	Euro 2
Dry weight	102±5

Toolkit

Spanners: one box wrench (16 mm); a double screwdriver. The tools are located in a toolbox under the saddle.

VESPA Vespa LX 50 4T



Chap. 05
Spareparts and
accessories



Warnings (05_01, 05_02)

WARNING



IT IS RECOMMENDED THAT "ORIGINAL PIAGGIO SPARE PARTS" BE USED, AS THESE ARE THE ONLY ONES OFFERING YOU THE SAME QUALITY ASSURANCE AS THOSE INITIALLY FITTED ON THE VEHICLE.

IT SHOULD BE REMEMBERED THAT USING NON-ORIGINAL SPARE PARTS CAUSES YOUR WARRANTY RIGHTS TO EXPIRE.

WARNING



PIAGGIO MARKETS ITS OWN LINE OF ACCESSORIES THAT ARE RECOGNISED AND GUARANTEED FOR USE. IT IS THEREFORE ESSENTIAL TO CONTACT AN AUTHORISED DEALER OR SERVICE CENTRE IN ORDER TO CHOOSE AND FIT ACCESSORIES CORRECTLY. THE USE OF NON-ORIGINAL ACCESSORIES MAY AFFECT THE STABILITY AND OPERATION OF YOUR VEHICLE AND REDUCE SAFETY LEVELS WITH POTENTIAL RISKS FOR THE RIDER.



VESPA Vespa LX 50 4T



Chap. 06
Scheduled maintenance



Scheduled servicing table (06_01)

Adequate maintenance is fundamental to ensuring long-lasting, optimum operation and performance of your vehicle.

To this end, a series of checks and maintenance operations (at the owner's expense) have been suggested, which are included in the summary table on the following page. Any minor faults should be reported without delay to an **Authorised Service Centre or Dealer** without waiting until the next scheduled service to solve it.

It is indispensable to have your vehicle serviced to the prescribed intervals of time, even if you have not reached the predicted mileage. Punctual vehicle servicing is necessary for the correct use of the guarantee. For any further information concerning Warranty procedures and 'Scheduled Maintenance', please refer to the 'Warranty Booklet'.

SCHEDULED MAINTENANCE TABLE

Km x 1000	1	3	6	9	12	15	18	21	24	27	30	33	36	39	42	45	48	51	54	57	60	
Safety fasteners	I				I				I				I				I					I
Spark plug			R		R		R		R		R		R		R		R		R		R	R
Drive belt			I		R		I		R		I		R		I		R		I		R	R
Throttle control	A				A				A				A				A					A
Tyre condition and wear					I				I				I				I					I
Air filter					C				C				C				C					C
Oil filter (mesh)			C		C		C		C		C		C		C		C		C		C	C
Solenoid filter			C		C		C		C		C		C		C		C		C		C	C
Valve clearance	I				I				I				I				I					I

Km x 1000	1	3	6	9	12	15	18	21	24	27	30	33	36	39	42	45	48	51	54	57	60
Electrical system and battery	I		I		I		I		I		I		I		I		I		I		I
Cylinder ventilation system									I								I				
Brake levers	L				L				L				L				L				L
Brake oil level (*)	I		I		I		I		I		I		I		I		I		I		I
Hub oil level	R		I		R		I		R		I		R		I		R		I		R
Engine oil	R	I	R	I	R	I	R	I	R	I	R	I	R	I	R	I	R	I	R	I	R
Brake Pads/Shoes	I		I		I		I		I		I		I		I		I		I		I
Tyre pressure	I		I		I		I		I		I		I		I		I		I		I
Headlight					A				A				A				A				A
Vehicle road test	I		I		I		I		I		I		I		I		I		I		I
Idle speed	A				A				A				A				A				A
Odometer gear					L				L				L				L				L
CVT rollers			I		R		I		R		I		R		I		R		I		R
Suspension					I				I				I				I				I
Steering	A				A				A				A				A				A
Transmission					L				L				L				L				L

I: CHECK AND CLEAN, ADJUST, LUBRICATE OR REPLACE IF NECESSARY.

C: CLEAN, R:REPLACE, A: ADJUST, L:LUBRICATE

** Replace every 2 years*

RECOMMENDED PRODUCTS TABLE

Product	Description	Specifications
AGIP GEAR SAE 80W-90	Lubricant for gearboxes and transmissions.	API GL-4
AGIP BRAKE 4	Brake fluid.	Synthetic fluid SAE J 1703 - FMVSS 116 - DOT 3/4 - ISO 4925 - CUNA NC 956 DOT 4
eni i-Ride PG 5W-40	Synthetic based lubricant for high-performance four-stroke engines.	JASO MA, MA2 - API SL - ACEA A3
AGIP FILTER OIL	Special product for the treatment of foam filters.	-
AGIP GREASE MU3	Yellow-brown, lithium-base, medium-fibre multipurpose grease.	ISO L-X-BCHA 3 - DIN 51 825 K3K -20
AGIP GP 330	Water repellent stringy calcium spray grease.	R.I.D./A.D.R. 2 10°b) 2 R.I.Na. 2.42 - I.A.T.A. 2 - I.M.D.G. class 2 UN 1950 Page 9022 EM 25-89

TABLE OF CONTENTS

B

Battery: 36

C

Checks: 18

Clock: 10

F

Fuses: 39

I

Identification: 14

K

Keys: 14

M

Maintenance: 27

P

Puncture: 46

R

Refuelling: 18

T

Toolkit: 56

Tyres: 31

V

Vehicle: 7



The descriptions and images in this publication are given for illustrative purposes only and are not binding. While the basic characteristics as described and illustrated in this booklet remain unchanged, Piaggio & C. S.p.A. reserves the right, at any time and without being required to update this publication beforehand, to make any changes to components, parts or accessories, which it considers necessary to improve the product or which are required for manufacturing or construction reasons.

Not all versions/models shown in this publication are available in all countries. The availability of each model should be checked at the official PIAGGIO sales network.

© Copyright 2012 - Piaggio & C. S.p.A. All rights reserved. Reproduction of this publication in whole or in part is prohibited.

Piaggio & C. S.p.A. Viale Rinaldo Piaggio, 25 - 56025 PONTEDERA (PI), Italy

www.piaggio.com