

Vespa would like to thank you

for choosing one of its products. We have prepared this manual to help you to get the very best from your vehicle. Please read it carefully before riding the vehicle for the first time. It contains information, tips and precautions for using your vehicle. It also describes features, details and devices to assure you that you have made the right choice. We believe that if you follow our suggestions, you will soon get to know your new vehicle and it will serve you well for a long time to come. This booklet forms an integral part of the vehicle; should the vehicle be sold, it must be transferred to the new owner.

# Vespa LX 50 4v Touring



The instructions given in this manual are intended to provide a clear, simple guide to using your vehicle; this booklet also details routine maintenance procedures and regular checks that should be carried out on the vehicle at an **authorised Dealer or Service Centres**. The booklet also contains instructions for simple repairs. Any operations not specifically described in this booklet require the use of special tools and/or particular technical knowledge: to carry out these operations, refer to any **authorised Dealer or Service Centres**.



### **Personal safety**

Failure to completely observe these instructions will result in serious risk of personal injury.



### **Safeguarding the environment**

Sections marked with this symbol indicate the correct use of the vehicle to prevent damaging the environment.



### **Vehicle intactness**

The incomplete or non-observance of these regulations leads to the risk of serious damage to the vehicle and sometimes even the invalidity of the guarantee.

*The signs that you see on this page are very important. They are used to highlight parts of the booklet that should be read with particular care. The different symbols are used to make each topic in the manual simple and quick to locate.*



# INDEX

<b>VEHICLE</b> .....	7	Engine oil level check.....	32
Dashboard.....	9	Engine oil top-up.....	33
Analogue instrument panel.....	10	Engine oil change.....	33
Clock.....	11	Hub oil level.....	34
Key switch.....	12	Tyres.....	35
Locking the steering wheel.....	13	Spark plug dismantlement.....	36
Releasing the steering wheel.....	13	Removing the air filter.....	37
Switch direction indicators.....	13	Secondary air system.....	38
Horn button.....	14	Checking the brake oil level.....	39
Light switch.....	14	Braking system fluid top up.....	40
Start-up button.....	15	Battery.....	41
Fuel tank.....	15	Use of a new battery.....	42
Opening the saddle.....	16	Long periods of inactivity.....	43
Keys.....	16	Fuses.....	44
Identification.....	16	Front light group.....	48
Rear top box opening.....	18	Headlight adjustment.....	50
Bag clip.....	18	Front direction indicators.....	51
<b>USE</b> .....	19	Rear optical unit.....	52
Checks.....	20	Rear turn indicators.....	53
Refuelling.....	20	Rear-view mirrors.....	54
Tyre pressure.....	21	Idle adjustment.....	55
Running in.....	22	Front disc brake.....	56
Starting up the engine.....	23	Rear drum brake.....	57
Difficult start up.....	24	Puncture.....	57
Stopping the engine.....	25	Periods of inactivity.....	58
Anti-theft ring.....	26	Cleaning the vehicle.....	59
Catalytic silencer.....	26	<b>TECHNICAL DATA</b> .....	65
Stand.....	27	Toolkit.....	70
Automatic transmission.....	27	<b>SPARE PARTS AND ACCESSORIES</b> .....	71
Safe driving.....	28	Warnings.....	72
Rear rack.....	30	<b>SCHEDULED MAINTENANCE</b> .....	73
<b>MAINTENANCE</b> .....	31	Scheduled servicing table.....	74
Engine oil level.....	32		



# Vespa LX 50 4v Touring

**Vespa®**



**Chap. 01  
Vehicle**

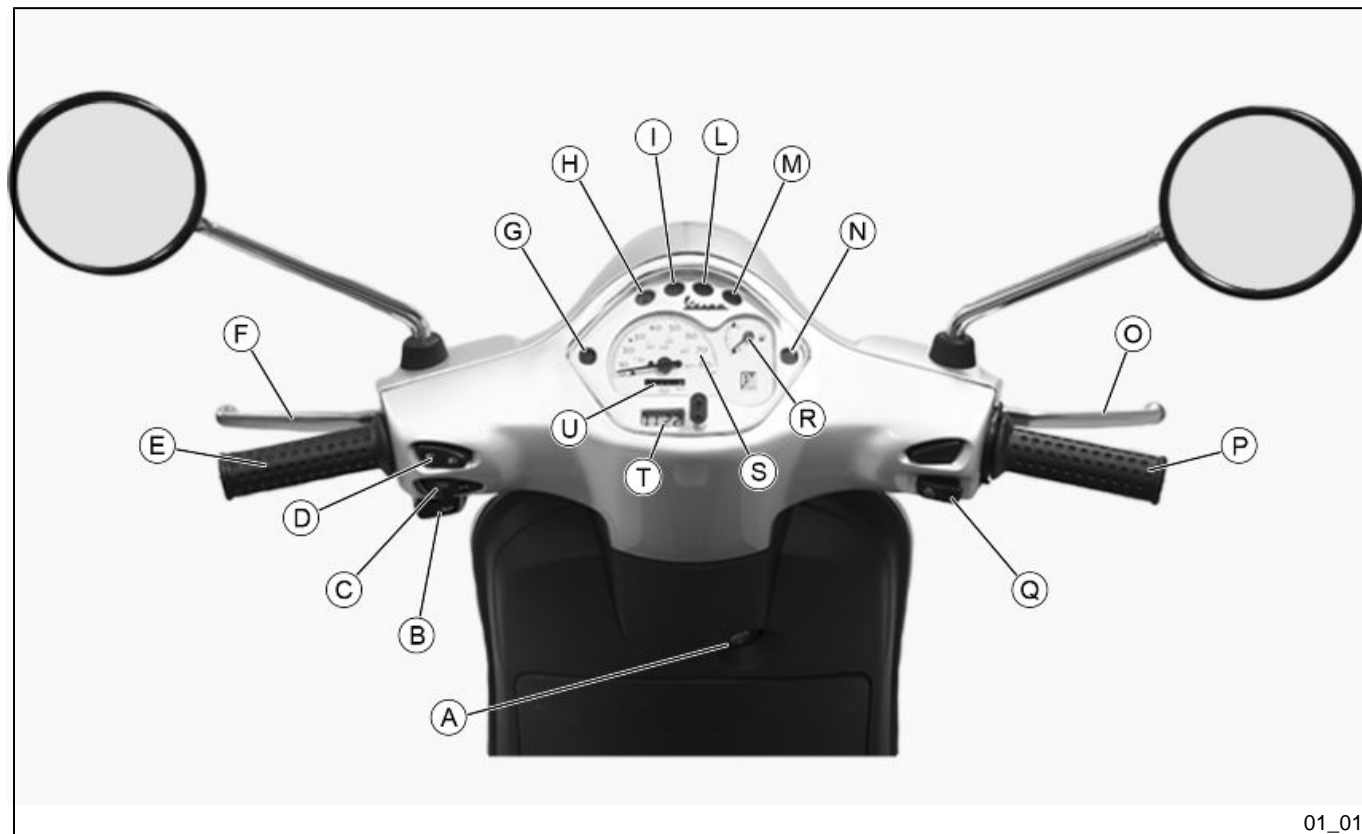



## Dashboard (01\_01)

**A** = Ignition key-switch

**B** = Horn button

**C** = Turn indicator switch

**D** = Light switches

**E** = Left hand grip

**F** = Rear brake control lever

**G** = Left turn indicator warning light

**H** = Low fuel warning light

**I** = Not used

**L** = High-beam warning light

**M** = Taillights/low-beam lights warning light

**N** = Right turn indicator warning light

**O** = Front brake control lever

**P** = Throttle grip

**Q** = Start-up button

**R** = Fuel gauge

**S** = Speedometer

**T** = Digital clock

**U** = Odometer

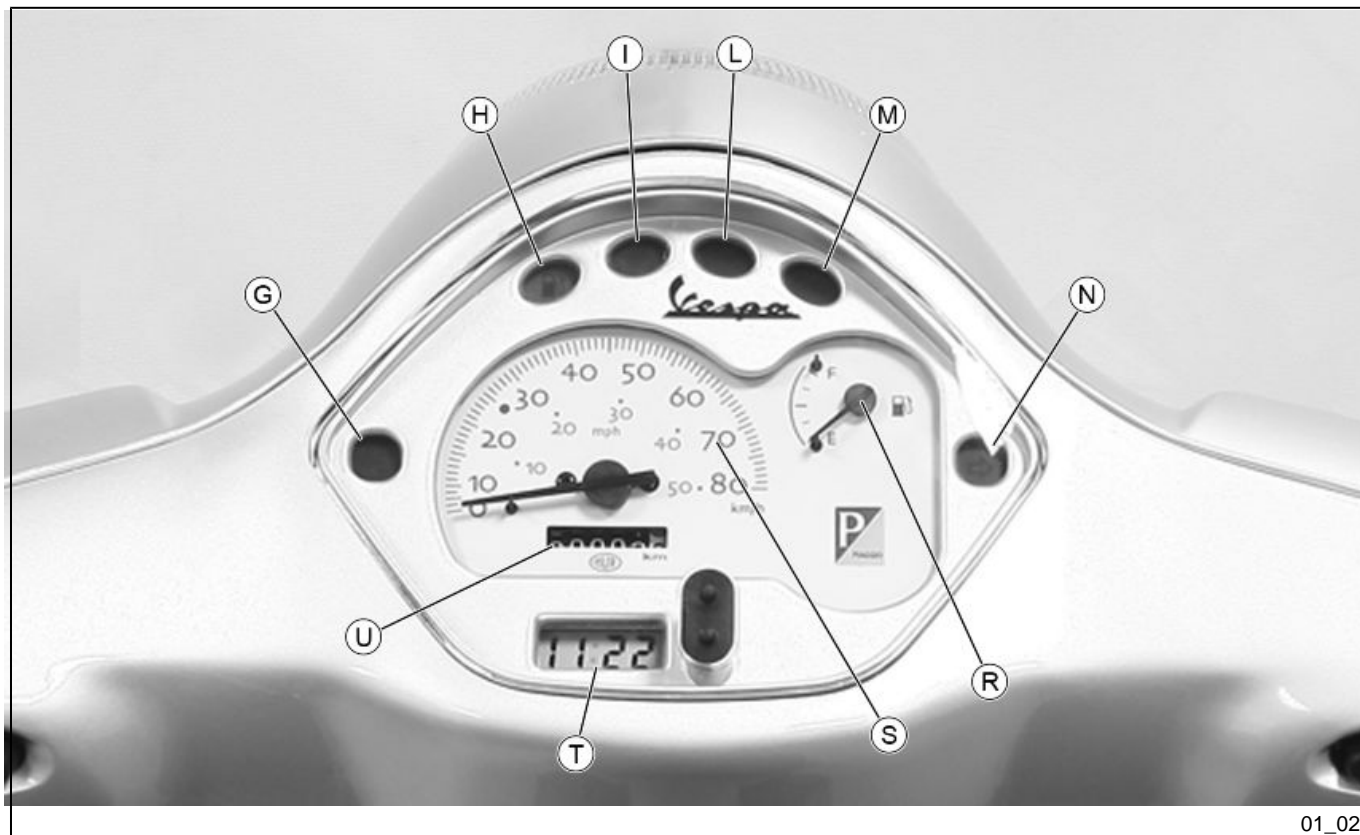

01\_02

### Analogue instrument panel (01\_02)

G = Left turn indicator warning light

**H** = Low fuel warning light

**I** = Not used

**L** = High-beam warning light

**M** = Taillights/low-beam lights warning light

**N** = Right turn indicator warning light

**R** = Fuel gauge

**S** = Speedometer

**T** = Digital clock

**U** = Odometer

### **Clock (01\_03)**

Located in the instrument panel, it displays hours and minutes with 1 to 12-hour time, AM or PM.

Operate the function selection button «**B**» and month, day and seconds are also displayed besides hours and minutes.

To adjust the different functions, select the desired function with button «**A**» and adjust with button «**B**». The time counter can be reset by pressing button «**A**» with the clock in the seconds function.

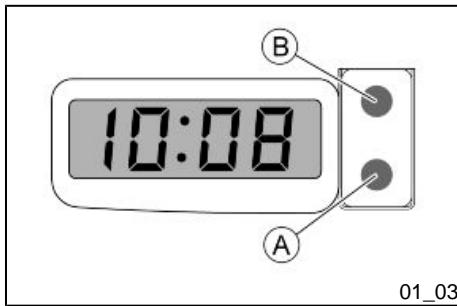

01\_03

The digital clock is powered by a battery (battery life is about 2 years); lift the whole instrument panel to replace the battery. It is advisable to take your vehicle to an **Authorised Service Centre** for this operation.

#### WARNING



**DEAD BATTERIES ARE HARMFUL TO THE ENVIRONMENT. THEY MUST BE DISPOSED OF IN SUITABLE CONTAINERS AS PRESCRIBED BY THE REGULATIONS IN FORCE.**

### Key switch (01\_04)

The key switch «A» is located on the knee-guard panel.

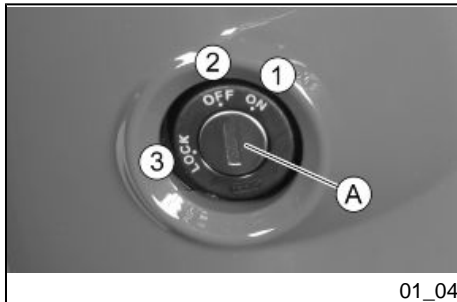

01\_04

#### SWITCH POSITIONS

**ON «1»:** Ready to start position, non-extractable key, mechanical antitheft device disabled.

**OFF «2»:** Ignition disabled, extractable key, mechanical antitheft device disabled.

**LOCK «3»:** Ignition disabled, extractable key, mechanical antitheft device enabled.

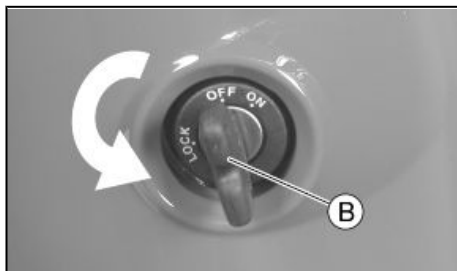

01\_05

### Locking the steering wheel (01\_05)

Turn the handlebar to the left as far as it will go; turn the key «B» to «LOCK» and remove it.

#### CAUTION



**DO NOT TURN THE KEY TO «LOCK» OR «KEY OFF» WHILE RIDING.**

### Releasing the steering wheel

Reinsert the key «B» and turn it to «KEY OFF».

#### CAUTION



**DO NOT TURN THE KEY TO «LOCK» OR «KEY OFF» WHILE RIDING.**

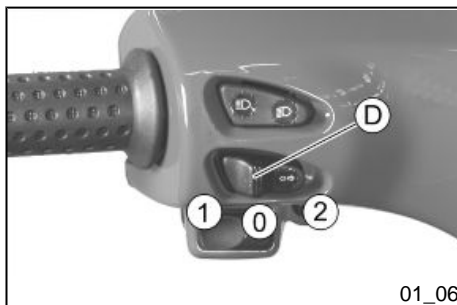

01\_06

### Switch direction indicators (01\_06)

Lever «D» towards «1» = left turn indicators switched on;

Lever «D» towards «2» = right turn indicators switched on;

The lever «D» automatically goes back to «0» and the turn indicators remain on; push the lever «D» to turn them off.

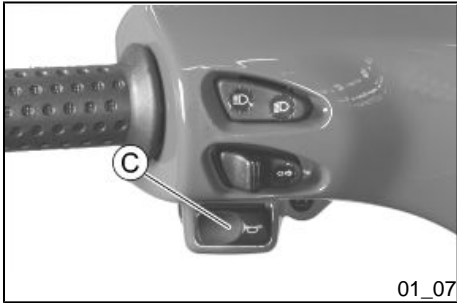

### Horn button (01\_07)

Push the «C» button to sound the horn.

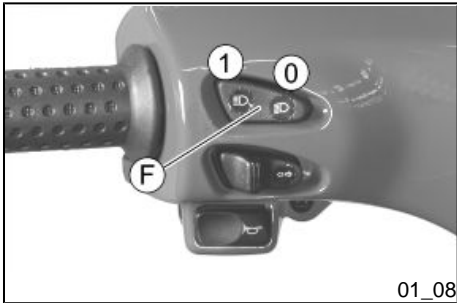

### Light switch (01\_08)

When the light switch «F» is set to «0», the low-beam light is on. When set to «1», the high-beam light is activated.

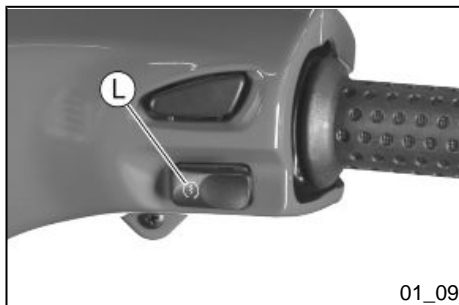

### Start-up button (01\_09)

To start the engine, pull either of the two brake levers and then push the button «L».

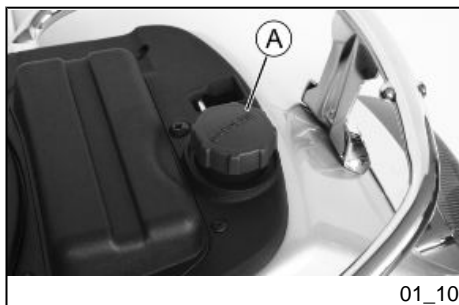

### Fuel tank (01\_10)

The fuel tank cap «A» is under the saddle. To reach it, tip the saddle forwards.

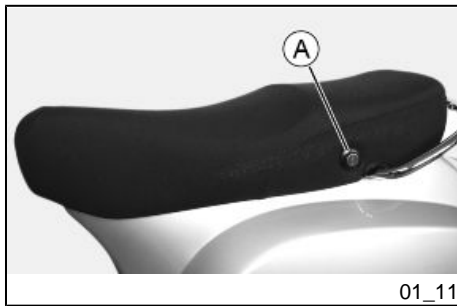

### Opening the saddle (01\_11)

Insert the key into the saddle lock «A», turn it anticlockwise and tip the saddle forward.



### Keys (01\_12)

The vehicle is supplied with two keys (one spare) which serve to start the engine and unlock the saddle compartment. The keys are accompanied by a tag marked with the identification code to be quoted when ordering duplicates.

#### **WARNING**

**WE RECOMMEND KEEPING THE DUPLICATE KEY TOGETHER WITH ITS CODE IN A SAFE PLACE AND NOT ON THE VEHICLE**

### Identification (01\_13, 01\_14)

Identification registration numbers are made up of a prefix and a number, stamped on the chassis and on the engine. These numbers must always be quoted when ordering spare parts. We recommend checking that the chassis registration number stamped on the vehicle corresponds with that on the vehicle documentation.



**CAUTION**

**BE REMINDED THAT ALTERING IDENTIFICATION REGISTRATION NUMBERS CAN LEAD TO SERIOUS PENAL SANCTIONS (IMPOUNDING OF THE VEHICLE, ETC.).**

**Chassis number**

The number «**A**» is stamped near the battery compartment. Remove the helmet compartment to read it.

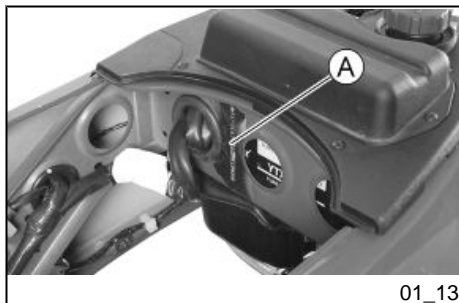
**Engine number**

The engine number «**B**» is stamped near the rear left shock absorber lower support.

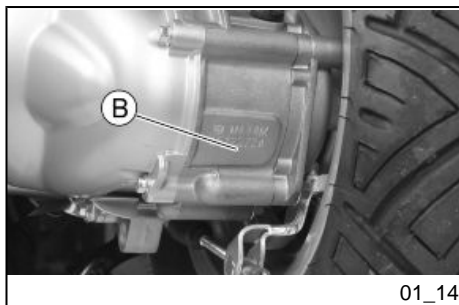



### Rear top box opening (01\_15)

Turn the key to «OFF». Then press it. When the key is set to «LOCK», the glove-box is locked.

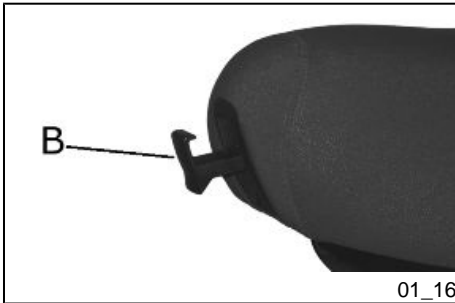

### Bag clip (01\_16)

To use the retractable bag hook «B» located at the front end of the saddle, pull it forward lightly.

# Vespa LX 50 4v Touring

**Vespa®**



**Chap. 02**  
**Use**

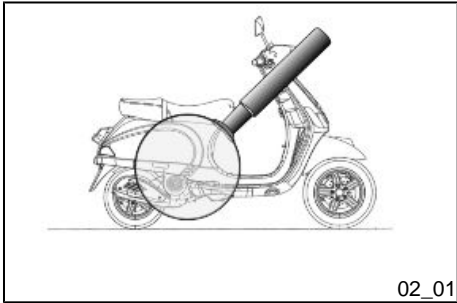

## Checks (02\_01)

Before using the vehicle, check:

1. that the fuel tank is full.
2. The oil level in the rear hub.
3. engine oil level (see section «Engine oil level»).
4. That tyres are properly inflated.
5. correct functioning of headlights, rear taillight and turn indicators.
6. The correct functioning of the front and rear brakes.

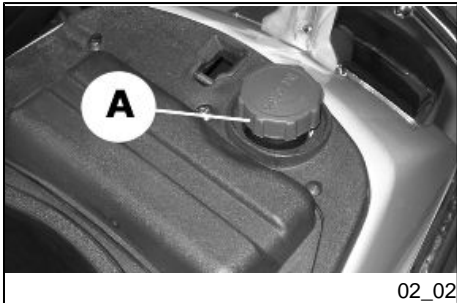

## Refuelling (02\_02)

Fill fuel tank «A» with unleaded petrol (minimum octane rating = 95).

When the fuel reaches the reserve level, the warning light fitted on the instrument panel lights up.

### CAUTION



**SHUT OFF THE ENGINE BEFORE REFUELLING WITH PETROL. PETROL IS HIGHLY FLAMMABLE. DO NOT LET PETROL SPILL FROM THE TANK OR WHILE REFUELLING**

### CAUTION



**DO NOT BRING NAKED FLAMES OR CIGARETTES NEAR THE MOUTH OF THE FUEL TANK: FIRE HAZARD. ALSO AVOID INHALING HARMFUL VAPOURS.**

**CAUTION**

USING OILS OTHER THAN THOSE RECOMMENDED CAN SHORTEN THE LIFE OF THE ENGINE.

**Characteristic****Fuel tank capacity**

~ 8.5 l (2 l of which is reserve)

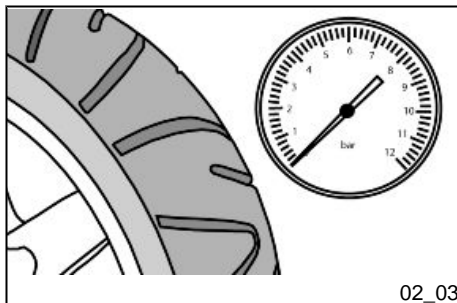
**Tyre pressure (02\_03)**

Check tyre pressure as indicated in the scheduled maintenance table.

**CAUTION**

**TYRE PRESSURE SHOULD BE CHECKED WHEN TYRES ARE COLD. INCORRECT TYRE PRESSURE CAUSES ABNORMAL TYRE WEAR AND MAKES RIDING DANGEROUS.**

**TYRES MUST BE REPLACED WHEN THE TREAD REACHES THE WEAR LIMITS SET FORTH BY LAW.**

**TYRE INFLATION PRESSURE**

Front tyre pressure (with passenger)

1.6 bar (1.6 bar)

Rear tyre pressure (with passenger)	2.0 bar (2.3 bar)
-------------------------------------	-------------------

## **TYRES**

Front tyre	Tubeless, 110/70 - 11" 45L
------------	----------------------------

Rear tyre	Tubeless, 120/70 - 10" 54L
-----------	----------------------------

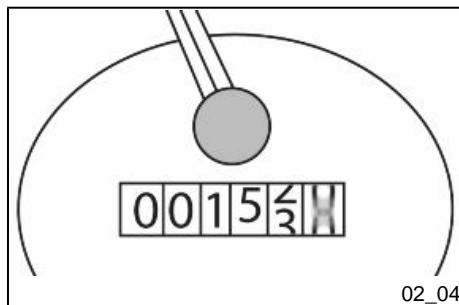

### **Running in (02\_04)**

#### **WARNING**



**DURING THE FIRST 1000 KM DO NOT RIDE THE VEHICLE OVER 80% OF ITS MAXIMUM SPEED. AVOID TWISTING THE THROTTLE GRIP FULLY OR KEEPING A CONSTANT SPEED ALONG LONG SECTIONS OF ROAD. AFTER THE FIRST 1000 KM, GRADUALLY INCREASE SPEED UNTIL REACHING THE MAXIMUM PERFORMANCE.**



02\_05

## Starting up the engine (02\_05, 02\_06, 02\_07, 02\_08)

The vehicle is fitted with automatic transmission with a regulator and centrifugal clutch. Therefore always start the engine with the throttle at idle speed; to start-off from stationary position, progressively twist the throttle grip.

The vehicle is equipped with a fuel valve and a starter which switch on automatically as soon as the engine is started.

To start it up, it is necessary to:

1. Place the scooter on its stand «E»; check that the rear wheel is off the ground.
2. Keep the throttle grip to idle speed.
3. Insert the key into the switch «D» and turn it to «ON».
4. Pull the rear brake lever «B» or the front brake lever «C» and then press the starter button «A».

### CAUTION



**DO NOT CARRY OUT THESE OPERATIONS IN CLOSED AREAS SINCE EXHAUST GASES ARE TOXIC.**

### CAUTION



**DUE TO THE HIGH TEMPERATURES THE CATALYTIC CONVERTER CAN REACH, ALWAYS TAKE CARE, WHEN PARKING THE VEHICLE, THAT THE EXHAUST DOES NOT COME INTO CONTACT WITH FLAMMABLE MATERIALS, TO AVOID SERIOUS BURNS.**

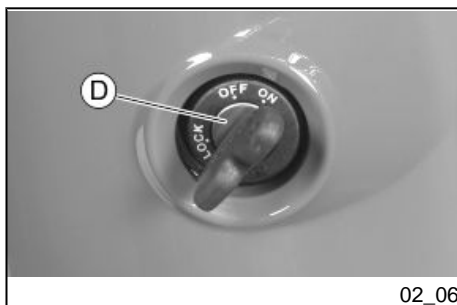

02\_06

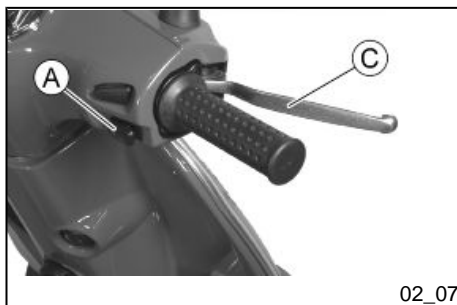

02\_07

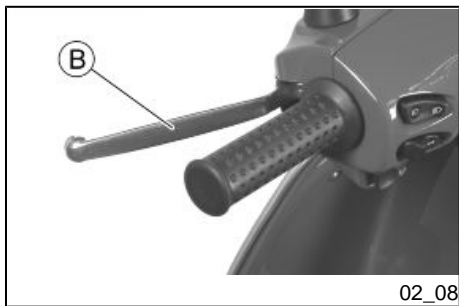

02\_08



02\_09

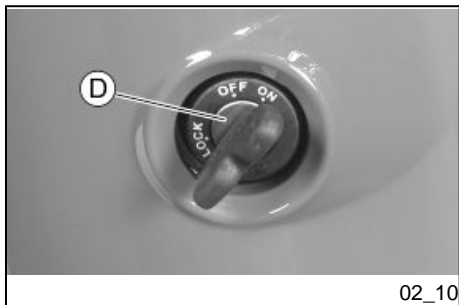

02\_10

### Difficult start up (02\_09, 02\_10, 02\_11)

If there is a problem you can follow the instructions below:

**1. Engine flooded.** Place the vehicle on its centre stand and check that the rear wheel is off the ground. Open the throttle fully and press the starter button for five seconds, let the engine sit for a few minutes and then repeat the above operations. In any case do not operate the starter motor longer than 20" in an attempt to start the engine.

**2. Battery or starter motor inefficiency.** Put the scooter on its stand "E"; make sure that the rear wheel is off the ground, turn the key switch «D» to «ON» and use the kick-starter «F».

**3. Empty fuel tank.** After refuelling the scooter, start the engine by pressing the starter button «A» with the throttle at a minimum to provide maximum aspiration for the tap. If the vehicle fails to start even after carrying out the steps described above, contact an **Authorised Service Centre**.

#### CAUTION



**ALWAYS PLACE THE VEHICLE ON ITS STAND BEFORE KICK STARTING.**

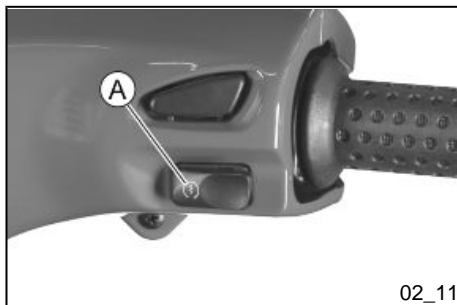

**WARNING**

TAMPERING MAY CAUSE SERIOUS ENGINE MALFUNCTION.

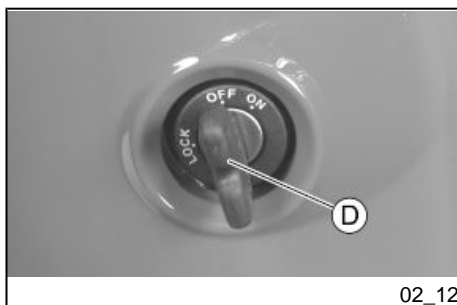
**Stopping the engine (02\_12)**

Stop acceleration, then turn the key switch «D» to «OFF » to stop the engine (extractable key).

**CAUTION**

DUE TO THE HIGH TEMPERATURES THE CATALYTIC CONVERTER CAN REACH, ALWAYS TAKE CARE, WHEN PARKING THE VEHICLE, THAT THE EXHAUST DOES NOT COME INTO CONTACT WITH FLAMMABLE MATERIALS, TO AVOID SERIOUS BURNS.

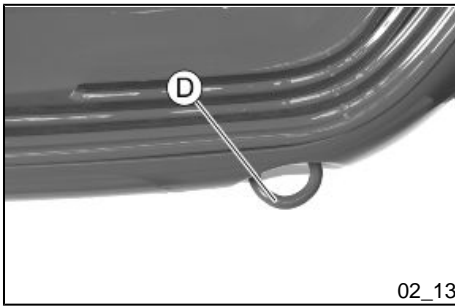

02\_13

### Anti-theft ring (02\_13)

The «D» ring on the right side of the vehicle is used to fasten the vehicle to an object using a scooter chain. Do not use the ring for other purposes.

#### WARNING



**THIS ACCESSORY IS NOT A THEFT PREVENTION GUARANTEE, IT IS ONLY A DETERRENT.**

### Catalytic silencer

#### CAUTION



**TAMPERING WITH THE CATALYTIC SILENCER MAY CAUSE SEVERE DAMAGE TO THE ENGINE**

.

#### CAUTION



**WHEN PARKING THE VEHICLE, DUE TO THE HIGH TEMPERATURES THE CATALYTIC CONVERTER CAN REACH, ALWAYS BE CAREFUL THAT THE MUFFLER DOES NOT COME INTO CONTACT WITH FLAMMABLE MATERIALS, TO AVOID SERIOUS BURNS.**

**CAUTION**

**DO NOT SHUT OFF THE ENGINE WHILE THE VEHICLE IS MOVING. UNBURNED FUEL COULD ENTER THE CATALYTIC CONVERTER AND BURN, CAUSING THE CONVERTER TO OVERHEAT AND POSSIBLY DESTROYING IT.**

**Stand (02\_14)**

Lower the centre stand «F» by kicking the bracket while pulling the vehicle backward, holding onto the handlebar.

**Automatic transmission (02\_15)**

To ensure simple, pleasurable riding, the vehicle is equipped with automatic transmission with regulator and centrifugal clutch. The system is designed to give the best possible performance in terms of both acceleration and consumption, on level ground and uphill, thanks to the adjustments made to engine speed and transmitted torque. If you have to stop on an uphill slope (traffic lights, traffic jam, etc.) only use the brake to keep the vehicle still, leaving the motor running at idling speed. Using the motor to keep the vehicle still can cause the clutch to overheat. This problem is due to the friction of the clutch parts on the clutch bell. It is therefore recommended to avoid conditions of prolonged clutch slippage leading to clutch overheating (for example, as



well as the situation described above, riding uphill fully laden on steep slopes or starting off on slopes greater than 25%, etc.):

1. Do not continue riding in such conditions.
2. Let the clutch cool down with the motor at idling speed for a few minutes.



### **Safe driving (02\_16)**

Some simple tips are provided below that will enable you to use your vehicle on a daily basis, confidently and safely. Your skill and your mechanical knowledge are the basis of safe riding. We recommend trying out the vehicle in traffic-free zones to familiarise with it.

1. Before riding off, remember to put on your helmet and fasten it correctly.
2. Reduce speed on rough roads and ride with care.
3. After riding on a long stretch of wet road without using the brakes, braking can be poor at the beginning. Under these conditions, it is a good idea to operate the brakes from time to time.
4. Do not brake hard on wet, dirt or slippery road surfaces.
5. Avoid riding off by mounting the scooter when resting on the support. In any case, the rear wheel should not be turning when it comes into contact with the ground, in order to avoid abrupt departures.
6. When riding the vehicle on roads with sand, mud, snow mixed with salt, etc., we recommend that you clean the brake disc frequently with a non-aggressive detergent in order to avoid the formation of abrasive build-ups in the holes, which could result in early wear of brake pads.

**CAUTION**

**ALWAYS RIDE WITHIN YOUR LIMITS RIDING UNDER THE INFLUENCE OF ALCOHOL OR OTHER DRUGS AND CERTAIN MEDICINES IS EXTREMELY DANGEROUS.**

**CAUTION**

**ANY ELABORATION THAT MODIFIES THE VEHICLE'S PERFORMANCES, SUCH AS TAMPERING WITH ORIGINAL STRUCTURAL PARTS IS STRICTLY FORBIDDEN BY LAW, AND RENDERS THE VEHICLE NO LONGER CONFORMING TO THE APPROVED TYPE AND DANGEROUS FOR RIDING.**

**CAUTION**

**DO NOT ADJUST THE MIRRORS WHILE RIDING. THIS COULD CAUSE YOU TO LOOSE CONTROL OF THE VEHICLE.**

**WARNING**

**IN ORDER TO PREVENT ANY ACCIDENTS RIDE VERY CAREFULLY AFTER ADDING ACCESSORIES AND WHILE CARRYING LUGGAGE. THE ADDITION OF ACCESSORIES AND LUGGAGE CAN REDUCE YOUR SCOOTER STABILITY AND PERFORMANCE, AS WELL AS THE LEVEL OF SAFETY DURING USE. (SEE THE «SPARE PARTS AND ACCESSORIES» SECTION)**



02\_17

## Rear rack (02\_17, 02\_18, 02\_19)

The vehicle is fitted with front luggage rack. Pay attention also that the load does not interfere with the light beams of the front light unit as shown in the figure.

The driver will have to be specially careful when using the vehicle with the luggage rack loaded in order to ensure safe riding and manoeuvring.

The maximum allowed net load is 4 Kg.

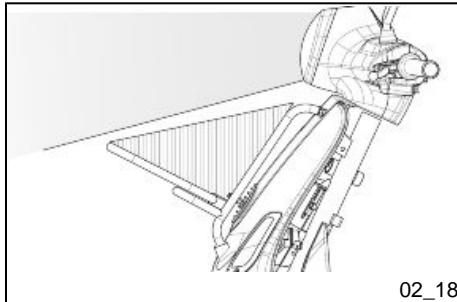

02\_18

### CAUTION



**IN CASE OF WINDSHIELD INSTALLATION, BE CAREFUL WHEN RIDING SINCE THE VEHICLE IS LESS STABLE WHEN THE LUGGAGE RACK IS INSTALLED AND LOADS ARE LOADED IN THE FRONT LUGGAGE RACK. THEREFORE, REDUCE SPEED AND BE MORE CAREFUL, ESPECIALLY WHEN APPROACHING OTHER VEHICLES.**



02\_19

To remove the front luggage rack from the vehicle, undo the three screws indicated in the figure.

# Vespa LX 50 4v Touring

**Vespa®**



**Chap. 03  
Maintenance**

## Engine oil level

In 4T engines, the engine oil is used to lubricate the distribution elements, the bench bearings and the thermal group. **An insufficient quantity of oil can seriously damage the engine.** In all 4T engines the decay of oil characteristics as well as some consumption is normal. Consumption can particularly reflect the conditions of use (i.e. when driving at 'full acceleration' all the time, oil consumption increases).

**In order to avoid problems, it is advisable to control oil level every time the vehicle is used.**

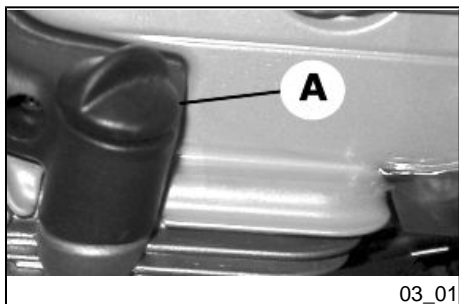

### Engine oil level check (03\_01, 03\_02)

Check oil level every time the vehicle is used, with the engine cold. The level should be between the MAX and MIN marks on the oil level dipstick "A" shown in the figure; the stand should be firm on an even surface during the check.

If the check is carried out after the vehicle has been used, and therefore with a hot engine, the level line will be lower; in order to carry out a correct check, wait at least 10 minutes after the engine has been stopped so as to get the correct level.

Check by pushing the dipstick all the way into the hole.

#### CAUTION



**RUNNING THE ENGINE WITH INSUFFICIENT LUBRICATION OR WITH THE WRONG LUBRICANTS MAY INCREASE WEAR AND TEAR ON THE MOVING PARTS AND MAY CAUSE SERIOUS DAMAGE.**

#### Characteristic

Engine oil

Capacity: ~ 850 cm<sup>3</sup>

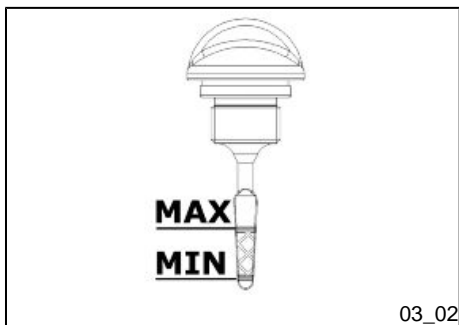



## Engine oil top-up

Always check oil level before carrying out top-ups and add oil **without exceeding the MAX level**. An engine oil check-up and top-up should be carried out every 3,000 km at an **Authorised Piaggio Service Centre**.

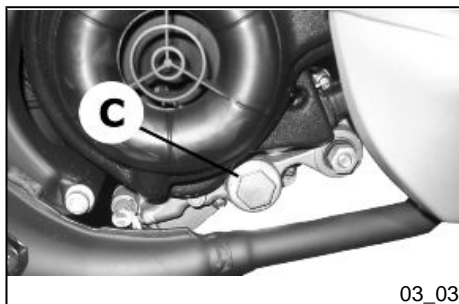

03\_03

## Engine oil change (03\_03)

Change oil and clean the filter after every 6,000 km at an **Authorised Service Centre**. Empty the engine by draining the oil through drainage cap «C» with a cold engine. First unscrew the cap-dipstick used to check engine oil level, then cap «C» and take out the mesh filter. After cleaning and mounting again the mesh filter, screw cap «C» and fill with oil the hole of the cap-dipstick used to check engine oil level. Then start the vehicle, leave it running for a few minutes and switch it off: 5 minutes later check oil level and, if necessary, add oil **without exceeding the MAX level**. Only use new oil of the recommend type for oil top-ups and change.

### CAUTION



**USED OILS CONTAIN SUBSTANCES HARMFUL TO THE ENVIRONMENT. FOR OIL REPLACEMENT, CONTACT AN AUTHORISED SERVICE CENTRE, WHICH IS EQUIPPED TO DISPOSE OF USED OILS IN AN ENVIRONMENTALLY FRIENDLY AND LEGAL WAY.**

## Recommended products

**AGIP CITY HI TEC 4T**

*Engine oil*

SAE 5W-40, API SL, ACEA A3, JASO MA Synthetic oil

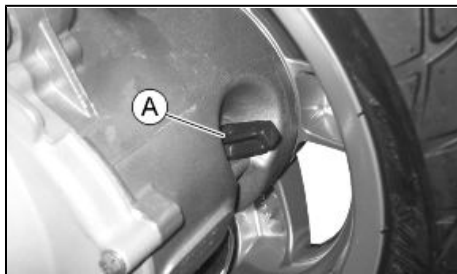

03\_04

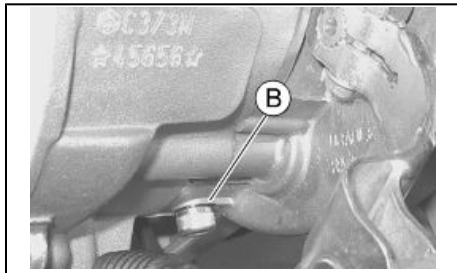

03\_05

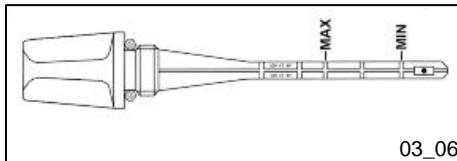

03\_06

## Hub oil level (03\_04, 03\_05, 03\_06)

To check the hub oil level, proceed as follows:

1. Place the vehicle on its stand on a level surface;
2. Unscrew the oil dipstick «A», dry it with a clean rag and then reinsert it, **screwing it tightly into place**;
3. Unscrew the dipstick again and check that the oil level barely reaches the **2nd notch from the bottom**;
4. Screw the dipstick back into place completely.

The screw «B» is the hub oil drainage plug.

### CAUTION



**RUNNING THE ENGINE WITH INSUFFICIENT LUBRICATION OR WITH THE WRONG LUBRICANTS MAY INCREASE WEAR AND TEAR ON THE MOVING PARTS AND MAY CAUSE SERIOUS DAMAGE.**

### CAUTION



**USED OILS CONTAIN SUBSTANCES HARMFUL TO THE ENVIRONMENT. FOR OIL CHANGE, CONTACT AN AUTHORISED SERVICE CENTRE WHICH IS EQUIPPED TO DISPOSE OF USED OILS IN AN ENVIRONMENTALLY FRIENDLY AND LEGAL WAY.**

### N.B.

**THE NOTCHES ON THE HUB OIL LEVEL DIPSTICK, EXCEPT THOSE INDICATING THE MAXIMUM AND MINIMUM LEVELS, REFER TO OTHER MODELS BY THE MANUFACTURER, AND HAVE NO SPECIFIC FUNCTION FOR THIS MODEL.**

## Recommended products

**AGIP ROTRA 80W-90**

*Rear hub oil*

SAE 80W/90 Oil that exceeds the requirements of API GL3 specifications

## **Characteristic**

### **Transmission oil**

80 cm<sup>3</sup>

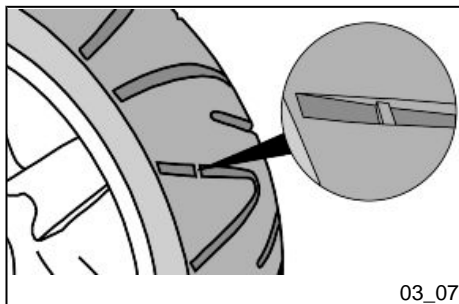

## **Tyres (03\_07)**

Periodically check the inflation pressure of each tyre (when cold).

Tyres are fitted with wear indicators; tyres should be replaced as soon as these indicators become visible on the tyre tread. Also check that the tyres do not show signs of splitting at the sidewalls or irregular tread wear; If this occurs, go to an authorised workshop or at least a workshop adequately equipped to remove and refit tyres.

### **CAUTION**



**TYRE PRESSURE SHOULD BE CHECKED WHEN TYRES ARE COLD. INCORRECT TYRE PRESSURE CAUSES ABNORMAL TYRE WEAR AND MAKES RIDING DANGEROUS.**

**TYRES MUST BE REPLACED WHEN THE TREAD REACHES THE WEAR LIMITS SET FORTH BY LAW.**

## **TYRES**

Front tyre	Tubeless, 110/70 - 11" 45L
Rear tyre	Tubeless, 120/70 - 10" 54L

## TYRE INFLATION PRESSURE

Front tyre pressure (with passenger)	1.6 bar (1.6 bar)
--------------------------------------	-------------------

Rear tyre pressure (with passenger)	2.0 bar (2.3 bar)
-------------------------------------	-------------------

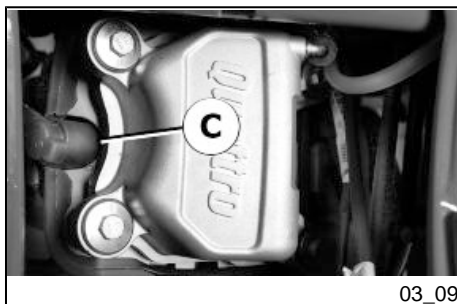
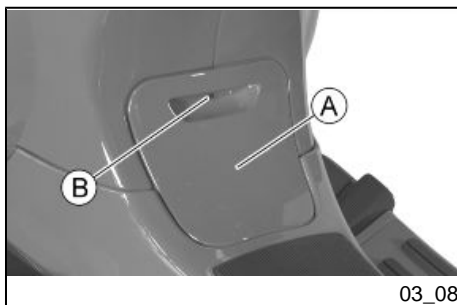

### Spark plug dismantlement (03\_08, 03\_09, 03\_10)

To make this operation easier, remove the helmet compartment.

1. Remove the cover «A» after undoing the corresponding screw «B».
2. Detach the shielded cap «C» from the spark plug and unscrew it using the box-spanner supplied as shown in the photo.
3. When refitting the plug, screw it in by hand and make sure you set it at the right angle. Carefully reinsert the shielded cap «C».
4. To refit the cover, follow the steps in reverse order, making sure to insert the tongues in the lower part of the cover in the special seat.

#### CAUTION



**FOLLOW THESE PROCEDURES VERY CAREFULLY TO AVOID ANY SEVERE DAMAGE THAT MAY BE CAUSED BY THE VERY POWERFUL IGNITION SYSTEM.**

#### CAUTION



**THE SPARK PLUG MUST BE REMOVED WHEN THE ENGINE IS COLD.**



03\_10

USING IGNITION ELECTRONIC CENTRAL UNITS OR SPARK PLUGS OTHER THAN THE TYPES PRESCRIBED (SEE «TECHNICAL DATA» SECTION) CAN CAUSE SERIOUS DAMAGE TO THE ENGINE.

#### CAUTION



PERFORM THE OPERATIONS CAREFULLY.

DO NOT DAMAGE THE TONGUES OR THEIR SEATS. HANDLE THE PAINTED AND PLASTIC COMPONENTS CAREFULLY. DO NOT SCRATCH OR DAMAGE THEM.

#### Characteristic

##### Spark plug

NGK ER9EH-6N

##### Electrode gap

0.5 ÷ 0.6 mm

#### Removing the air filter (03\_11, 03\_12)

Remove the side fairing unscrewing the 2 screws marked **A**. Remove the air cleaner cap «**D**» after unscrewing the 6 fixing screws «**C**», then remove the filtering element. Clean with water and shampoo, afterwards dry with compressed air and submerge in a recommended oil and petrol mixture in ratio of 50%. Afterwards squeeze it, leave it to dry and mount it again.



03\_11

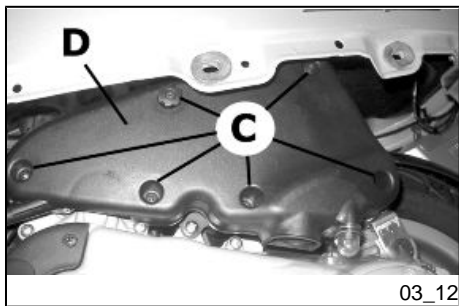

03\_12

**CAUTION**

IN CASE OF RIDING ON DUSTY ROADS IT IS ADVISABLE TO CLEAN THE AIR FILTER MORE FREQUENTLY THAN INDICATED IN THE RELEVANT CHAPTER ON SCHEDULED MAINTENANCE.



03\_13

**Secondary air system (03\_13, 03\_14, 03\_15, 03\_16)**

Undo the two screws «A» of the side fairing and remove the fairing. Undo the three screws «B» and remove the housing cover of the secondary air system. Detach the housing cover and remove the filtering element «C» made of sponge. Wash the sponge with water and neutral soap, then dry with a clean cloth and short blasts of compressed air. While cleaning the filter, check the condition of the reed valve «D», and fit it back in place on the housing.

Before closing the cover of the SAS housing, check the good condition of the sealing O-ring; replace it if damaged or deformed.

**N.B.**

The reed valve can be inserted in only one direction on the SAS housing

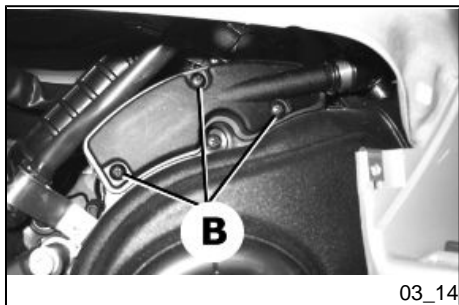

03\_14

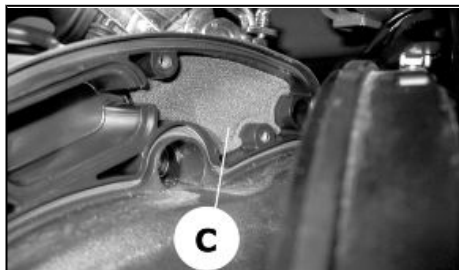

03\_15

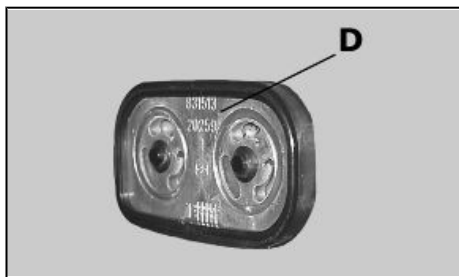

03\_16

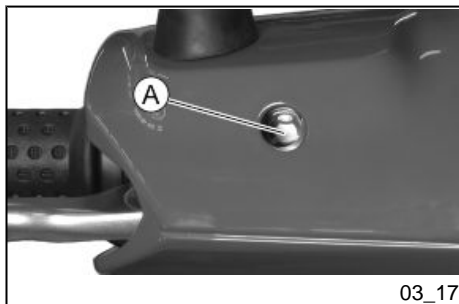

03\_17

### Checking the brake oil level (03\_17)

The brake fluid reservoir is equipped with a sight glass «A» made of transparent material; the quantity of liquid contained in the sight glass indicates the level of liquid in the reservoir.

When the sight glass «A» is full, the level inside the reservoir exceeds the MIN level; when it is partially full, the level drops to the MIN level; when it is fully empty, the level of fluid in the reservoir is below the MIN level.

The brake fluid level may fall due to wear on the brake pads. In case the pad wear is below the minimum mark, contact an **Authorised Service Centre** to have the braking system thoroughly checked.

### Braking system fluid top up (03\_18, 03\_19, 03\_20)

Proceed as follows:

1. Remove the rear-view mirrors.
2. Undo the two screws «A».
3. Undo the screw «B» and remove the front handlebar cover.
4. Remove the reservoir cover «C» by loosening the two fixing screws «D» and refill with the prescribed brake fluid type only and without exceeding the maximum level.

Under standard climatic conditions, replace fluid as indicated in the scheduled maintenance table. This operation must be carried out by trained technicians; take your scooter to an **authorised Service Centre or Dealer**.



03\_18

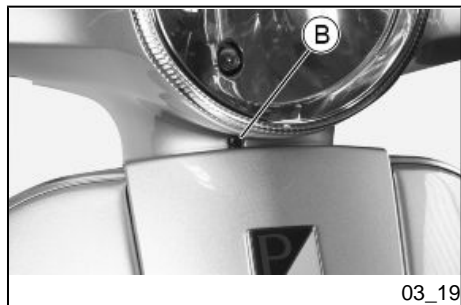

03\_19

#### WARNING



**ONLY USE DOT 4 CLASS BRAKE FLUIDS. BRAKING CIRCUIT FLUIDS ARE HIGHLY CORROSIVE. MAKE SURE THAT IT DOES NOT COME INTO CONTACT WITH THE PAINTWORK**

.

#### CAUTION



**AVOID CONTACT OF BRAKE FLUID WITH EYES, SKIN, AND CLOTHING. IN CASE OF CONTACT, RINSE WITH WATER. THE BRAKING CIRCUIT FLUID IS HYGROSCOPIC, THAT IS, IT ABSORBS HUMIDITY FROM THE SURROUNDING AIR. IF THE HUMIDITY IN THE BRAKING FLUID EXCEEDS A CERTAIN VALUE,**



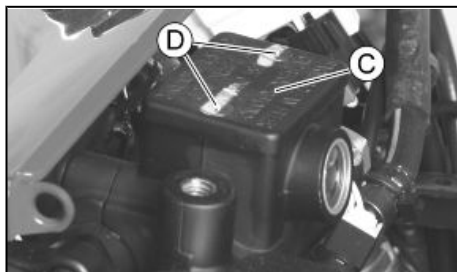

03\_20

**IT WILL LEAD TO INEFFICIENT BRAKING. NEVER USE BRAKING FLUID KEPT IN CONTAINERS THAT HAVE ALREADY BEEN OPENED, OR PARTIALLY USED.**

### Recommended products

#### **AGIP BRAKE 4**

*Brake fluid*  
FMVSS DOT 4 Synthetic fluid

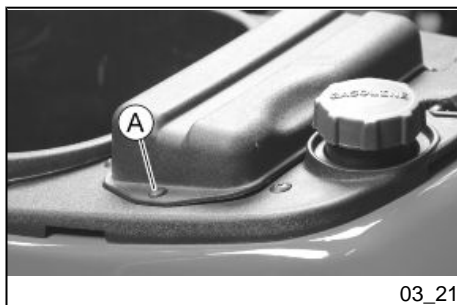

03\_21

### **Battery (03\_21)**

To access the battery, tilt the saddle forwards, then remove the battery compartment access door by unscrewing the star-shaped screw "A" shown in the figure.

The battery is the electrical device that requires the most frequent attention and the most thorough maintenance.

#### **WARNING**



**USED BATTERIES ARE HARMFUL FOR THE ENVIRONMENT. COLLECTION AND DISPOSAL SHOULD BE CARRIED OUT IN COMPLIANCE WITH REGULATIONS IN FORCE.**

#### **CAUTION**

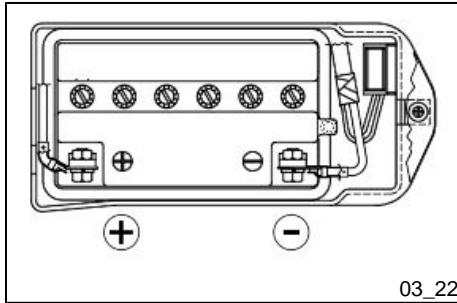

**ELECTROLYTE CONTAINS SULPHURIC ACID: AVOID CONTACT WITH EYES, SKIN AND CLOTHES. IN CASE OF ACCIDENTAL CONTACT, RINSE WITH ABUNDANT WATER AND CONSULT A DOCTOR.**

**CAUTION**

**IN ORDER TO AVOID DAMAGING THE ELECTRIC SYSTEM, NEVER DISCONNECT THE WIRING WHILE THE ENGINE IS RUNNING. DO NOT TIP THE VEHICLE TOO MUCH IN ORDER TO AVOID DANGEROUS LEAKAGE OF THE BATTERY ELECTROLYTE**

**Use of a new battery (03\_22)**

To install a new battery:

1. Place the battery in its housing.
2. Connect the positive pole «+» first and then the negative pole «-».
3. Place the battery cover.

**CAUTION**

**DO NOT REVERSE THE POLARITY: RISK OF SHORT CIRCUIT AND DAMAGE TO THE ELECTRICAL SYSTEM.**

**WARNING**

**USED BATTERIES ARE HARMFUL FOR THE ENVIRONMENT. COLLECTION AND DISPOSAL SHOULD BE CARRIED OUT IN COMPLIANCE WITH REGULATIONS IN FORCE.**

## Characteristic

### Battery

12V-9Ah

### Long periods of inactivity

Battery performance will decrease if the vehicle is not used for a long time. This is the result of the natural phenomenon of battery discharging, and may be due to residual absorption by vehicle components with constant power consumption. Poor battery performance may also be due to environmental conditions and the cleanness of the poles. In order to avoid difficult starts and/or irreversible damage to the battery, follow any of these steps:

- **At least once a month** start the engine and run it slightly above idle speed for 10-15 minutes. This keeps all the engine components, as well as the battery, in good working order.
- Take your vehicle to a garage (as indicated in the «Vehicle not used for extended periods» section) to have the battery removed. Have the battery cleaned, charged fully and stored in a dry, ventilated place. Recharge **at least once every two months**.

#### **N.B.**

**THE BATTERY MUST BE CHARGED WITH A CURRENT EQUAL TO 1/10 OF THE RATED CAPACITY OF THE BATTERY AND FOR NOT LONGER THAN 10 HOURS. CONTACT AN AUTHORISED SERVICE CENTRE TO CARRY OUT THIS OPERATION SAFELY. WHEN REFITTING THE BATTERY MAKE SURE THE LEADS ARE CORRECTLY CONNECTED TO THE TERMINALS.**

**WARNING**

**DO NOT DISCONNECT THE BATTERY CABLES WITH THE ENGINE RUNNING, THIS CAN CAUSE IRREPARABLE DAMAGE TO THE VEHICLE'S ELECTRONIC CONTROL UNIT.**

**WARNING**

**USED BATTERIES ARE HARMFUL FOR THE ENVIRONMENT. COLLECTION AND DISPOSAL SHOULD BE CARRIED OUT IN COMPLIANCE WITH REGULATIONS IN FORCE.**



03\_23

**Fuses (03\_23, 03\_24, 03\_25, 03\_26, 03\_27, 03\_28)****N.B.**

**TO ACCESS THE FRONT FUSES REMOVE THE FRONT LUGGAGE RACK BY UNSCREWING THE INDICATED SCREWS.**

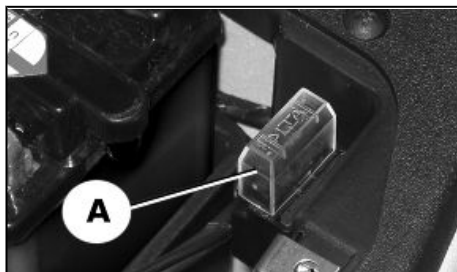

03\_24

The electrical system is protected by a fuse valve «A» located to the left of the battery support and two fuse valves «B» and «C» inside the front shield.

To reach it

1. Remove the clip-on badge «D».
2. Unscrew the screw «E».
3. Turn the handlebar completely to one side. Push the steering column cover up and pull to release the retaining tongues.

The front headlight and rear taillight are not protected by fuses.

Before replacing a blown fuse, find and solve the problem that caused it to blow. Do not replace the fuse with any alternative form of conductor

#### CAUTION



**IN ORDER TO AVOID DAMAGING THE ELECTRIC SYSTEM, NEVER DISCONNECT THE WIRING WHILE THE ENGINE IS RUNNING. DO NOT TIP THE VEHICLE TOO MUCH IN ORDER TO AVOID DANGEROUS LEAKAGE OF THE BATTERY ELECTROLYTE**

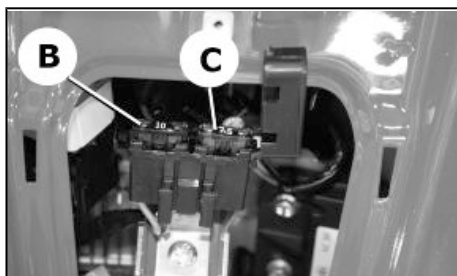

03\_25

#### CAUTION



**PERFORM THE OPERATIONS CAREFULLY.**

**DO NOT DAMAGE THE TONGUES OR THEIR SEATS. HANDLE THE PAINTED AND PLASTIC COMPONENTS CAREFULLY. DO NOT SCRATCH OR DAMAGE THEM.**



03\_26

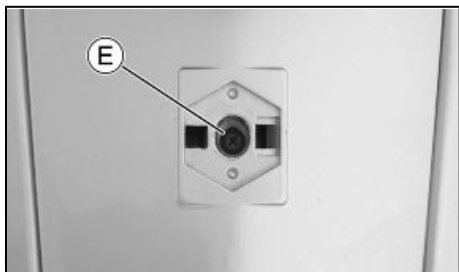

03\_27



03\_28

## **FUSES**

FUSE A	15 A - General
FUSE B	10 A - Electronic ignition device
FUSE C	7.5 A - fuel gauge, horn, stop light, starter button.

**BULBS**

High/low beam light bulb

**Type:** Spherical**Power:** 12V 35/35W**Quantity:** 1

Front side light bulb

**Type:** All glass**Power:** 12V 5W**Quantity:** 1

Front turn indicator light bulb

**Type:** Spherical**Power:** 12V - 10W**Quantity:** 1 RHS + 1 LHS

Rear turn indicator light bulb

**Type:** SPHERICAL**Power:** 12V - 10W**Quantity:** 1 RHS + 1 LHS

Stop and tail light bulb

**Type:** Spherical**Power:** 12V 21/5W**Quantity:** 1

Instrument panel lighting bulbs

**Type:** All glass**Power:** 12V 1.2W**Quantity:** 3Warning light bulbs: turn indicators **Type:** All glass

**Power:** 12V - 2W

**Quantity:** 2

Warning light bulbs: lights, high-beam lights, fuel reserve

**Type:** All glass

**Power:** 12V 1.2W

**Quantity:** 3

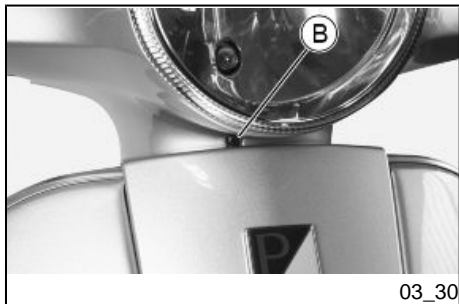

### Front light group (03\_29, 03\_30, 03\_31, 03\_32, 03\_33)

To access the headlight bulbs, remove the front of the handlebar cover, as follows:

1. Remove the rear-view mirrors.
2. Undo the three screws holding the handlebar cover, the two rear screws «A» and the front screw «B». Once this has been done, the front handlebar cover can be removed.

To replace the high-/low-beam headlight bulb:

1. Remove the rubber protection «C».
2. Unscrew the ring nut «D» to extract the bulb holder.
3. Press the bulb slightly and turn it anticlockwise to remove it.

To replace the tail light bulb:

1. Slide off the rubber bulb holder «E» from its fitting.
2. Hold and slide off the bulb.

**N.B.**

**IF MISTING IS NOTICED ON THE INSIDE OF THE HEADLAMP GLASS, THIS DOES NOT INDICATE A FAULT AND IS ATTRIBUTABLE TO HUMIDITY AND/OR TO LOW TEMPERATURES.**



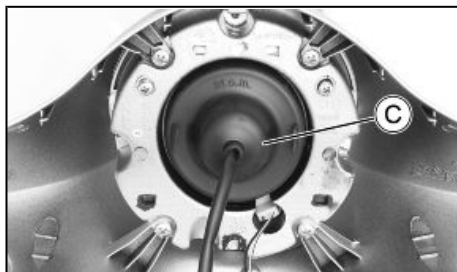

03\_31

THE PHENOMENON SHOULD QUICKLY DISAPPEAR WHEN THE LIGHT IS SWITCHED ON.

THE PRESENCE OF DROPS OF WATER, ON THE OTHER HAND, COULD INDICATE THAT WATER IS INFILTRATING. CONTACT THE AFTER-SALES SERVICE NETWORK.

**CAUTION**



DO NOT CARRY ANY GARMENTS ON THE FRONT HEADLIGHT ASSEMBLY. THIS MAY CAUSE BULBS TO OVERHEAT AND THEREFORE ABNORMAL WEAR.

**CAUTION**



PERFORM THE OPERATIONS CAREFULLY.

DO NOT DAMAGE THE TONGUES OR THEIR SEATS. HANDLE THE PAINTED AND PLASTIC COMPONENTS CAREFULLY. DO NOT SCRATCH OR DAMAGE THEM.

**CAUTION**



DO NOT PULL THE ELECTRICAL WIRING TO EXTRACT THE BULB HOLDER.



03\_32



03\_33

## **FRONT HEADLIGHT ASSEMBLY BULBS**

High/low beam light bulb	<b>Type:</b> Spherical <b>Power:</b> 12V 35/35W <b>Quantity:</b> 1
--------------------------	--

Front side light bulb	<b>Type:</b> All glass <b>Power:</b> 12V 5W <b>Quantity:</b> 1
-----------------------	--

### **Headlight adjustment (03\_34, 03\_35)**

Proceed as follows:

1. Place the vehicle in running order and with the tyres inflated to the prescribed pressure, on a flat surface 10 m away from a white screen situated in a shaded area, making sure that the longitudinal axis of the vehicle is perpendicular to the screen;
2. Turn on the headlight and check that the borderline of the projected light beam on the screen is no higher than 9/10 or lower than 7/10 of the distance from the ground to the centre of the vehicle's headlamp;
3. If otherwise, adjust the right headlight with screw «A».

#### **N.B.**

**THE ABOVE PROCEDURE COMPLIES WITH THE EUROPEAN STANDARDS REGARDING MAXIMUM AND MINIMUM HEIGHT OF LIGHT BEAMS. REFER TO THE STATUTORY REGULATIONS IN FORCE IN EVERY COUNTRY WHERE THE VEHICLE IS USED.**

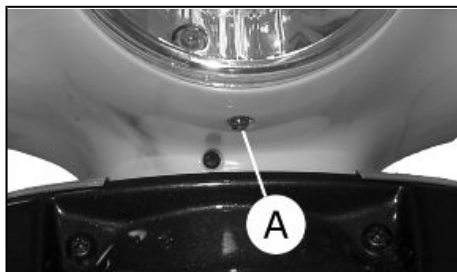

03\_34

**CAUTION**

**DO NOT CARRY ANY GARMENTS ON THE FRONT HEADLIGHT ASSEMBLY. THIS MAY CAUSE BULBS TO OVERHEAT AND THEREFORE ABNORMAL WEAR.**

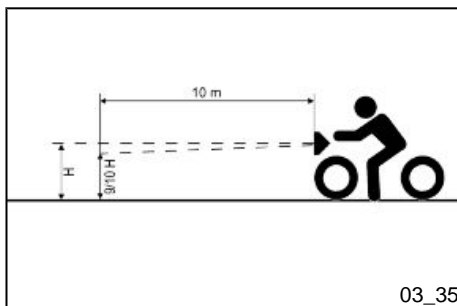

03\_35

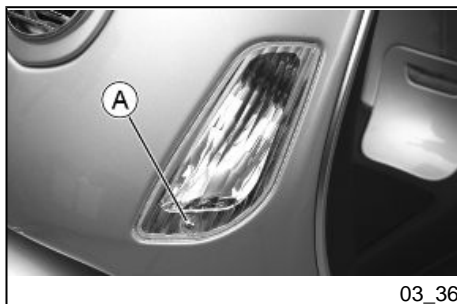

03\_36

**Front direction indicators (03\_36, 03\_37)**

To replace the bulbs:

1. Remove the turn indicator from its fitting by undoing the screw «A».
2. Take out the bulb holder «B» from its fitting by turning it anticlockwise.
3. Press the bulb, turn it anticlockwise and then take it out.

To refit, proceed in reverse order.

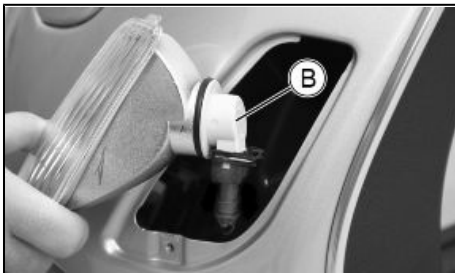

03\_37

### **FRONT TURN INDICATOR BULBS**

Front turn indicator light bulb

**Type:** Spherical

**Power:** 12V - 10W

**Quantity:** 1 RHS + 1 LHS

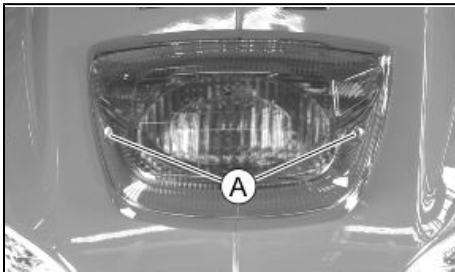

03\_38

### **Rear optical unit (03\_38, 03\_39)**

To replace the taillight bulb:

1. Remove the two screws «A».
2. Take out the bulb holder «B» from its fitting by turning it anticlockwise.
3. Press the bulb, turn it anticlockwise and then take it out.

To refit, proceed in reverse order.

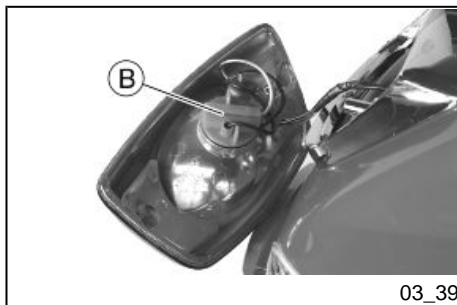

03\_39

**N.B.**

IF MISTING IS NOTICED ON THE INSIDE OF THE HEADLAMP GLASS, THIS DOES NOT INDICATE A FAULT AND IS ATTRIBUTABLE TO HUMIDITY AND/OR TO LOW TEMPERATURES.

THE PHENOMENON SHOULD QUICKLY DISAPPEAR WHEN THE LIGHT IS SWITCHED ON.

THE PRESENCE OF DROPS OF WATER, ON THE OTHER HAND, COULD INDICATE THAT WATER IS INFILTRATING. CONTACT THE AFTER-SALES SERVICE NETWORK.

### REAR LIGHT UNIT BULBS

Stop and tail light bulb

**Type:** Spherical

**Power:** 12V 21/5W

**Quantity:** 1



03\_40

### **Rear turn indicators (03\_40, 03\_41)**

To replace the bulbs:

1. Remove the turn indicator from its fitting by undoing the screw «A».
2. Take out the bulb holder «B» from its fitting by turning it anticlockwise.
3. Press the bulb, turn it anticlockwise and then take it out.

To refit, proceed in reverse order.

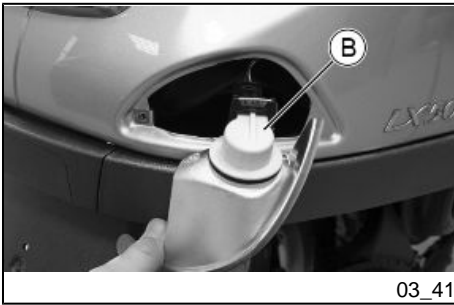

### **REAR TURN INDICATOR BULBS**

Rear turn indicator light bulb

**Type:** SPHERICAL

**Power:** 12V - 10W

**Quantity:** 1 RHS + 1 LHS

### **Rear-view mirrors (03\_42)**

The mirrors can be set to the desired position by adjusting the mirror frame.

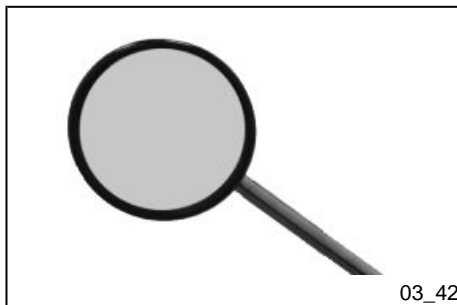

To remove the rear-view mirror rotate the rear-view mirror support rod clockwise.

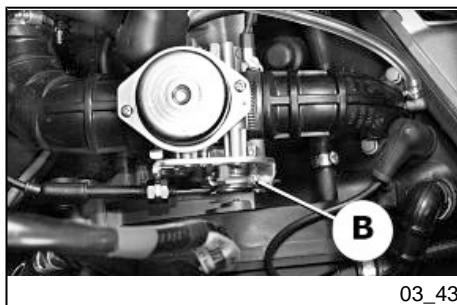

### Idle adjustment (03\_43)

Proceed as follows:

1. Rest the vehicle on its centre stand and lift the saddle (as described in the «Saddle opening» section).
2. Remove the helmet compartment.
3. To adjust the idle speed, start the engine, then loose or tighten the screw «B» until you reach the recommended idle speed taking care the engine does not make the rear wheel move.

If it is difficult to adjust idle speed, take your vehicle to an **Authorised Dealer or Service Centre**.

#### WARNING



**ADJUST IDLE SPEED WHEN THE ENGINE IS FAIRLY HOT AND HAS BEEN RUNNING FOR AT LEAST FIVE MINUTES. BEFORE THIS OPERATION, MAKE SURE THAT THE THROTTLE GRIP HAS THE RECOMMENDED BACKLASH. IF BACKLASH IN THE THROTTLE CONTROL TRANSMISSION NEEDS ADJUSTING TAKE YOUR SCOOTER TO AN AUTHORISED DEALER OR SERVICE CENTRE.**



## Characteristic

### Engine idle speed

1700 ÷ 1900

### Front disc brake (03\_44)

The brake disc and pad wear is automatically compensated, therefore it has no effect on the functioning of the front and rear brakes. For this reason it is not necessary to adjust the brakes. An excessively elastic brake lever stroke may indicate the presence of air in the braking circuit or a failure in the braking system. In this case, mainly due to the importance of brakes to guarantee safe riding conditions, the vehicle should be taken to an **Authorised Service Centre or Dealer**.

#### CAUTION



**BRAKING SHOULD BEGIN AFTER ABOUT 1/3 OF THE BRAKE LEVER STROKE.**

#### CAUTION



**HAVE THE BRAKE PADS CHECKED BY THE DEALER ACCORDING TO THE CHECKS SPECIFIED IN THE SCHEDULED MAINTENANCE TABLE. HOWEVER, IN THE EVENT OF NOISES COMING FROM THE FRONT AND/OR REAR BRAKING SYSTEM DURING OPERATION, IT IS ADVISABLE TO HAVE THE BRAKING SYSTEM CHECKED BY AN AUTHORISED SERVICE CENTRE OR DEALER. AFTER REPLACING THE BRAKE PADS, DO NOT USE THE SCOOTER UNTIL YOU HAVE OPERATED THE BRAKE LEVER SEVERAL TIMES IN ORDER TO ALLOW THE PLUNGERS TO SETTLE AND THE LEVER STROKE TO BE SET TO THE CORRECT POSITION.**



**CAUTION**

THE PRESENCE OF SAND, MUD, SNOW MIXED WITH SALT, ETC. ON THE ROAD, CAN DRASTICALLY REDUCE THE LIFE OF THE BRAKE PADS. IN ORDER TO AVOID THIS, WE RECOMMEND WASHING THE VEHICLE FREQUENTLY WHEN RIDING IN THESE ROAD CONDITIONS.

**Rear drum brake (03\_45)**

Operate adjusting nut «B» and loosen lock nut «A» shown in the figure. Note that when the throttle is in idle **the wheel should rotate free**. After the adjustment, screw lock nut «A».

**CAUTION**

**BRAKING SHOULD BEGIN AFTER ABOUT 1/3 OF THE BRAKE LEVER STROKE.**

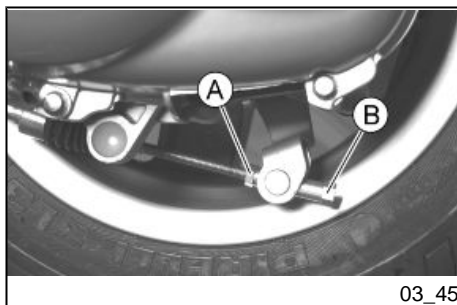
**Puncture**

The vehicle is equipped with Tubeless tyres (without inner tube). In the event of a puncture, Tubeless tyres - unlike tyres with inner tubes - go flat very slowly, resulting in a greater steering safety. In the event of a puncture, an emergency repair can be carried out using an "inflate and repair" spray can. For a final repair, take your vehicle to an **Authorised Service Centre or Dealer**. The replacement of a tyre involves removing the wheel in question. Take your vehicle to an **Authorised Service Centre or Dealer** for these operations.

**CAUTION**

TO USE THE "INFLATE AND REPAIR" SPRAY CAN PROPERLY, FOLLOW THE INSTRUCTIONS ON THE PACKAGING.

**WARNING**

THE WHEELS FITTED WITH TYRES SHOULD ALWAYS BE BALANCED. RIDING THE VEHICLE WITH VERY LOW TYRE PRESSURE OR WITH INCORRECTLY BALANCED TYRES CAN LEAD TO DANGEROUS STEERING VIBRATIONS.



03\_46

**Periods of inactivity (03\_46)**

We recommend carrying out the following operations:

1. General cleaning of the vehicle.
2. With the engine off and the piston at the bottom dead centre position, **remove the spark plug**, and pour 1 ÷ 2 cm<sup>3</sup> of recommended oil through its opening. Press the engine start pedal 3 or 4 times letting the engine perform a few revolutions slowly, then replace the spark plug.
3. Drain off all the vehicle fuel; spread antirust grease on the unpainted metal parts; keep the wheels off the ground, by resting the chassis on two wooden wedges.
4. For the battery, follow the procedures described in the «Battery» section.
5. Drain the petrol from the carburettor float chamber through the bleed cap.

**Recommended products****AGIP CITY HI TEC 4T**

*Oil to lubricate flexible transmissions (brake, throttle control and mixer, odometer).*

Synthetic oil for SAE 5W-40, API SL, ACEA A3, JASO MA engines

## Cleaning the vehicle

Use a low pressure jet of water to soften the caked dirt and mud deposited on the painted surfaces. Once softened, sponge off mud and dirt using a car body sponge soaked in a car body shampoo and water solution (2-4% of car shampoo in water). Then rinse with abundant water, and dry with a shammy cloth. For the engine exterior, use petrol, a brush and clean cloths. Petrol can damage paintwork. Remember that any polishing with silicone wax must always be preceded by washing.

### WARNING



**To avoid the appearance of oxidations, wash the vehicle every time it is used in certain areas or in special conditions of:**

- **Environmental / seasonal conditions: use of salt, de-icer chemical products on the road in winter.**
- **Air pollution: city and/or industrial areas.**
- **Salinity and humidity of the atmosphere: marine areas, hot and wet weather.**

### WARNING



- **Avoid that deposits remain on the bodywork, industrial and pollutant residual dust, tar spots, dead insects, bird droppings, etc.**
- **Do not park the vehicle under the trees. In some seasons, as from the trees may fall residues, resins, fruits or leaves that contain chemicals which are harmful to the paintwork.**

**CAUTION**

**DETERGENTS POLLUTE WATER. THEREFORE THE VEHICLE SHOULD BE WASHED IN AN AREA EQUIPPED FOR THE COLLECTION AND PURIFICATION OF THE LIQUIDS USED.**

**WARNING**

**NEVER WASH THE VEHICLE UNDER DIRECT SUNLIGHT, ESPECIALLY IN SUMMER WHEN THE BODYWORK IS STILL HOT, AS THE CAR SHAMPOO MAY DRY BEFORE BEING RINSED OFF, AND COULD DAMAGE THE PAINTWORK. NEVER USE RAGS SOAKED IN PETROL OR DIESEL OIL TO CLEAN THE PAINTED OR PLASTIC SURFACES, TO PREVENT THEM LOSING THEIR SHINE AND MECHANICAL CHARACTERISTICS.**

**WARNING**

**WHEN WASHING THE ENGINE WITH A HIGH-PRESSURE WATER JET:**

- **ONLY USE FAN SPRAY JETS.**
- **DO NOT PLACE THE NOZZLE CLOSER THAN 60 CM.**
- **DO NOT USE WATER AT TEMPERATURES OVER 40° C.**
- **DO NOT DIRECT THE JETS DIRECTLY TO CARBURETTOR, WIRINGS, SLOT DIFFUSERS ON THE TRANSMISSION COVER AND SCROLL COVER.**

## START-UP PROBLEMS

No fuel in tank	Refuel
Filters, jets or carburettor body dirty or clogged.	Contact an <b>Authorised Service Centre.</b>
Insufficient battery charge	Kick-start. Recharge the battery.

## IGNITION PROBLEMS

No spark from spark plug. Due to the presence of high voltage, this check should only be carried out by an expert.	Make sure the electrodes are properly adjusted. Check that they are (clean with pure petrol and a metal brush or with emery cloth). Check the spark plug insulator: Replace the spark plug if the insulator is cracked or broken. If the spark plug is in good conditions, contact an <b>Authorised Service Centre.</b>
--	--

## LACK OF COMPRESSION

Spark plug loose. Loose cylinder head, worn piston retaining rings.	Contact an <b>Authorised Service Centre.</b>
---	--

## **HIGH CONSUMPTION AND LOW PERFORMANCE**

Air filter blocked or dirty.	Clean with water and shampoo and impregnate with petrol and specific oil («Air filter removal» section)
------------------------------	---

## **INEFFICIENT BRAKING**

Oil on drum or disc. Worn Pads/ Shoes	Contact an <b>Authorised Service Centre</b>
incorrect rear brake adjustment	Adjust

## **INEFFICIENT SUSPENSION**

Oil leak; worn limit switch bumpers; worn shock absorber attachment points	Contact an <b>Authorised Service Centre</b>
--	---

## **AUTOMATIC TRANSMISSION PROBLEMS**

Deteriorated roller housing or belt.	Contact an <b>Authorised Service Centre.</b>
--------------------------------------	--

**INCREASED EXHAUST NOISE**

Deterioration of the SAS system and/or of the tab	Contact an <b>Authorised Service Centre</b> .
---	---

**STAND DOES NOT RETURN TO POSITION**

Presence of dirt	Clean and grease
------------------	------------------

**STARTER LEVER DOES NOT RETURN TO CORRECT POSITION**

Presence of dirt	Clean and grease
------------------	------------------





# Vespa LX 50 4v Touring

**Vespa®**



**Chap. 04**  
**Technical data**

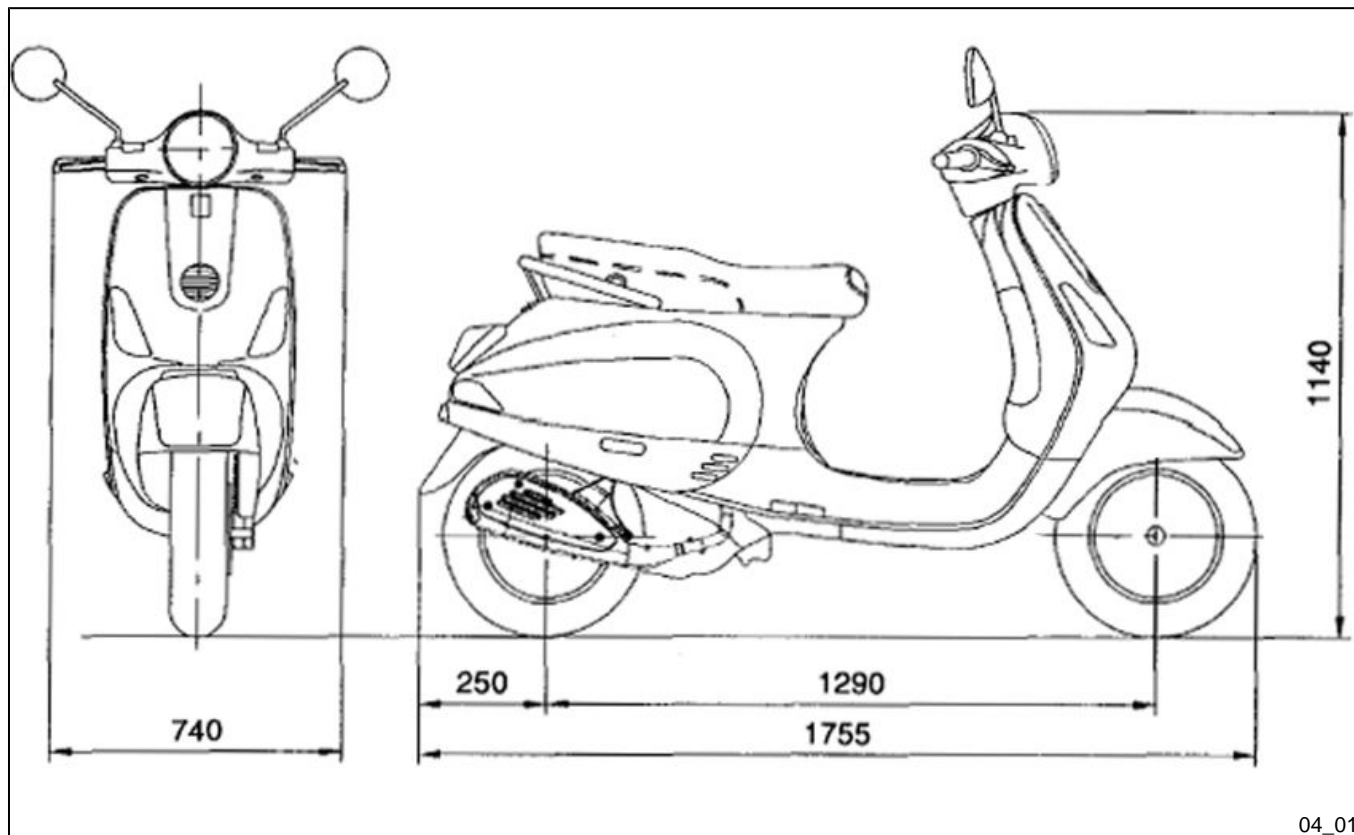

**ENGINE TECHNICAL DATA**

Type	single-cylinder, four-stroke and four-valve, air-cooled engine
Bore	39 mm
Stroke	41.8 mm
Cubic capacity	49,9 cm <sup>3</sup>
MAX Power	3.2 kW at 8250 rpm
MAX torque	3.8 Nm at 7750 rpm
Compression ratio	11.5 - 12.5 1
Timing system	single overhead camshaft, controlled by a chain on the left-hand side, three-arm rocking levers and pads calibrated for valve clearance adjustment.
Engine idle speed	1700 ÷ 1900
Starting system	electric starter/kick starter
Lubrication	engine lubrication with lobe pump (in the crankcase), chain-driven. Mesh pre-filter and centrifugal filter on the crankshaft
Fuel system	Gravity feed, with unleaded petrol (with a minimum octane rating of 95) with carburettor.
Valve clearance (cold engine)	intake 0.10 mm discharge 0.15 mm

CARBURETTOR	vacuum KEIHIN NCV $\varnothing$ 20 with electronic control of carburation (SIS)
Cooling	forced air circulation
Transmission	Automatic expandable pulley variator with torque server, V-belt, automatic centrifugal dry clutch.
Final reduction gear	Gear reduction unit in oil bath.
Ignition	Electronic inductive discharge ignition, with variable advance and separate HV coil.
Ignition	Starter and kick starter
Spark plug	NGK ER9EH-6N
Alternative spark plug	-
Electrode gap	0.5 $\div$ 0.6 mm

### **VEHICLE TECHNICAL DATA**

Chassis	Stamped plate body with welded structural reinforcements.
Front suspension	Single arm with helical spring and single double-acting hydraulic shock absorber.
Rear suspension	Single-chamber shock absorber.
Front brake	$\varnothing$ 200-mm disc brake with hydraulic control activated by handlebar right-side lever.

Rear brake	Ø 110-mm drum brake with mechanical control activated by handlebar left-side lever.
Wheel rim type	Light alloy wheel rims.
Front wheel rim	11" x 2.50
Rear wheel rim	10" x 3.00
Front tyre	Tubeless, 110/70 - 11" 45L
Rear tyre	Tubeless, 120/70 - 10" 54L
Front tyre pressure (with passenger)	1.6 bar (1.6 bar)
Rear tyre pressure (with passenger)	2.0 bar (2.3 bar)
Kerb weight	102 ± 5 kg
Maximum weight allowed	290 kg
Battery	12V/9 Ah

### **CAPACITY**

Engine oil	~ 850 cm <sup>3</sup>
Transmission oil	80 cm <sup>3</sup>
Fuel tank (reserve)	~ 8.5 l (2 l)

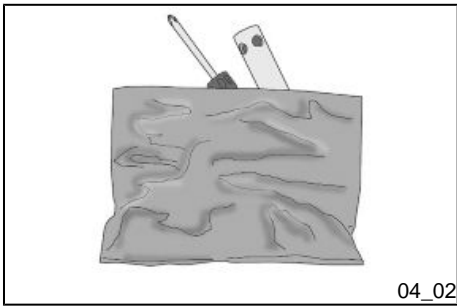

04\_02

### Toolkit (04\_02)

The toolkit comprises:

- One box-spanner.
- One twin screwdriver.

The tools are stored under the saddle.

# Vespa LX 50 4v Touring

**Vespa®**



**Chap. 05  
Spare parts and  
accessories**



## Warnings (05\_01)

### WARNING



IT IS RECOMMENDED THAT "ORIGINAL PIAGGIO SPARE PARTS" BE USED, AS THESE ARE THE ONLY ONES OFFERING YOU THE SAME QUALITY ASSURANCE AS THOSE INITIALLY FITTED ON THE VEHICLE.

IT SHOULD BE REMEMBERED THAT USING NON-ORIGINAL SPARE PARTS CAUSES YOUR WARRANTY RIGHTS TO EXPIRE.

### WARNING



PIAGGIO MARKETS ITS OWN LINE OF ACCESSORIES THAT ARE RECOGNISED AND GUARANTEED FOR USE. IT IS THEREFORE ESSENTIAL TO CONTACT AN AUTHORISED DEALER OR SERVICE CENTRE IN ORDER TO CHOOSE AND FIT ACCESSORIES CORRECTLY. THE USE OF NON-ORIGINAL ACCESSORIES MAY AFFECT THE STABILITY AND OPERATION OF YOUR VEHICLE AND REDUCE SAFETY LEVELS WITH POTENTIAL RISKS FOR THE RIDER.



# Vespa LX 50 4v Touring

**Vespa®**



**Chap. 06  
Scheduled  
maintenance**



## Scheduled servicing table (06\_01)

Adequate maintenance is fundamental to ensuring long-lasting, optimum operation and performance of your vehicle.

To this end, a series of checks and maintenance operations (at the owner's expense) have been suggested, which are included in the summary table on the following page. Any minor faults should be reported without delay to an **Authorised Service Centre or Dealer** without waiting until the next scheduled service to solve it.

It is indispensable to have your vehicle serviced to the prescribed intervals of time, even if you have not reached the predicted mileage. Punctual vehicle servicing is necessary for the correct use of the guarantee. For all further information regarding the Guarantee application modes and the execution of the "Programmed Maintenance" refer to the "Guarantee Booklet".

### SCHEDULED MAINTENANCE TABLE

Km x 1000	1	3	6	9	12	15	18	21	24	27	30	33	36	39	42	45	48	51	54	57	60		
Safety locks	I				I				I				I				I					I	
Spark plug			R		R		R		R		R		R		R		R		R		R		R
Drive belt			I		R		I		R		I		R		I		R		I		R		R
Throttle control	A				A				A				A				A						A
Tyre condition and wear					I				I				I				I						I
Air filter					C				C				C				C						C
Oil filter (mesh)			C		C		C		C		C		C		C		C		C		C		C
Solenoid filter			C		C		C		C		C		C		C		C		C		C		C
Valve clearance	I				I				I				I				I						I

Km x 1000	1	3	6	9	12	15	18	21	24	27	30	33	36	39	42	45	48	51	54	57	60
Electrical system and battery	I		I		I		I		I		I		I		I		I		I		I
Cylinder ventilation system									I								I				
Brake levers	L				L				L				L				L				L
Brake oil level (*)	I		I		I		I		I		I		I		I		I		I		I
Hub oil level	R		I		R		I		R		I		R		I		R		I		R
Engine oil	R	I	R	I	R	I	R	I	R	I	R	I	R	I	R	I	R	I	R	I	R
Brake Pads/Shoes	I		I		I		I		I		I		I		I		I		I		I
Tyre pressure	I		I		I		I		I		I		I		I		I		I		I
Headlight					A				A				A				A				A
Vehicle road test	I		I		I		I		I		I		I		I		I		I		I
Idle speed	A				A				A				A				A				A
Odometer gear					L				L				L				L				L
CVT rollers			I		R		I		R		I		R		I		R		I		R
Suspension					I				I				I				I				I
Steering	A				A				A				A				A				A
Transmission					L				L				L				L				L

*I: CHECK AND CLEAN, ADJUST, LUBRICATE OR REPLACE IF NECESSARY.*

*C: CLEAN, R: REPLACE, A: ADJUST, L: LUBRICATE*

*\* Replace every 2 years*

## RECOMMENDED PRODUCTS TABLE

Product	Description	Specifications
AGIP ROTRA 80W-90	Rear hub oil	SAE 80W/90 Oil that exceeds the requirements of API GL3 specifications
AGIP BRAKE 4	Brake fluid	FMVSS DOT 4 Synthetic fluid
AGIP CITY HI TEC 4T	Oil to lubricate flexible transmissions (brakes, throttle control and odometer)	Oil for 4-stroke engines
AGIP FILTER OIL	Oil for air filter sponge	Mineral oil with specific additives for increased adhesiveness
AGIP CITY HI TEC 4T	Engine oil	SAE 5W-40, API SL, ACEA A3, JASO MA Synthetic oil
AGIP GREASE MU3	Grease for odometer transmission gear case	Soap-based lithium grease with NLGI 3; ISO-L-XBCHA3, DIN K3K-20
AGIP GP 330	Grease for brake levers, throttle, stand	White calcium complex soap-based spray grease with NLGI 2; ISO-L-XBCIB2

# TABLE OF CONTENTS

## **A**

Air filter: 37

## **B**

Battery: 41, 42  
Brake: 39, 56, 57

## **C**

Checks: 20  
Clock: 11

## **D**

Disc brake: 56

## **E**

Engine oil: 32, 33

## **F**

Fuel: 15  
Fuses: 44

## **H**

Headlight: 50  
Horn: 14  
Hub oil: 34

## **I**

Identification: 16  
Instrument panel: 10

## **K**

Key switch: 12  
Keys: 16

## **L**

Light switch: 14

## **M**

Maintenance: 31, 73  
Mirrors: 54

## **P**

Puncture: 57

## **R**

Refuelling: 20

## **S**

Saddle: 16  
Scheduled maintenance: 73  
Spark plug: 36  
Stand: 27  
Start-up: 15  
Switch: 12–14

## **T**

Tank: 15  
Technical Data: 65  
Toolkit: 70  
Top box: 18  
Transmission: 27  
Turn indicators: 53  
Tyre pressure: 21  
Tyres: 35

## **V**

Vehicle: 7, 59



The descriptions and illustrations given in this publication are not binding. While the basic specifications as described and illustrated in this manual remain unchanged, PIAGGIO-GILERA reserves the right, at any time and without being required to update this publication beforehand, to make any changes to components, parts or accessories, which it considers necessary to improve the product or which are required for manufacturing or construction reasons.

Not all versions/models shown in this publication are available in all countries. The availability of each model should be checked at the official Piaggio sales network.

"© Copyright 2008 - PIAGGIO & C. S.p.A. Pontedera. All rights reserved. Reproduction of this publication in whole or in part is prohibited."

PIAGGIO & C. S.p.A. - Aftersales

V.le Rinaldo Piaggio, 23 - 56025 PONTEDERA (Pi)