

Vespa would like to thank you

for choosing one of its products. We have prepared this manual to help you to get the very best from your scooter. Please read it carefully before riding the scooter for the first time. It contains information, tips and precautions for using your scooter. It also describes features, details and devices to assure you that you have made the right choice. We believe that if you follow our suggestions, you will soon get to know your new vehicle and it will serve you well for a long time to come. This booklet forms an integral part of the scooter; should the scooter be sold, it must be transferred to the new owner.

# Vespa LXV 125



The instructions given in this manual are intended to provide a clear, simple guide to using your scooter; this booklet also details routine maintenance procedures and regular checks that should be carried out on the vehicle at an **authorised Dealer or Service Centre**. The booklet also contains instructions for simple repairs. Any operations not specifically described in this manual require the use of special tools and/or particular technical knowledge: to carry out these operations refer to any **authorised Dealer of Service Centres**.



### **Personal safety**

Failure to completely observe these instructions will result in serious risk of personal injury.



### **Safeguarding the environment**

Sections marked with this symbol indicate the correct use of the vehicle to prevent damaging the environment.



### **Vehicle intactness**

The incomplete or non-observance of these regulations leads to the risk of serious damage to the vehicle and sometimes even the invalidity of the guarantee.

*The signs that you see on this page are very important. They are used to highlight those parts of the booklet that should be read with particular care. As you can see, each sign consists of a different graphic symbol, making it quick and easy to locate the various topics.*



# INDEX

<b>VEHICLE</b> .....	7	Engine oil level.....	30
Dashboard.....	9	Engine oil level check.....	30
Analogue instrument panel.....	10	Engine oil top-up.....	31
Key switch.....	11	Warning light (insufficient oil pressure).....	31
Locking the steering wheel.....	11	Engine oil change.....	31
Releasing the steering wheel.....	11	Hub oil level.....	32
Switch direction indicators.....	12	Tyres.....	34
Horn button.....	12	Spark plug dismantlement.....	35
Light switch.....	12	Removing the air filter.....	36
Start-up button.....	13	Secondary air system.....	37
Engine stop button.....	13	Checking the brake oil level.....	38
The immobilizer system.....	13	Battery.....	39
Keys.....	13	Checking the electrolyte level.....	40
Immobilizerdevice enabled indicator led.....	14	Long periods of inactivity.....	40
Operation.....	14	Fuses.....	41
Programming the immobilizer system.....	15	Front light group.....	44
The saddle.....	16	Headlight adjustment.....	44
Opening the saddle.....	17	Front direction indicators.....	45
Identification.....	17	Rear optical unit.....	46
Rear top box opening.....	18	Rear turn indicators.....	46
<b>USE</b> .....	19	Number plate light.....	47
Checks.....	20	Rear-view mirrors.....	47
Refuelling.....	20	Idle adjustment.....	48
Tyre pressure.....	21	Front disc brake.....	49
Shock absorbers adjustment.....	22	Rear drum brake.....	50
Running in.....	22	Puncture.....	50
Starting up the engine.....	23	Periods of inactivity.....	50
Precautions.....	24	Cleaning the vehicle.....	51
Difficult start up.....	25	<b>TECHNICAL DATA</b> .....	57
Stopping the engine.....	26	Kit equipment.....	60
Automatic transmission.....	26	<b>SPARE PARTS AND ACCESSORIES</b> .....	61
Safe driving.....	27	Warnings.....	62
<b>MAINTENANCE</b> .....	29	<b>PROGRAMMED MAINTENANCE</b> .....	63



# Vespa LXV 125

**Vespa®**



**Chap. 01  
Vehicle**

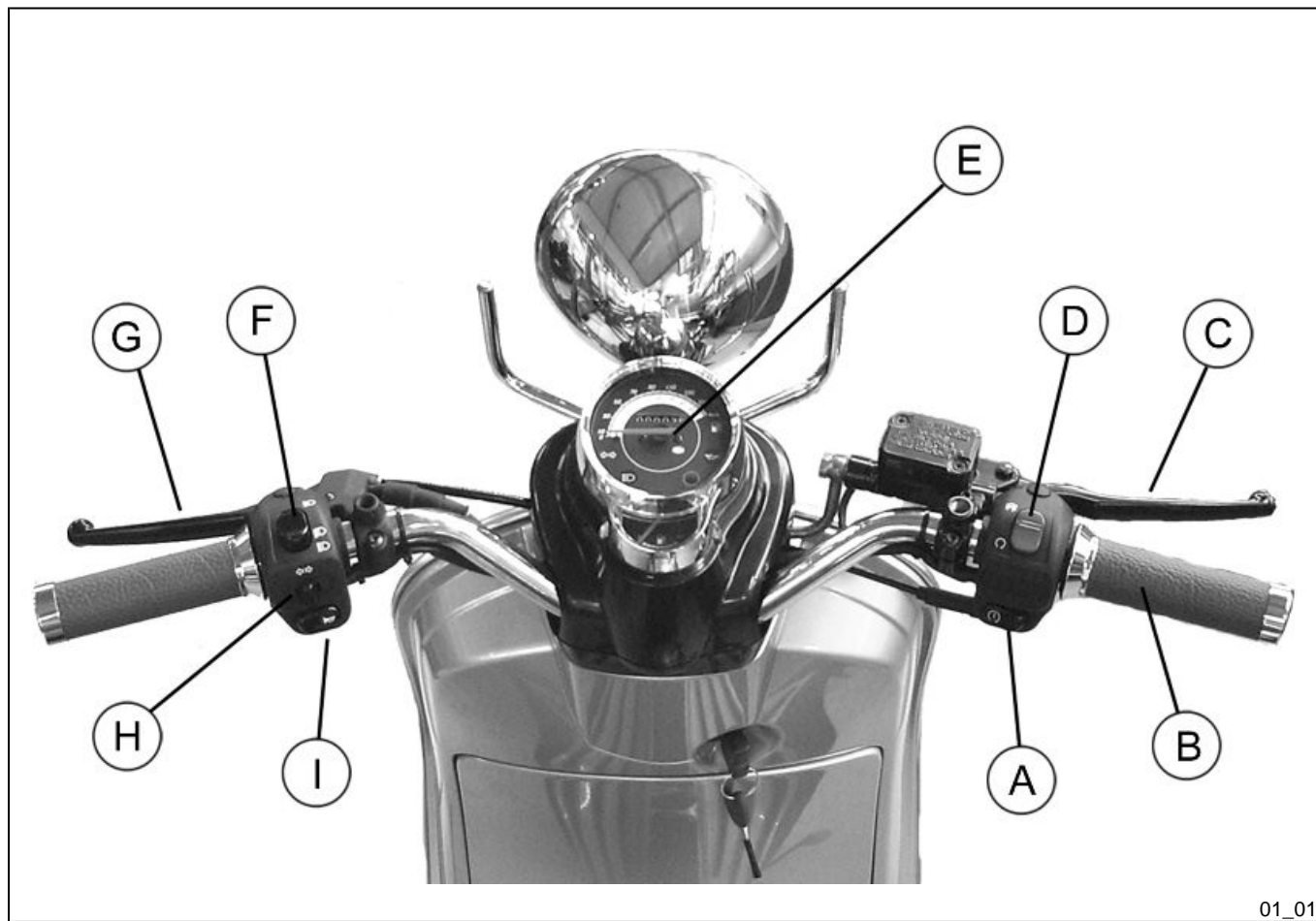



## **Dashboard (01\_01)**

**A** = Starter button

**B** = Throttle grip

**C** = Front brake lever

**D** = Run-Off switch

**E** = Instrument panel

**F** = Headlight switch

**G** = Rear brake lever

**H** = Turn indicator switch

**I** = Horn button

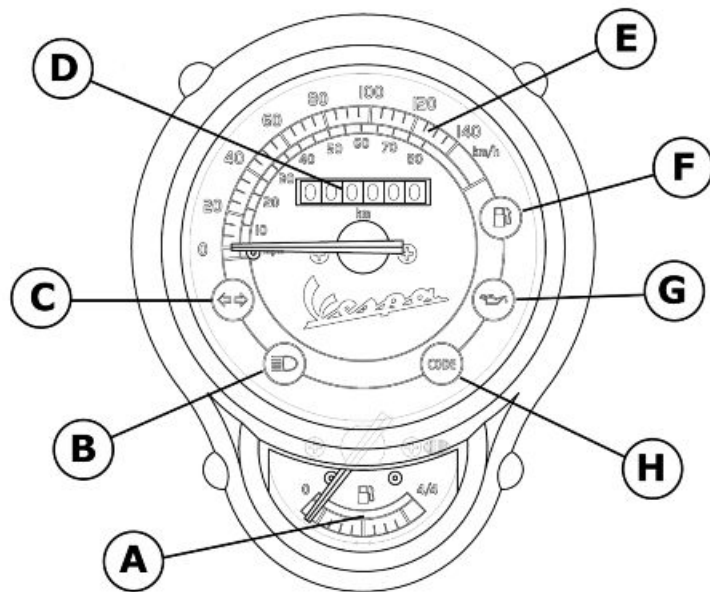

01\_02

### Analogue instrument panel (01\_02)

- A = Fuel gauge
- B = High-beam warning light
- C = Turn indicator warning light
- D = Odometer
- E = Speedometer
- F = Low fuel warning light

**G** = Low oil pressure warning light

**H** = Antitheft device led (IMMOBILIZER)

### Key switch (01\_03)

**LOCK** = Ignition disabled, extractable key, steering lock engaged front glove-box locked.

**OFF** = Ignition disabled, extractable key, steering lock disengaged, front glove-box unlocked.

**ON** = Starter position, antitheft device disabled, non-extractable key, glove-box unlocked.

### Locking the steering wheel

Turn the handlebar to the left (as far as it will go), turn the key to position «**LOCK**» and remove the key.

#### CAUTION



**DO NOT TURN THE KEY TO «LOCK» OR «OFF» WHILE RIDING.**

### Releasing the steering wheel

Reinsert the key and turn it to «**OFF**».

#### CAUTION



**DO NOT TURN THE KEY TO «LOCK» OR «OFF» WHILE RIDING.**



01\_03

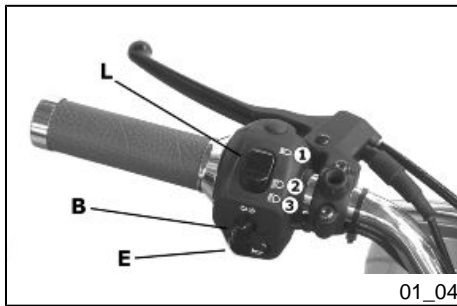

### Switch direction indicators (01\_04)

To set the left turn indicators flashing, move lever «**B**» to the left; to set the right turn indicators flashing, move it to the right. The lever automatically returns to the central position and the indicators remain on. To turn the indicators off, press the lever towards the switch.

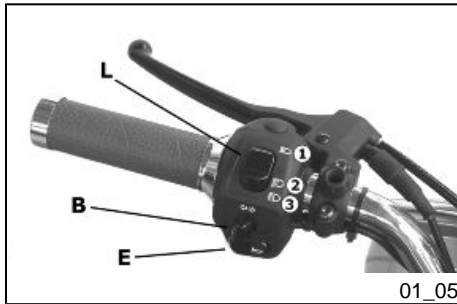

### Horn button (01\_05)

Horn button «**E**»

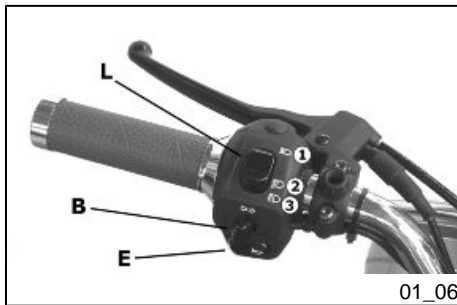

### Light switch (01\_06)

1 = High beam and side light

2 = Low beam and side light

3= High-beam light passing mode

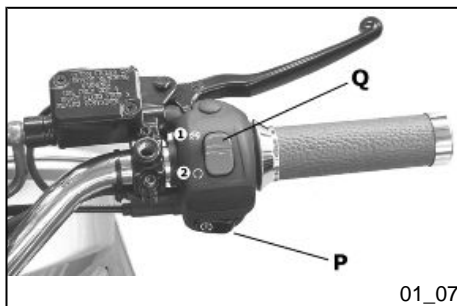

01\_07

### Start-up button (01\_07)

To start the engine, press the starter button, «P», after pulling either one of the two brake levers.

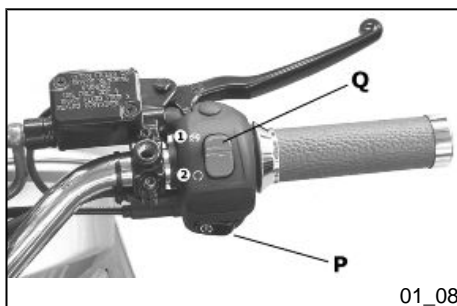

01\_08

### Engine stop button (01\_08)

Operation of engine stop switch «Q»:

1 = when in OFF, the engine stops.

2 = when in RUN, the engine can be started.

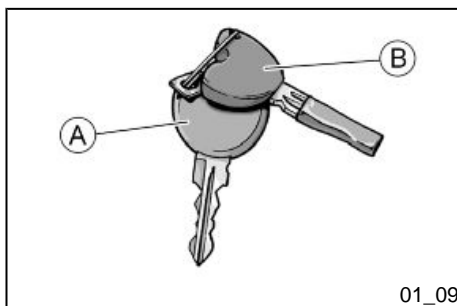

01\_09

### The immobilizer system

In order to enhance theft protection, the scooter is equipped with a «**PIAGGIO IMMOBILIZER**» electronic engine locking device that is activated automatically when the starter key is removed. Upon start-up, the «**PIAGGIO IMMOBILIZER**» system checks the starter key, and only if this key is recognised will the immobilizer system allow the scooter to be started.

### Keys (01\_09, 01\_10, 01\_11)

Two types of keys come with the vehicle. Key «A» with the brown grip is the «**MAS-TER**» key. Only a single copy of this key is supplied, which is necessary to program all your other keys and for your dealer to perform some maintenance operations. We

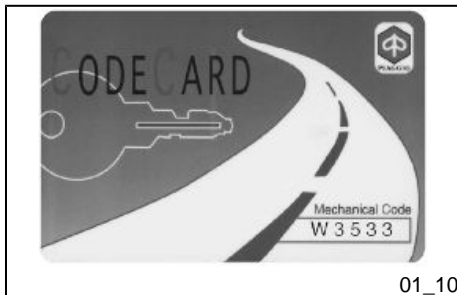

01\_10

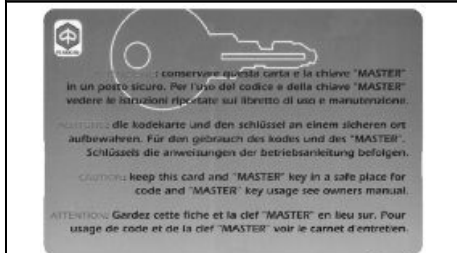

01\_11

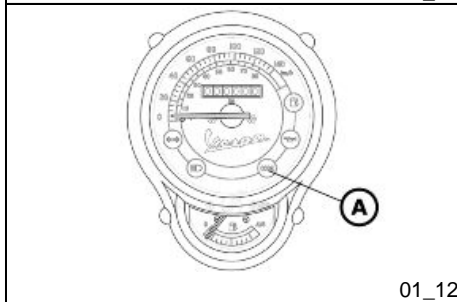

01\_12

therefore recommend that it be used only under exceptional circumstances. Black key «B» (single copy supplied) is used for normal use such as:

- start-up
- saddle opening
- glove box opening

Together with the keys, you will receive a **CODE CARD** bearing the same code imprinted onto the two keys.

#### WARNING



**THE LOSS OF THE BROWN KEY PREVENTS LATER REPAIRS TO THE "PIAGGIO IMMOBILIZER" SYSTEM AND TO THE ENGINE CONTROL UNIT.**

#### Immobilizerdevice enabled indicator led (01\_12)

The activation of the «PIAGGIO IMMOBILIZER» system is shown by the flashing of the appropriate warning light «A» (see «Instrument panel» section).

In order to reduce battery discharge, the indicator LED turns off automatically after 48 hours of uninterrupted functioning.

Should the system fail, different LED flashing patterns will be provided by an **Authorised Piaggio-Gilera Service Centre** with information on the type of fault detected.

#### Operation

Every time the starter key is removed in the "OFF" or "LOCK" position, the safety system activates the immobilizer system. Turning the key to "ON" disables the engine lock, provided that the safety system recognises the code transmitted by the key. If the code is not recognised, turn the key first to "OFF" and then to "ON"; if the lock cannot be disabled, try with the other key supplied (brown). If the engine cannot be started, contact an **Authorised Piaggio Service Centre**, which is provided with the electronic equipment required to detect and repair the system.

When supplementary keys are required, remember that the programming (up to a maximum of three keys) must be performed on all the keys whether they are new or already in your possession.

Take the key with the brown grip and all the black keys supplied to an **Authorised Piaggio Service Centre**.

The codes of keys not submitted for the new storage procedure are deleted from the memory. Any lost keys will therefore not be enabled to start the engine.

#### **WARNING**



**EACH KEY HAS ITS OWN AND UNIQUE CODE, WHICH MUST BE STORED BY THE SYSTEM CONTROL UNIT.**

**VIOLENT SHOCKS MAY AFFECT THE ELECTRONIC COMPONENTS OF THE KEY.**

**SHOULD THE VEHICLE CHANGE OWNERS, IT IS ABSOLUTELY NECESSARY THAT THE NEW OWNER GET POSSESSION OF THE KEY WITH THE BROWN GRIP (AS WELL AS ALL OTHER KEYS) AND THE «CODE CARD»**

### **Programming the immobilizer system**

Below is described the procedure to follow for programming the **PIAGGIO IMMOBILIZER** system and/or for storing other key codes.

#### **Procedure start - brown key**

Insert the brown key into the key switch (in the «**OFF**» position), turning it to the «**ON**» position. After 1 - 3 seconds, turn the key to "**OFF**" again and pull it out.

#### **Intermediate step - black key**

After extracting the brown key, insert the black key within 10 seconds and promptly turn it to «**ON**». After 1-3 seconds, turn the key to "**OFF**" again and pull it out.

In this way, a maximum of 3 black keys can be programmed by repeating the above procedure keeping the indicated times.

### Final step - brown key

After extracting the last black key, insert the brown key again and turn it to «**ON**» (carry out this operation within 10 seconds after extracting the previous key). Leave it in this position for 1 to 3 seconds and return it to the «**OFF**» position.

### Proper programming check

Insert the brown key disabling the transponder (i.e., by tilting the key hood by 90°), and turn the key to «**ON**». Perform the engine start-up operation. Ensure that the engine does not start. Insert the black key and repeat the start-up operation. Check that the engine does start.

#### **N.B.**

**IF THE ENGINE STARTS WITH THE BROWN KEY (AND WITH A DISABLED TRANSPONDER) OR IF DURING THE PROGRAMMING A WRONG STEP HAS BEEN CARRIED OUT, IT IS NECESSARY TO REPEAT THE PROCESS FROM THE BEGINNING.**



01\_13

### The saddle

Saddles fitted to this scooter are upholstered in Authentic Leather, and are a stylish accessory to emphasise an already exclusive product such as your Vespa. As leather is a natural and vivid material, it tends to get "very opaque" aspect as time goes by, an aspect typical of Authentic Leather. This product may also show characteristic undertones and strains.

To care and maintain the features of the saddle through time, follow these tips: Do not expose it to weather changes, when the scooter is parked protect it with the waterproof cover supplied and stored under the saddle.

Periodically, especially during rainy seasons, apply commercially available waterproofing products (footwear spray). Do not apply shoe polish or wax on the saddle so as not to stain your clothes.



In case of forced and prolonged exposure to water, dry the saddle far from any heat source, do not to use alcohol, solvent-based products and pay special care when refuelling.

If the saddle gets stained, wipe the area and if necessary wash it with lukewarm water and neutral soap.

To prevent the waterproof cover from being taken away when the scooter is left unattended, fasten it with hook next to the saddle hinge.

### Opening the saddle (01\_13)

Insert the key into the saddle lock «A», turn it anticlockwise and tip the saddle forward.

### Identification (01\_14, 01\_15)

The identification numbers consist of a prefix stamped on the chassis and on the engine, followed by a number. They should always be given when requesting spare parts. We recommend that you check that the prefix and chassis number stamped on the vehicle correspond with those in the vehicle documents.

#### CAUTION



**BE REMINDED THAT ALTERING IDENTIFICATION REGISTRATION NUMBERS CAN LEAD TO SERIOUS PENAL SANCTIONS (IMPOUNDING OF THE VEHICLE, ETC.).**



01\_14



01\_15



### Rear top box opening (01\_16)

Turn the key to the position «**OFF**». Then press it. With the key is in «**LOCK**» the glove-box is locked.

# Vespa LXV 125

**Vespa®**



**Chap. 02  
Use**

## Checks

Before using the vehicle, check:

1. that the fuel tank is full.
2. The oil level in the rear hub.
3. engine oil level (see section «Engine oil level»).
4. That tyres are properly inflated.
5. correct functioning of headlights, rear taillight and turn indicators.
6. The correct functioning of the front and rear brakes.

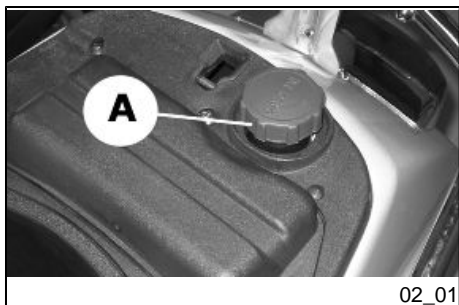

02\_01

## Refuelling (02\_01)

Fill fuel tank«A» with unleaded petrol (minimum octane rating = 95).

When the fuel reaches the reserve level, the warning light fitted on the instrument panel lights up.

### CAUTION



**SHUT OFF THE ENGINE BEFORE REFUELLING WITH PETROL. PETROL IS HIGHLY FLAMMABLE. DO NOT LET PETROL SPILL FROM THE TANK OR WHILE REFUELLING**

### CAUTION



**DO NOT BRING NAKED FLAMES OR CIGARETTES NEAR THE MOUTH OF THE FUEL TANK: FIRE HAZARD. ALSO AVOID INHALING HARMFUL VAPOURS.**

**CAUTION**

**USING OILS OTHER THAN THOSE RECOMMENDED CAN SHORTEN THE LIFE OF THE ENGINE.**

**Characteristic****Fuel tank capacity**

~ 8.5 l (2 l of which is reserve)

**Tyre pressure****CAUTION**

**TYRE PRESSURE SHOULD BE CHECKED WHEN TYRES ARE COLD. INCORRECT TYRE PRESSURE CAUSES ABNORMAL TYRE WEAR AND MAKES RIDING DANGEROUS.**

**TYRES MUST BE REPLACED WHEN THE TREAD REACHES THE WEAR LIMITS SET FORTH BY LAW.**

**Characteristic****Front tyre pressure**

1.6 bar

**Rear tyre pressure**

2 bar

**Rear wheel pressure (rider and passenger):**

2.3 bar

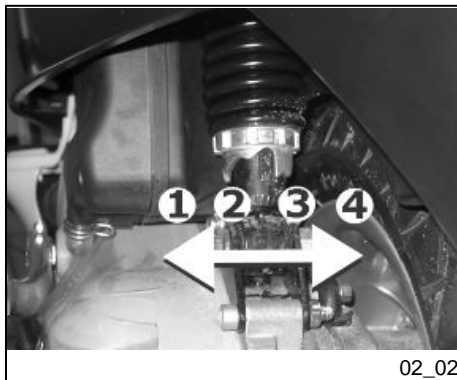

02\_02

## Shock absorbers adjustment (02\_02)

The preloading of the springs can be adjusted to 4 positions using the ring nut located in the lower part of the shock absorbers and the specific spanner supplied.

**Position 1:** minimum preload: driver only

**Position 2:** medium preloading: driver only

**Position 3:** medium preloading: rider and passenger

**Position 4:** maximum preloading: driver, passenger, and luggage.

In order to carry out this operation you will need to use the specific spanner in the kit.

### CAUTION



**RIDING THE VEHICLE WITH THE SPRING PRELOADING NOT CORRECTLY SET FOR THE RIDER AND POSSIBLE PASSENGER, COULD REDUCE THE COMFORT OF THE RIDE AND THE PRECISION OF THE STEERING.**

### WARNING



**WE RECOMMEND WEARING GLOVES WHILE CARRYING OUT THIS OPERATION IN ORDER TO AVOID INJURIES.**

## Running in

### WARNING



**DURING THE FIRST 1000 KM DO NOT RIDE THE VEHICLE OVER 80% OF ITS MAXIMUM SPEED. AVOID TWISTING THE THROTTLE GRIP FULLY OR KEEPING A CONSTANT SPEED ALONG LONG SECTIONS OF ROAD. AFTER THE**

**FIRST 1000 KM, GRADUALLY INCREASE SPEED UNTIL REACHING THE MAXIMUM PERFORMANCE.**

### Starting up the engine (02\_03)

The scooter is fitted with automatic transmission with a regulator and centrifugal clutch. Therefore always start the engine with the throttle at a minimum; to start-off from still, progressively twist the throttle grip.

The vehicle is equipped with an electric fuel pump and a starter that switch on automatically as soon as the engine is started.

In order to start the engine, it is necessary to pull either the rear brake lever "B" or the front brake lever "C", before pressing the starting button, "A", so as to disengage the safety switches.

**1:** Put the scooter on its stand "E"; check that the rear tire is off the ground.

**2:** Insert the key into the ignition switch, "D", and turn to the **ON** position.

**3:** Under any ambient temperature it is necessary to twist the throttle grip slightly to facilitate the first start-up every morning or after average or long halts; keep the throttle at idle once the engine is warm.

**4:** Push the starter button «A» after pulling the rear brake lever «B» or the front brake lever «C».

#### CAUTION



**DO NOT CARRY OUT THESE OPERATIONS IN CLOSED AREAS SINCE EXHAUST GASES ARE TOXIC.**

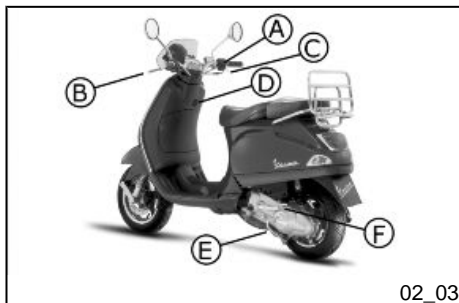

02\_03

**CAUTION**

**DUE TO THE HIGH TEMPERATURES THE CATALYTIC CONVERTER CAN REACH, ALWAYS TAKE CARE, WHEN PARKING THE SCOOTER, THAT THE EXHAUST DOES NOT COME INTO CONTACT WITH FLAMMABLE MATERIALS, TO AVOID SERIOUS BURNS.**

**Precautions****CAUTION**

**NEVER STRESS THE ENGINE AT LOW TEMPERATURES IN ORDER TO AVOID POSSIBLE DAMAGE. BE CAREFUL NEVER TO EXCEED THE MAXIMUM SPEED WHILE RUNNING DOWNHILL, IN ORDER TO AVOID DAMAGING THE ENGINE. IN ANY CASE, IN ORDER TO PRESERVE THE ENGINE FROM PROLONGED EXCESSIVE REVOLUTIONS, THE REVOLUTION LIMITER WILL BE ACTIVATED IF THE ENGINE SPEED EXCEEDS THE ESTABLISHED THRESHOLD.**

**WARNING**

**AFTER A LONG DISTANCE COVERED AT THE MAXIMUM SPEED, DO NOT STOP THE ENGINE IMMEDIATELY, BUT LET IT RUN AT IDLE FOR A FEW SECONDS.**

**WARNING**

**DO NOT RIDE THE SCOOTER AT MAXIMUM REVS FOR A LONG TIME; EVEN THOUGH THE ENGINE IS PROVIDED WITH AN ELECTRONIC REVOLUTION LIMITER, DO NOT DO ACCELERATE AT MAX REVS FOR A LONG TIME AS THIS**



**COULD CAUSE OVERHEATING AND THE CATALYTIC CONVERTER CAN BE DAMAGED.**

### Difficult start up (02\_04)

If there is a problem you can follow the instructions below:

**1. Carburettor flooded.** Place the vehicle on the centre stand and check that the rear tyre is off the ground. Open the throttle fully and press the starter button for five seconds and then stop for five seconds. If the engine does not start after a few attempts, let the engine sit for a few minutes and then repeat the above operations. In any case do not operate the starter longer than 20" in the attempt to start the engine.

**2. Battery or starter motor inefficiency.** Put the scooter on its stand "E"; make sure that the rear wheel is off the ground, turn the key switch «D» to «ON» and use the kick-starter «F».

#### CAUTION



**ALWAYS PLACE THE VEHICLE ON ITS STAND BEFORE KICK STARTING.**

#### WARNING



**TAMPERING MAY CAUSE SERIOUS ENGINE MALFUNCTION.**

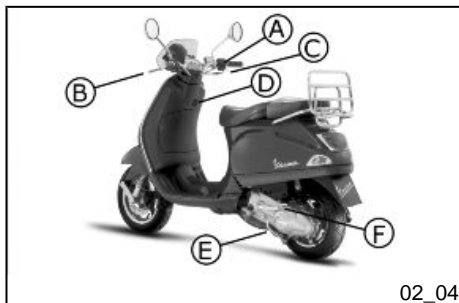

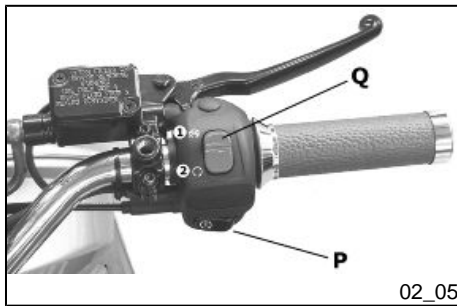

## Stopping the engine (02\_05)

After stopping the engine, set the engine stop switch «Q» to «OFF».

## Automatic transmission

To ensure simple, pleasurable riding, the vehicle is equipped with automatic transmission with regulator and centrifugal clutch. The system is designed to give the best possible performance in terms of both acceleration and consumption, on level ground and uphill, thanks to the adjustments made to engine speed and transmitted torque. If you have to stop on an uphill slope (traffic lights, traffic jam, etc.) only use the brake to keep the vehicle still, leaving the motor running at idling speed. Using the motor to keep the vehicle still can cause the clutch to overheat. This problem is due to the friction of the clutch parts on the clutch bell. It is therefore recommended to avoid conditions of prolonged clutch slippage leading to clutch overheating (for example, as well as the situation described above, riding uphill fully laden on steep slopes or starting off on slopes greater than 25%, etc.):

1. Do not continue riding in such conditions.
2. Let the clutch cool down with the motor at idling speed for a few minutes.

## Safe driving

### WARNING



**SOME SIMPLE TIPS ARE PROVIDED BELOW THAT WILL ENABLE YOU TO USE YOUR SCOOTER ON A DAILY BASIS IN GREATER SAFETY AND WITH MORE PEACE OF MIND.**

<

Your ability and your knowledge of the vehicle form the basis of safe riding. We recommend trying out the vehicle in traffic-free zones to get to know your vehicle completely.

#### **ALWAYS DRIVE WITHIN YOUR LIMITS**

1. Before riding off, remember to put on your helmet and fasten it correctly.
2. Reduce speed and ride cautiously on uneven roads.
3. Remember that after riding on a long stretch of wet road without using the brakes, the braking effect is initially lower. Given these conditions, it is a good idea to operate the brakes from time to time.
4. Do not brake hard on a wet surface, on dirt tracks or on any slippery road surface.
5. If you have to brake, use both brakes in order to divide the braking action between both wheels.
6. Avoid starting off by mounting the scooter while it is still resting on its stand. In any case, the rear wheel should not be turning when it comes into contact with the ground, in order to avoid abrupt departures.
7. If the vehicle is used on roads covered with sand, mud, snow mixed with salt, etc., clean the brake disc frequently with mild detergent in order to prevent abrasive substances from building up within the holes, which can result in early wear of the brake pads.

8. Any elaboration that modifies the vehicle's performances, such as tampering with original structural parts is strictly forbidden by law, and renders the vehicle not conforming to the approved type and therefor dangerous to ride.

**CAUTION**

**DO NOT FORGET THAT DRIVING IN A STATE OF DRUNKENNESS, OR WHEN UNDER THE EFFECT OF DRUGS OR CERTAIN MEDICINES, CAN BE EXTREMELY DANGEROUS FOR ONESELF AND FOR OTHERS.**

**CAUTION**

**ANY CHANGES TO THE VEHICLE PERFORMANCE AS WELL AS ALTERATIONS TO ORIGINAL STRUCTURAL PARTS IS STRICTLY FORBIDDEN BY LAW, AND RENDERS THE VEHICLE NO LONGER CONFORMING TO THE APPROVED TYPE AND DANGEROUS FOR RIDING.**

# Vespa LXV 125

**Vespa®**



**Chap. 03  
Maintenance**



03\_01

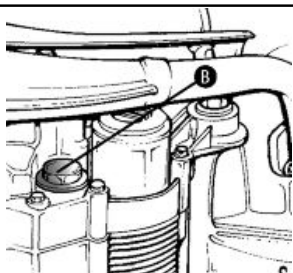

03\_02



03\_03

## Engine oil level (03\_01)

In 4T engines, engine oil is used to lubricate the distribution elements, main bearings and thermal group. **An insufficient quantity of oil can cause serious damage to the engine itself.** In all four-stroke engines, a loss of efficiency in oil performance and consumption should be considered normal. Consumption can particularly reflect the conditions of use (i.e. when driving at "full acceleration" all the time, oil consumption increases). The replacement frequencies provided for by the maintenance programme are defined, depending on the total contents of oil in the engine and average consumption measured following standardised methods. **In order to prevent any problems, we recommend checking oil level more frequently than indicated in the Scheduled Maintenance table or before setting off on long journeys. The vehicle is, however, equipped with an oil pressure warning light on the instrument panel.**

## Engine oil level check

Every time the scooter is used, a visual check should be made on the level of the engine oil when the engine is cold. The oil level should be somewhere between the **MAX** and **MIN** index marks on the level bar; the check **MUST** be made with the scooter upright, resting on the centre stand.

If the check is carried out after the vehicle has been used, and therefore with a hot engine, the level line will be lower; in order to carry out a correct check, wait at least 10 minutes after the engine has been stopped so as to get the correct level.

### CAUTION



**USING THE ENGINE WITH INSUFFICIENT LUBRICATION OR WITH THE WRONG LUBRICANTS MAY INCREASE WEAR AND TEAR ON THE MOVING PARTS AND MAY CAUSE SERIOUS DAMAGE.**

## Characteristic

Engine oil

1100 cm<sup>3</sup>

## Engine oil top-up

Always check oil level before carrying out top-ups and add oil **without exceeding the MAX level**. An engine oil check-up and top-up should be carried out every 3,000 km at an **Authorised Piaggio Service Centre**.

## Warning light (insufficient oil pressure)

The vehicle is equipped with a warning light that lights up when the key is turned to the «ON». However, this light should switch off once the engine has been started. **If the light comes on while braking, at idle speed or while turning a corner, it is necessary to check the oil level and top it up if required. If after having topped-up the oil, the warning light still comes on while braking, at idle speed or while turning a corner, it will be necessary to take your vehicle to an Authorised Service Centre.**

## Engine oil change (03\_02, 03\_03)

Oil must be changed and filter replaced at an **Authorised Service Centre** (as indicated in the Scheduled Maintenance Table). The engine should be emptied by draining the oil from the drainage plug «B » of the gauze filter on the flywheel side. In order to facilitate oil drainage, loosen the cap/dipstick «A». Since a certain quantity of oil remains in the circuit still, the top-up should be carried out from the cap «A».

Then start up the scooter, leave it running for a few minutes and switch it off: after about five minutes check the level and if necessary top up **without exceeding the MAX level**.

The cartridge filter must be replaced every time the oil is changed. For top-ups and changes use new oil of the recommended type.

### WARNING



**RUNNING THE ENGINE WITH INSUFFICIENT LUBRICATION OR WITH INADEQUATE LUBRICANTS ACCELERATES THE WEAR AND TEAR OF THE MOVING PARTS AND CAN CAUSE IRRETRIEVABLE DAMAGE.**

**CAUTION**

**USED OILS CONTAIN SUBSTANCES HARMFUL TO THE ENVIRONMENT. FOR OIL REPLACEMENT, CONTACT AN AUTHORISED SERVICE CENTRE, WHICH IS EQUIPPED TO DISPOSE OF USED OILS IN AN ENVIRONMENTALLY FRIENDLY AND LEGAL WAY.**

**Recommended products****AGIP CITY HI TEC 4T**

*Engine oil*

SAE 5W-40, API SL, ACEA A3, JASO MA Synthetic oil

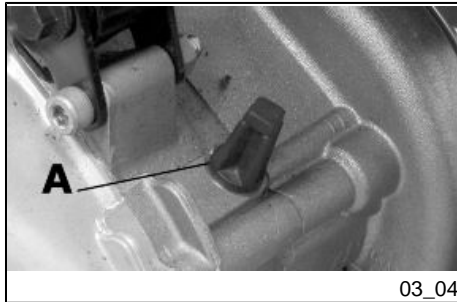
**Hub oil level (03\_04, 03\_05, 03\_06)**

Check the oil in the rear hub.

To check the rear hub oil level, proceed as follows:

- 1) Park the scooter on level ground and place it on the centre stand.
- 2) Unscrew the dipstick "A", dry it with a clean rag and then reinsert it, **screwing it tightly into place**;
- 3) Pull out the dipstick and check that the oil level is between the MIN and MAX notches. If the oil level is below the MIN notch, top up with the required amount of hub oil.
- 4) Screw the dipstick back in, checking that it is locked in place.

**N.B.**

**THE REFERENCE MARKS ON THE HUB OIL LEVEL DIPSTICK, EXCEPT FOR THE ONE INDICATING THE "MAX" LEVEL, REFER TO OTHER MODELS BY THE MANUFACTURER AND HAVE NO SPECIFIC FUNCTION FOR THIS MODEL.**



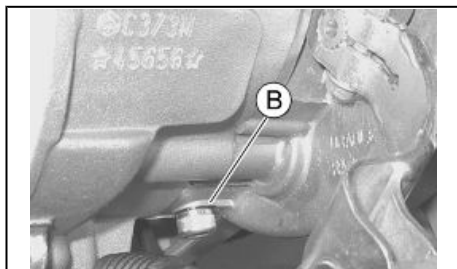

03\_05

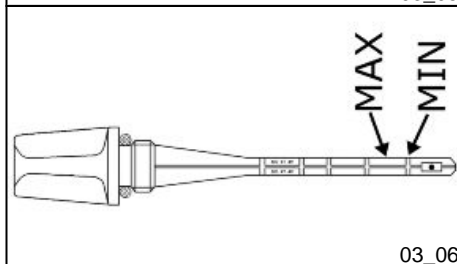

03\_06

**CAUTION**

**RIDING THE VEHICLE WITH INSUFFICIENT HUB LUBRICATION OR WITH CONTAMINATED OR IMPROPER LUBRICANTS ACCELERATES THE WEAR AND TEAR OF THE MOVING PARTS AND CAN CAUSE SERIOUS DAMAGE.**

**CAUTION**

**USED OILS CONTAIN SUBSTANCES HARMFUL TO THE ENVIRONMENT. FOR OIL REPLACEMENT, CONTACT AN AUTHORISED SERVICE CENTRE, WHICH IS EQUIPPED TO DISPOSE OF USED OILS IN AN ENVIRONMENTALLY FRIENDLY AND LEGAL WAY.**

**Recommended products****AGIP ROTRA 80W-90**

*Rear hub oil*

SAE 80W/90 Oil that exceeds the requirements of API GL3 specifications

**Characteristic****Hub oil**

Capacity ~ 100 cc

**REPLACEMENT**

- 1) Remove the dipstick.
- 2) Unscrew the oil drainage screw «B» and drain out all the oil.
- 3) Screw back the drainage screw and refill the hub using the recommended oil quantity and type.

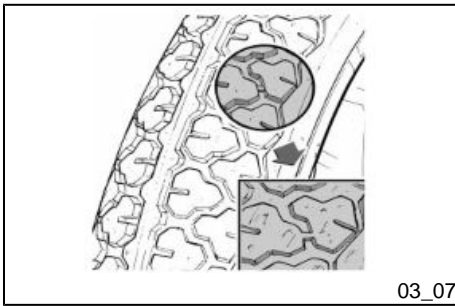

## Tyres (03\_07)

Periodically check the inflation pressure of each tyre (when cold).

Tyres are fitted with wear indicators; tyres should be replaced as soon as these indicators become visible on the tyre tread. Also check that the tyres do not show signs of splitting at the side or irregular tread wear; If this occurs, go to an authorised workshop or at least a workshop equipped to perform the removal and the refitting.

### CAUTION



**TYRE PRESSURE SHOULD BE CHECKED WHEN TYRES ARE COLD. INCORRECT TYRE PRESSURE CAUSES ABNORMAL TYRE WEAR AND MAKES RIDING DANGEROUS.**

**TYRES MUST BE REPLACED WHEN THE TREAD REACHES THE WEAR LIMITS SET FORTH BY LAW.**

### Characteristic

#### Front tyre pressure

1.6 bar

#### Rear tyre pressure

2 bar

#### Rear wheel pressure (rider and passenger):

2.3 bar

## Spark plug dismantlement (03\_08, 03\_09, 03\_10, 03\_11)

In order to inspect the spark plug, follow the operation described when the engine is cold:

1. Lift the saddle and remove the helmet compartment "A";
2. Remove the spark plug inspection door "B";
3. Detach the spark plug cap;
4. slide the door «C» on the engine cover upwards;
5. Remove the spark plug with the supplied spanner "D" (with retaining rubber).

To refit, repeat the procedure in reverse order using the spanner to insert the spark plug or to tighten it in its seat. Care should be taken to installing and fixing it with correct inclination

Be extremely careful when carrying out the operations described above, insert your left hand on the spark plug inspection door side and your right hand from the helmet compartment side.

To refit the door follow the steps in reverse order, making sure to insert the pin in the central cover.

### WARNING



**THE SPARK PLUG MUST BE REMOVED WHEN THE ENGINE IS COLD. THE USE OF A SPARK PLUG WITH THERMAL GRADE OR THREAD OTHER THAN THE INDICATED TYPE (SEE «DATA» SECTION) CAN SERIOUSLY DAMAGE THE ENGINE. REPLACE SPARK PLUGS AT THE INTERVALS INDICATED IN THE SCHEDULED MAINTENANCE TABLE.**

### N.B.

**THE USE OF SPARK PLUGS OTHER THAN THE INDICATED TYPE OR OF SHIELDLESS SPARK PLUG CAPS CAN CAUSE ELECTRICAL SYSTEM FAILURES.**



03\_08



03\_09



03\_10



03\_11

## Characteristic

### Spark plug

CHAMPION RG6YC - NGK CR7EB

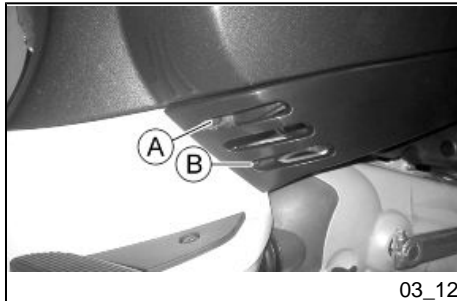

03\_12

## Removing the air filter (03\_12, 03\_13)

Remove the side fairing unscrewing the 2 screws marked **A**. Remove the air cleaner cap «**D**» after unscrewing the 6 fixing screws «**C**», then remove the filtering element. Clean with water and shampoo, afterwards dry with compressed air and submerge in a recommended oil and petrol mixture in ratio of 50%. Afterwards squeeze it, leave it to dry and mount it again.

### CAUTION



**IN CASE OF RIDING ON DUSTY ROADS IT IS ADVISABLE TO CLEAN THE AIR FILTER MORE FREQUENTLY THAN INDICATED IN THE RELEVANT CHAPTER ON SCHEDULED MAINTENANCE.**

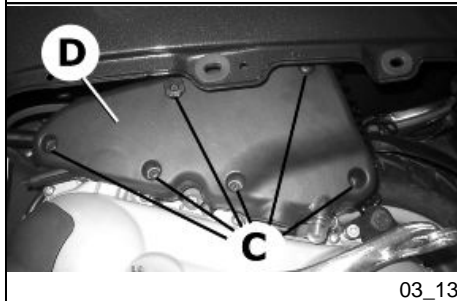

03\_13

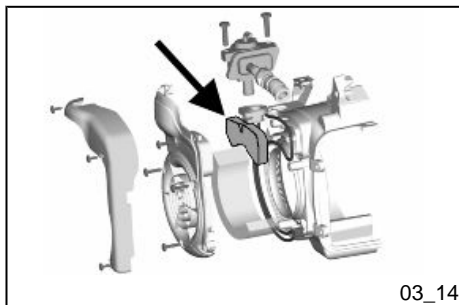

### Secondary air system (03\_14)

In order to reduce polluting emissions, the vehicle is furnished with a catalytic converter in the muffler.

To favour the catalytic process, an extra amount of oxygen is added via a secondary air system (SAS).

This system allows more oxygen to be added to the unburned gases before they reach the converter, thus improving the action of the catalytic converter.

The air enters the exhaust duct from the head, and is purified by a black filter.

The system is fitted with a control valve that disables operation while decelerating to avoid unwanted noise.

To ensure the best functioning of the SAS system, every 12,000 km the scooter should be taken to an **Authorised Piaggio Service Centre** to have the filter cleaned (Scheduled maintenance operations section).

The filter sponge should be cleaned with water and mild soap, then it should be dried with a cloth and slight blows of compressed air.

#### CAUTION



**CONTACT AN AUTHORISED PIAGGIO SERVICE CENTRE TO CARRY OUT THESE OPERATIONS.**

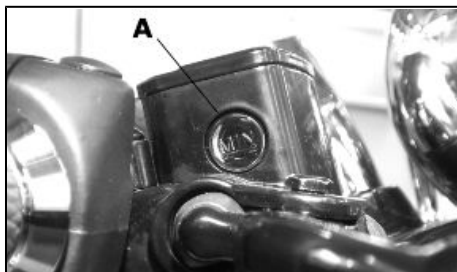

03\_15



03\_16

## Checking the brake oil level (03\_15, 03\_16)

The brake fluid reservoir is equipped with a sight glass «A» made of transparent material; the quantity of liquid contained in the sight glass indicates the level of liquid in the reservoir.

When the sight glass «A» is full, the level inside the reservoir exceeds the MIN level; when it is partially full, the level drops to the MIN level; when it is fully empty, the level of fluid in the reservoir is below the MIN level.

The brake fluid level may fall due to wear on the brake pads. In case the pad wear is below the minimum mark, contact an **Authorised Service Centre** to have the braking system thoroughly checked. If you need to top up the level, follow the steps listed below. Unscrew the 2 screws "B", remove the tank cap "C" and pour in the required quantity of fluid (the brake fluid level must be above minimum). Place the handlebar in the riding position and pay attention not to tilt the vehicle in order to keep the brake fluid reservoir in horizontal position when checking the fluid level.

### CAUTION



**TOP UPS SHOULD ONLY BE CARRIED OUT WITH DOT 4 CLASSIFIED BRAKE FLUID.**

### WARNING



**IN NORMAL CLIMATIC CONDITIONS IT IS ADVISABLE TO REPLACE THE ABOVE-MENTIONED FLUID EVERY 2 YEAR. NEVER USE BRAKE FLUID CONTAINED IN CONTAINERS WHICH ARE ALREADY OPEN OR PARTIALLY USED.**

### CAUTION



**THE BRAKING CIRCUIT FLUID IS HIGHLY CORROSIVE. THEREFORE, WHEN TOPPING IT UP, AVOID LETTING IT COME INTO CONTACT WITH THE PAINTED**

PARTS OF THE VEHICLE. THE BRAKING CIRCUIT FLUID IS HYGROSCOPIC, WHICH MEANS THAT IT ABSORBS MOISTURE FROM THE SURROUNDING AIR. IF MOISTURE CONTAINED IN THE BRAKE FLUID EXCEEDS A CERTAIN VALUE, THIS WILL RESULT IN INEFFICIENT BRAKING.

### Battery (03\_17)

To access the battery, tilt the saddle forwards, then remove the battery compartment access door by unscrewing the star-shaped screw "A" shown in the figure.

The battery is the electrical device that requires the most frequent attention and the most thorough maintenance.

#### WARNING



SPENT BATTERIES ARE HARMFUL FOR THE ENVIRONMENT. COLLECTION AND DISPOSAL SHOULD BE CARRIED OUT IN COMPLIANCE WITH CURRENT REGULATIONS.

#### CAUTION



ELECTROLYTE CONTAINS SULPHURIC ACID: AVOID CONTACT WITH EYES, SKIN AND CLOTHES. IN THE CASE OF ACCIDENTAL CONTACT, RINSE WITH ABUNDANT OF WATER AND CONSULT A DOCTOR.

#### CAUTION



IN ORDER TO AVOID DAMAGING THE ELECTRICAL SYSTEM, NEVER DISCONNECT THE WIRING WHILE THE ENGINE IS RUNNING. DO NOT TIP THE SCOOT-

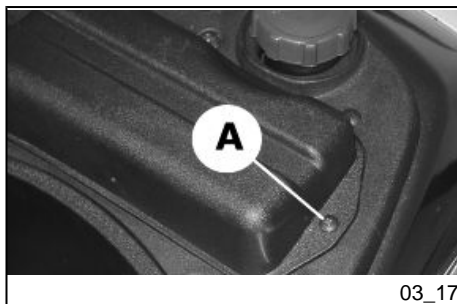

## ER TOO MUCH IN ORDER TO AVOID DANGEROUS LEAKAGE OF BATTERY ELECTROLYTE

### Checking the electrolyte level

The electrolyte level, which should be checked regularly, must always be at the maximum level. To reach this level, use only distilled water. Should it become necessary to top up the battery with water too frequently, check the scooter's electrical system because the battery is being overloaded, causing it to lose power quickly.

#### CAUTION



**ELECTROLYTE CONTAINS SULPHURIC ACID: AVOID CONTACT WITH EYES, SKIN AND CLOTHES. IN THE CASE OF ACCIDENTAL CONTACT, RINSE WITH ABUNDANT OF WATER AND CONSULT A DOCTOR.**

### Long periods of inactivity

Battery performance will decrease if the vehicle is not used for a long time. This is the result of the natural phenomenon of battery discharging plus residual absorption by vehicle components with constant power consumption. Poor battery performance may also be due to environmental conditions and the cleanness of the poles. In order to avoid difficult starts and/or irreversible damage to the battery, follow any of these steps:

- **At least once a month** start the engine and run it slightly above idle speed for 10-15 minutes. This keeps all the engine components, as well as the battery, in good working order.
- Take your vehicle to a garage (as indicated in the "Vehicle not used for extended periods" section) to have the battery removed. Have the battery cleaned, charged fully and stored in a dry, ventilated place. Recharge **at least once every two months**.



**N.B.**

**THE BATTERY MUST BE CHARGED WITH A CURRENT EQUAL TO 1/10 OF THE RATED CAPACITY OF THE BATTERY AND FOR NOT LONGER THAN 10 HOURS. CONTACT AN AUTHORISED SERVICE CENTRE TO CARRY OUT THIS OPERATION SAFELY. WHEN REFITTING THE BATTERY MAKE SURE THE LEADS ARE CORRECTLY CONNECTED TO THE TERMINALS.**

**WARNING**



**DO NOT DISCONNECT THE BATTERY CABLES WITH THE ENGINE RUNNING, THIS CAN CAUSE PERMANENT DAMAGE TO THE VEHICLE ELECTRONIC CONTROL UNIT.**

**WARNING**



**SPENT BATTERIES ARE HARMFUL FOR THE ENVIRONMENT. COLLECTION AND DISPOSAL SHOULD BE CARRIED OUT IN COMPLIANCE WITH CURRENT REGULATIONS.**

### **Fuses (03\_18, 03\_19, 03\_20)**

The electrical system is protected by two 15A fuses «B» located next to the battery and by two 7.5A fuses located under the front grille. To remove the front grille, remove the plate with the Piaggio logo on the front shield using a screwdriver; then, remove the screw underneath

**CAUTION**



**IN ORDER TO AVOID DAMAGING THE ELECTRICAL SYSTEM, NEVER DISCONNECT THE WIRING WHILE THE ENGINE IS RUNNING. DO NOT TIP THE SCOOT-**

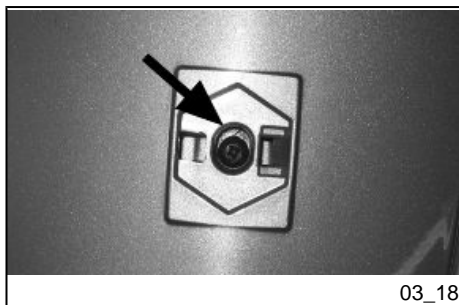

03\_18



03\_19

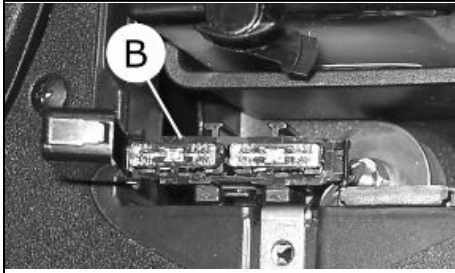

03\_20

ER TOO MUCH IN ORDER TO AVOID DANGEROUS LEAKAGE OF BATTERY ELECTROLYTE

**CAUTION**



MODIFICATIONS OR REPAIRS TO THE ELECTRICAL SYSTEM, PERFORMED INCORRECTLY OR WITHOUT STRICT ATTENTION TO THE TECHNICAL SPECIFICATIONS OF THE SYSTEM, CAN CAUSE ERRORS IN FUNCTIONING AND RISK OF FIRE.

**CAUTION**



BEFORE REPLACING THE BLOWN FUSE, FIND AND SOLVE THE FAILURE THAT CAUSED IT TO BLOW. NEVER TRY TO REPLACE THE FUSE WITH ANY OTHER MATERIAL (E.G., A PIECE OF ELECTRIC WIRE).

**BULBS**

High/low beam light bulb

**Type:** Halogen (H4)

**Power:** 12V - 55/60W

**Quantity:** 1

Front tail light bulb

**Type:** All glass

**Power:** 12V 5W

**Quantity: 1**

Front turn indicator bulb

**Type:** Spherical**Power:** 12V - 10W**Quantity:** 1 RHS + 1 LHS

Rear turn indicator light bulb

**Type:** Spherical**Power:** 12V - 10W**Quantity:** 1 RHS + 1 LHS

Stop and tail light bulb

**Type:** Spherical**Power:** 12V 21/5W**Quantity:** 1

12V - 2W warning light bulbs

**Type:** All glass**Function:** Turn indicators, engine oil, fuel reserve, high-beam light**Quantity:**4

Instrument panel light bulbs

**Type:** All glass**Power:** 12V 1.2W**Quantity:** 4

License plate light bulb

**Type:** ALL GLASS**Power:** 12V - 5W**Quantity:** 1

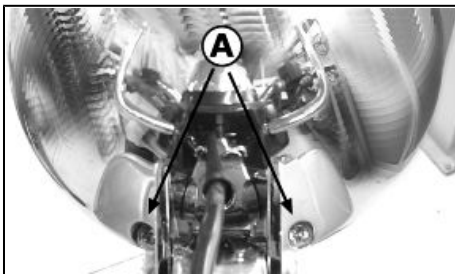

03\_21



03\_22



03\_23

## Front light group (03\_21, 03\_22, 03\_23)

To access the headlight bulbs it is necessary to:

- 1) Remove the two screws «A» on the headlamp attachments to the support.
- 2) With the aid of a screwdriver gently lever up the lower part of the parabole in order to release it.
- 3) To access the low-/high-beam headlight bulb turn the bulb holder anticlockwise and remove it. To reach the turn indicator bulb, gently pull the lamp holder.

### **N.B.**

**IF MISTING IS NOTICED ON THE INSIDE OF THE HEADLAMP GLASS, THIS DOES NOT INDICATE A FAULT AND IS RELATED TO THE HUMIDITY AND/OR TO LOW TEMPERATURES.**

**THE PHENOMENON SHOULD QUICKLY DISAPPEAR WHEN THE LIGHT IS SWITCHED ON.**

**THE PRESENCE OF DROPS OF WATER, ON THE OTHER HAND, COULD INDICATE THAT WATER IS INFILTRATING. CONTACT THE PIAGGIO AFTER-SALES SERVICE NETWORK.**

## Electric characteristic

### **Bulbs**

- 1 piece 12V/55-60W bulb for high- and low-beam light
- 1 piece 12V/5W bulb for taillights

## **Headlight adjustment (03\_24, 03\_25)**

Proceed as follows:

1. Place the vehicle in running order and with the tyres inflated to the prescribed pressure, on a flat surface 10 m away from a white screen situated in a shaded area, making sure that the longitudinal axis of the scooter is perpendicular to the screen;



03\_24

2. Turn on the headlight and check that the borderline of the projected light beam on the screen is not lower than 9/10 of the distance from the ground to the centre of vehicle headlamp and higher than 7/10;

3. If it is, loosen the headlight support fixing screws and adjust the headlight direction.

#### N.B.

**THE ABOVE PROCEDURE COMPLIES WITH THE EUROPEAN STANDARDS REGARDING MAXIMUM AND MINIMUM HEIGHT OF LIGHT BEAMS. REFER TO THE STATUTORY REGULATIONS IN FORCE IN EVERY COUNTRY WHERE THE vehicle IS USED.**

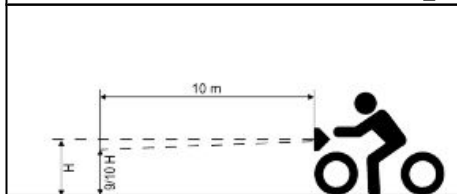

03\_25

### Front direction indicators (03\_26)

To replace the front turn indicator bulbs, remove the tail light taking out the retaining screw "A", remove the bulb holder from its fitting; gently turn the bulb around 30° and remove it. Follow the process in reverse order to refit.

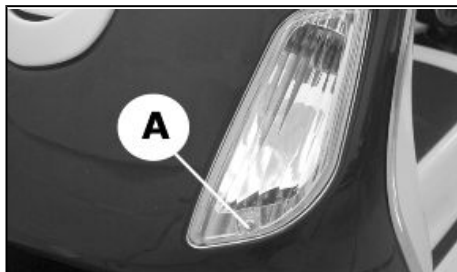

03\_26

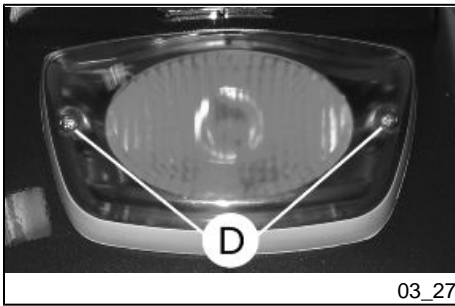

03\_27

### Rear optical unit (03\_27)

To access the rear taillight bulb it is necessary to remove the 2 fixing screws «D». Gently push and turn the bulb about 30° and then remove it. To refit follow the same steps but in reverse order.

#### N.B.

**IF MISTING IS NOTICED ON THE INSIDE OF THE HEADLAMP GLASS, THIS DOES NOT INDICATE A FAULT AND IS RELATED TO THE HUMIDITY AND/OR TO LOW TEMPERATURES.**

**THE PHENOMENON SHOULD QUICKLY DISAPPEAR WHEN THE LIGHT IS SWITCHED ON.**

**THE PRESENCE OF DROPS OF WATER, ON THE OTHER HAND, COULD INDICATE THAT WATER IS INFILTRATING. CONTACT THE PIAGGIO AFTER-SALES SERVICE NETWORK.**



03\_28

### Rear turn indicators (03\_28)

To gain access to the turn indicator bulbs, remove the fastening screws «E».

The bulbs have a bayonet coupling, to remove them press gently and twist anticlockwise about 30°. To refit follow the same steps but in reverse order.

**Number plate light (03\_29, 03\_30)**

Reach the back of the license plate support.

Use a screwdriver to remove the 2 screws "A" and detach the license plate lamp cover.

Then remove the bulb "B"

**Electric characteristic****License plate light bulb**

12V - 5W

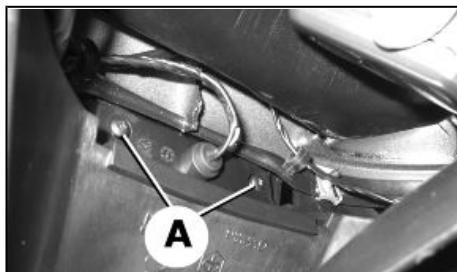

03\_29

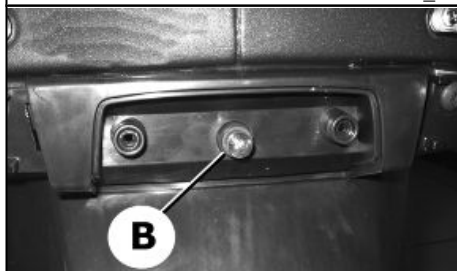

03\_30

**Rear-view mirrors (03\_31)**

The mirrors can be set to the desired position by adjusting the mirror frame.

To remove the rear-view mirror loosen the lock nut indicated in the figure and turn the supporting stem anticlockwise.



03\_31

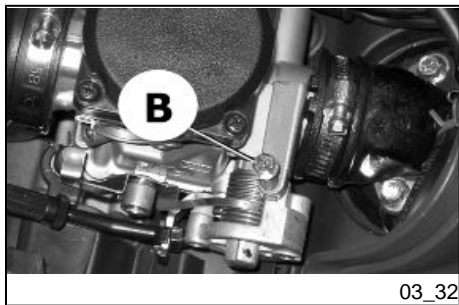

03\_32

## Idle adjustment (03\_32)

Proceed as follows:

1. Rest the scooter on its centre stand and lift the saddle (as described in the «Saddle opening to reach helmet compartment» section).
2. Remove the helmet compartment.
3. To adjust the idle speed, start the engine, then loose or tighten the screw «B» until you reach the recommended idle speed taking care the engine does not make the rear wheel move.

If adjustment is difficult, take your vehicle to a **Dealer or an Authorised PIAGGIO Service Centre** to adjust **CO** to idle speed.

### WARNING



**IDLE SPEED MUST BE ADJUSTED WHEN THE ENGINE IS VERY HOT. BEFORE THIS OPERATION, MAKE SURE THAT THE THROTTLE GRIP HAS THE RECOMMENDED BACKLASH. IF BACKLASH IN THE THROTTLE CONTROL TRANSMISSION NEEDS ADJUSTING TAKE YOUR SCOOTER TO A PIAGGIO DEALER OR AUTHORISED SERVICE CENTRE**

### Characteristic

#### Engine idle speed

approx. 1600 ÷ 1800 rpm



## Front disc brake (03\_33)

The brake disc and pad wear is automatically compensated, therefore it has no effect on the functioning of the front and rear brakes. For this reason it is not necessary to adjust the brakes. An excessively elastic brake lever stroke may indicate the presence of air in the braking circuit or an irregular brake operation. In this case, particularly considering the importance of the brakes in terms of safety, it is strongly recommended that you take the vehicle to an **Authorised Service Centre** as soon as possible for the appropriate checks.

### WARNING



**CHECK BRAKE PADS FOR WEAR ON A REGULAR BASIS (AS INDICATED IN THE SCHEDULE MAINTENANCE TABLES). IF THE THICKNESS OF ONE OR BOTH PADS IS IN THE REGION OF 1.5 MM, BOTH PADS MUST BE CHANGED. IT IS RECOMMENDED TO CARRY OUT THIS OPERATION AT AN AUTHORISED SERVICE CENTRE AS SOON AS POSSIBLE.**

**AFTER FITTING NEW BRAKE PADS DO NOT USE THE VEHICLE UNTIL YOU HAVE ACTIVATED THE BRAKE LEVER REPEATEDLY TO POSITION THE PADS AND RESTORE THE LEVER STROKE TO ITS CORRECT POSITION.**

### CAUTION



**THE BRAKING ACTION SHOULD BEGIN AFTER ABOUT 1/3 OF THE BRAKE LEVER STROKE.**

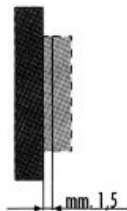

03\_33

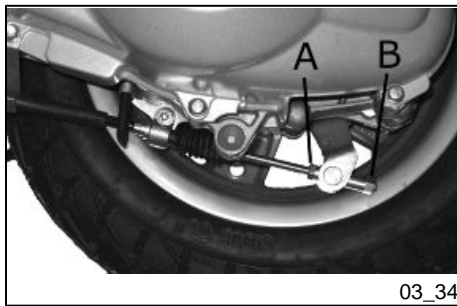

03\_34

### Rear drum brake (03\_34)

Operate adjustment nut «B» and loosen lock nut «A» shown in the figure. Note that when the throttle is in idle **the wheel should rotate free**. After the adjustment, screw lock nut «A».

#### CAUTION



**THE BRAKING ACTION SHOULD BEGIN AFTER ABOUT 1/3 OF THE BRAKE LEVER STROKE.**



03\_35

### Puncture (03\_35)

The vehicle is equipped with Tubeless tyres. When there is a puncture, Tubeless tyres - unlike tyres with inner tubes - go flat very slowly. This offers greater riding safety. A tyre that goes flat very slowly can be repaired with an "Inflate and Repair" spray. Tyres should be later fully repaired or replaced at an **Authorised Service Centre**.



03\_36

### Periods of inactivity (03\_36)

We recommend carrying out the following operations:

1. General cleaning of the vehicle.
- 2 - With the engine off and the piston at bottom dead centre position, remove the spark plug and pour 1÷2 cc of motor oil through its hole. Operate the starter 3-4 times letting the engine perform a few revolutions, then remount the spark plug.
- 3 - Drain up all the vehicle's fuel; spread antirust grease on the unpainted metal parts; keep the wheels lifted above the ground.

4 - For the battery, follow the procedures described in the «Battery» section.

5 - Drain the petrol from the carburettor tank.

6 - Replace engine oil.

### **Recommended products**

#### **AGIP CITY HI TEC 4T**

*Oil to lubricate flexible transmissions (brakes, throttle control and odometer)*

Oil for 4-stroke engines

### **Cleaning the vehicle**

In order to soften the dirt and mud deposited on the painted surfaces, use a low pressure jet of water. Once softened, mud and dirt must be removed with a soft sponge for bodywork soaked in lots of water and "shampoo" (2-4% of car shampoo in water). Then rinse abundantly with water, and dry with a shammy cloth. For the outside of the engine, use petroleum, a brush and clean cloths. Petroleum can damage paintwork. Remember that any polishing with silicone wax must always be preceded by washing

#### **CAUTION**



**DETERGENTS POLLUTE WATER. THEREFORE THE VEHICLE SHOULD BE WASHED IN AN AREA EQUIPPED FOR THE COLLECTION AND PURIFICATION OF THE LIQUIDS USED.**

#### **WARNING**



**NEVER WASH THE VEHICLE UNDER DIRECT SUNLIGHT, ESPECIALLY IN SUMMER WHEN THE BODYWORK IS STILL HOT, AS THE CAR SHAMPOO MAY DRY BEFORE BEING RINSED OFF, AND COULD DAMAGE THE PAINTWORK. NEVER USE RAGS SOAKED IN PETROL OR DIESEL OIL TO CLEAN THE PAINTED OR**

**PLASTIC SURFACES, TO PREVENT THEM LOSING THEIR SHINE AND MECHANICAL CHARACTERISTICS.**

**WARNING**



**WHEN WASHING THE ENGINE WITH A HIGH-PRESSURE WATER JET:**

- **ONLY USE FAN SPRAY JETS.**
- **DO NOT PLACE THE WATER JET NOZZLE CLOSER THAN 60 CM.**
- **DO NOT USE WATER AT TEMPERATURES OVER 40° C.**
- **DO NOT DIRECT THE JETS DIRECTLY TO CARBURETTOR, WIRING, SLOT DIFFUSER ON THE TRANSMISSION COVER AND SCROLL COVER.**

**WARNING**



**CLEAN YOUR SCOOTER FREQUENTLY SO AS TO AVOID POSSIBLE DIRT OR MUD DEPOSITS THAT COULD CAUSE MALFUNCTIONING IN THE THROTTLE GRIP TRANSMISSION AND/OR OTHER COMPONENTS.**

**CLEANING CHROME-PLATED PARTS**

After cleaning chrome-plated parts, polish them with a specific product for chrome-plated, aluminium or stainless steel surfaces. To prevent corrosion, apply a protective spray on all the metal surfaces, including chrome- and nickel-plated ones. Apply spray oil and wax with moderation and make sure to wipe off excess product immediately.

**CAUTION**



**NEVER APPLY OIL AND WAX ON RUBBER AND PLASTIC PARTS.**

**CAUTION**

**CHECK THAT THERE IS NO OIL OR WAX ON THE TYRES. BEFORE USING YOUR SCOOTER TEST ITS BRAKING EFFICIENCY AND BEHAVIOUR ON A BEND.**

**DIFFICULT STARTING**

No fuel in tank	Refuelling
Filters, jets or carburettor dirty or clogged.	Contact an <b>Authorised Service Centre.</b>
Insufficient battery charge	Recharge the battery.

**IGNITION PROBLEM**

No spark from spark plug. Due to the presence of high voltage, this check should only be carried out by an expert.	<p>Check that the electrodes are properly adjusted (0.7÷ 0.8 mm).          Check that the electrodes are clean (clean with pure petrol and metal brush or with emery cloth).          Check the spark plug insulator:          Replace the spark plug if the insulator is cracked or broken. If the spark plug is in good conditions, contact an <b>Authorised Service Centre.</b></p>
--	--

### LACK OF COMPRESSION

Spark plug adapter "worn", valve clearance not adequate; worn piston gas rings	Contact an <b>Authorised Service Centre</b> .
--	---

### HIGH CONSUMPTION AND LOW PERFORMANCE

Air filter blocked or dirty.	Clean with water and shampoo and impregnate with petrol and specific oil (section «Removing the air filter»)
------------------------------	--

### INEFFICIENT BRAKING

Oil on drum or disc. Worn Pads/ Shoes	Contact an <b>Authorised Service Centre</b>
incorrect rear brake adjustment	Adjust

### INEFFICIENT SUSPENSIONS

Inefficient shock absorbers, oil leakage, deteriorated end of stroke buffers.	Contact an <b>Authorised Service Centre</b>
---	---

### IRREGULAR AUTOMATIC TRANSMISSION

Deteriorated variable speed rollers and/or driving belt and/or clutch	Contact an <b>Authorised Service Centre</b>
---	---

### EXHAUST NOISE

Depression tube damaged/ disconnected or secondary valve damaged	Contact an <b>Authorised Service Centre</b>
--	---

### STAND DOES NOT RETURN TO POSITION

Presence of dirt	Clean and grease
------------------	------------------





# Vespa LXV 125

**Vespa®**



**Chap. 04**  
**Technical data**

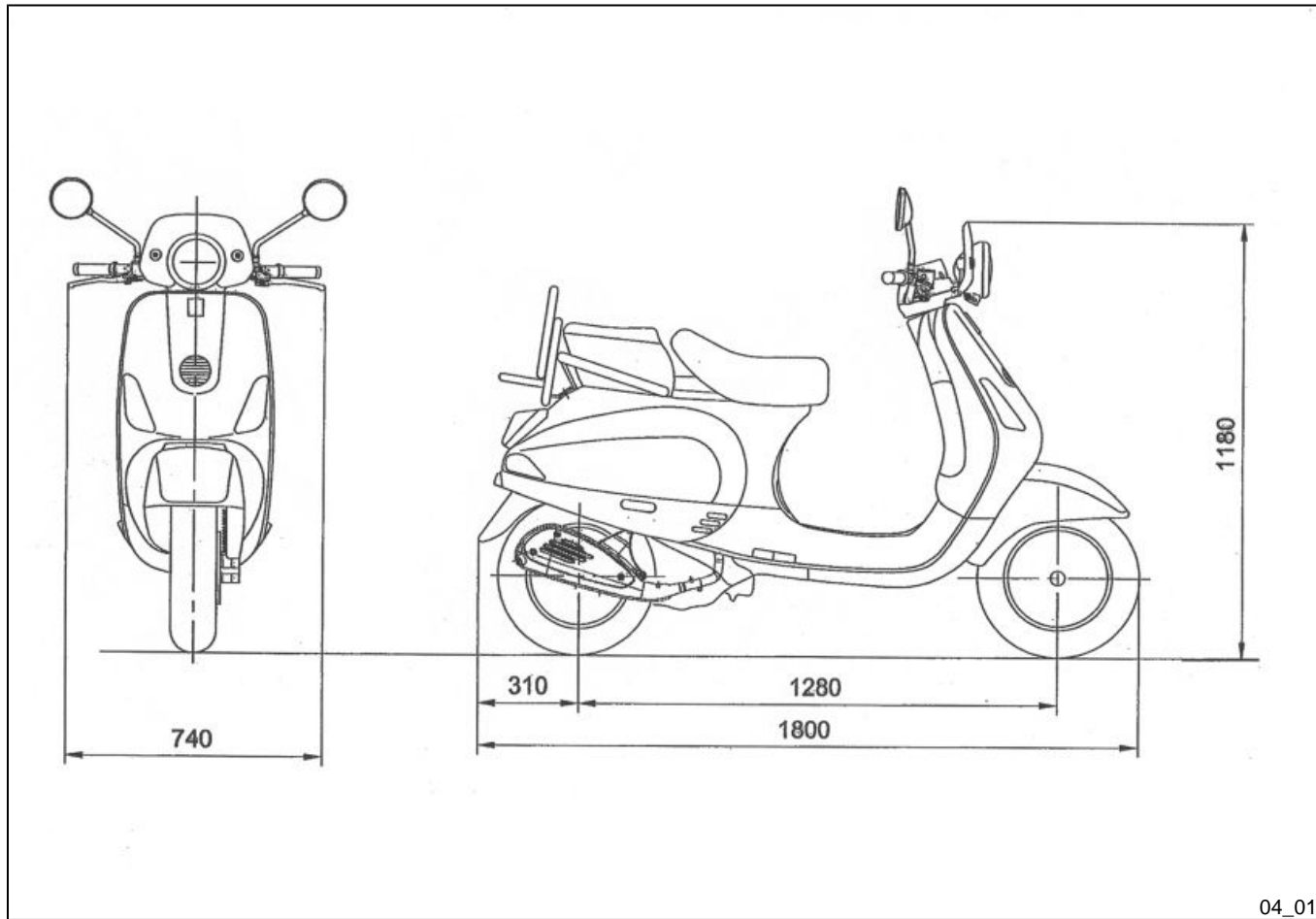

**TECHNICAL DATA**

Engine	Single-cylinder, 4-stroke Piaggio LEADER
Cubic capacity	124 cc
Bore x stroke	57.0 x 48.6 mm
Length	1800 mm
Width	740 mm
Wheelbase	1280 mm
Overall height	1180 mm
Spark plug	CHAMPION RG6YC - NGK CR7EB
Carburettor	KEIHIN CVK26
Valve clearance	intake 0.10 outlet 0.15
Fuel	Unleaded petrol
Fuel tank capacity	~ 8.5 l (2 l of which is reserve)
Timing system	Single overhead camshaft (SOHC) with 2 valves
Cooling	Forced air circulation.
Lubrication	Wet crankcase
Start-up	Electric
Transmission	Automatic speed variator CVT with torque server

Chassis	Unitised body made of stamped plate.
Clutch	Automatic centrifugal dry clutch
Steering and suspensions	Steering tube articulated on the front wheel carrier hub; helicoidal spring suspension and double-acting hydraulic shock absorber; rear with double-acting shock absorber and coaxial spring adjustable to 4 positions at preloading.
Front brake	Disc brake (Ø 200 mm) with hydraulic control (lever on the far right of the handlebar) and fixed calliper.
Rear brake	Ø110 mm drum brake
Front wheel rim	Die-cast aluminium alloy; 2.50 x11"
Rear wheel rim	Die-cast aluminium alloy; 3.00 x 10"
Front tyre	Tubeless; 110/70-11"
Rear tyre	Tubeless; 120/70-10"
Kerb weight	114 ± 5 kg
Maximum admitted weight	~ 300 Kg

### Kit equipment

Wrenches: box-spanner (16 mm); one twin screwdriver; one spanner for sock absorbers. The tools are located under the seat in an appropriate container.

# Vespa LXV 125

**Vespa®**



**Chap. 05  
Spare parts and  
accessories**



## Warnings (05\_01)

### WARNING



IT IS ALSO RECOMMENDED THAT "ORIGINAL PIAGGIO SPARE PARTS" BE USED, AS THESE ARE THE ONLY ONES OFFERING YOU THE SAME QUALITY ASSURANCE AS THOSE INITIALLY FITTED ON THE VEHICLE.

IT SHOULD BE REMEMBERED THAT USING NON-ORIGINAL SPARE PARTS CAUSES YOUR WARRANTY RIGHTS TO EXPIRE.

### WARNING



PIAGGIO MARKETS ITS OWN LINE OF ACCESSORIES THAT ARE RECOGNISED AND GUARANTEED FOR USE. IT IS THEREFORE ESSENTIAL, IN ORDER TO CHOOSE AND MOUNT THE ACCESSORIES CORRECTLY, TO CONTACT AN AUTHORISED DEALER OR SERVICE CENTRE. THE USE OF NON-ORIGINAL ACCESSORIES MAY AFFECT THE STABILITY AND OPERATION OF YOUR VEHICLE AND REDUCE SAFETY LEVELS WITH POTENTIAL RISKS FOR THE RIDER.

# Vespa LXV 125

**Vespa®**



**Chap. 06  
Programmed  
maintenance**

## Scheduled maintenance table

Adequate maintenance is fundamental to ensuring long-lasting, optimum operation and performance of your vehicle.

To this end, a series of checks and maintenance operations (at the owner's expense) have been suggested, which are included in the summary table on the following page. Any minor faults should be reported without delay to an **Authorised Service Centre or Dealer** without waiting until the next scheduled service to solve it.

All scheduled maintenance services must be carried out at the specified times, even if the stated mileage has not yet been reached. Carrying out scheduled services on time is necessary to ensure your warranty remains valid. For any further information concerning Warranty procedures and "Scheduled Maintenance", please refer to the "Warranty Booklet".

### EVERY 2 YEARS

Brake fluid - change
----------------------

### EVERY 3000 KM

Engine oil - level check/ top-up
----------------------------------

### AFTER 1000 KM

Engine oil - replacement
--------------------------

Hub oil - change
------------------

Oil filter (net filter) - clean
---------------------------------

Idle speed (*) - adjustment
-----------------------------



Throttle lever - adjustment

Steering - adjustment

Brake control levers - greasing

Brake pads - check condition and wear

Brake fluid level - check

Safety locks - check

Electrical system and battery - check

Tyre pressure and wear - check

Vehicle and brake test - road test

(\*) See instructions in «Idle speed adjustment» section

### **AFTER 6000 KM, 18000 KM, 54000 KM**

Engine oil - replacement

Hub oil level - check

Spark plug electrode gap - check

Air filter - clean

Engine oil - change

Oil filter (net filter) - clean

Valve clearance - adjustment

Variable speed rollers/pads - check

Driving belt - check

Brake pads - check condition and wear

Brake fluid level - check

Electrical system and battery - check

Centre stand - lubrication

Tyre pressure and wear - check

Vehicle and brake test - road test

### **AFTER 12000 KM, 60000 KM**

Engine oil - replacement

Hub oil level - check

Air filter - clean

Engine oil - change

Oil filter (net filter) - clean

Spark plug - replacement

Idle speed (\*) - adjustment

Throttle lever - adjustment

Pads and variator rollers - replacement

Driving belt - replacement

Odometer cable - greasing

Steering - adjustment

Brake control levers - greasing

Brake pads - check condition and wear

Brake fluid level - check

---

Transmission elements - lubrication

---

Safety locks - check

---

Suspensions - check

---

Electrical system and battery - check

---

Headlight - adjustment

---

Centre stand - lubrication

---

Secondary air filter - cleaning

---

Tyre pressure and wear - check

---

Vehicle and brake test - road test

---

*(\*) See instructions in «Idle speed adjustment» section*

### **AFTER 24000 KM, 48000 KM**

---

Engine oil - replacement

---

Hub oil - change

---

Air filter - clean

---

Engine oil - change

---

Oil filter (net filter) - clean

---

Spark plug - replacement

---

Idle speed (\*) - adjustment

---

Throttle lever - adjustment

---

Pads and variator rollers - replacement

---

Driving belt - replacement

---

Cylinder ventilation system - cleaning

Odometer cable - greasing

Steering - adjustment

Brake control levers - greasing

Brake pads - check condition and wear

Brake fluid level - check

Transmission elements - lubrication

Safety locks - check

Suspensions - check

Electrical system and battery - check

Headlight - adjustment

Tyre pressure and wear - check

Secondary air filter - cleaning

Centre stand - lubrication

Vehicle and brake test - road test

(\*) See instructions in «Idle speed adjustment» section

### **AFTER 30000 KM, 42000 KM, 66000 KM**

Engine oil - replacement

Hub oil level - check

Spark plug electrode gap - check

Air filter - clean

Engine oil - change

Oil filter (net filter) - clean

Slide pads and variator rollers - check

Driving belt - check

Brake pads - check condition and wear

Brake fluid level - check

Electrical system and battery - check

Centre stand - lubrication

Tyre pressure and wear - check

Vehicle and brake test - road test

### **AFTER 36000 KM**

Engine oil - replacement

Hub oil - change

Spark plug - replacement

Air filter - clean

Engine oil - change

Oil filter (net filter) - clean

Valve clearance - adjustment

Idle speed (\*) - adjustment

Throttle lever - adjustment

Pads and variator rollers - replacement

Driving belt - replacement

Odometer cable - greasing

Steering - adjustment

Brake control levers - greasing

Brake pads - check condition and wear

Brake fluid level - check

Flexible brake tubes - replacement

Transmission elements - lubrication

Safety locks - check

Suspensions - check

Electrical system and battery - check

Headlight - adjustment

Secondary air filter - cleaning

Centre stand - lubrication

Tyre pressure and wear - check

Vehicle and brake test - road test

*(\*) See instructions in «Idle speed adjustment» section*

### **AFTER 72,000 KM**

Engine oil - replacement

Hub oil - change

Spark plug - replacement

---

Air filter - clean

---

Engine oil - change

---

Oil filter (net filter) - clean

---

Valve clearance - adjustment

---

Idle speed (\*) - adjustment

---

Throttle lever - adjustment

---

Pads and variator rollers - replacement

---

Driving belt - replacement

---

Odometer cable - greasing

---

Steering - adjustment

---

Cylinder ventilation system - check

---

Brake control levers - greasing

---

Brake pads - check condition and wear

---

Brake fluid level - check

---

Flexible brake tubes - replacement

---

Transmission elements - lubrication

---

Safety locks - check

---

Suspensions - check

---

Electrical system and battery - check

---

Headlight - adjustment

---

Secondary air filter - cleaning

---

Centre stand - lubrication

---

Tyre pressure and wear - check

---

(\*) See instructions in «Idle speed adjustment» section

### RECOMMENDED PRODUCTS TABLE

Product	Description	Specifications
AGIP ROTRA 80W-90	Rear hub oil	SAE 80W/90 Oil that exceeds the requirements of API GL3 specifications
AGIP BRAKE 4	Brake fluid	FMVSS DOT 4 Synthetic fluid
AGIP CITY HI TEC 4T	Oil to lubricate flexible transmissions (brakes, throttle control and odometer)	Oil for 4-stroke engines
AGIP FILTER OIL	Oil for air filter sponge	Mineral oil with specific additives for increased adhesiveness
AGIP CITY HI TEC 4T	Engine oil	SAE 5W-40, API SL, ACEA A3, JASO MA Synthetic oil
AGIP GREASE MU3	Grease for odometer transmission gear case	Soap-based lithium grease with NLGI 3; ISO-L-XBCHA3, DIN K3K-20
AGIP GP 330	Grease for brake control levers, throttle, stand	White calcium complex soap-based spray grease with NLGI 2; ISO-L-XBCIB2



# TABLE OF CONTENTS

## **A**

Air filter: 36

## **B**

Battery: 39

Brake: 38, 49, 50

## **D**

Disc brake: 49

## **E**

Engine oil: 30, 31

Engine stop: 13

## **F**

Fuses: 41

## **H**

Headlight: 44

Horn: 12

Hub oil: 32

## **I**

Identification: 17

Immobilizer: 13, 15

Instrument panel: 10

## **K**

Key switch: 11

Keys: 13

## **L**

Light switch: 12

## **M**

Maintenance: 29, 63, 64

Mirrors: 47

## **S**

Saddle: 16, 17

Scheduled maintenance: 64

Shock absorbers: 22

Spark plug: 35

Start-up: 13

## **T**

Technical Data: 57

Top box: 18

Transmission: 26

Turn indicators: 46

Tyre pressure: 21

Tyres: 34



The descriptions and illustrations given in this publication are not binding. While the basic features as described and illustrated in this manual remain unchanged, PIAGGIO - GILERA reserves the right, at any time and without being required to update this publication beforehand, to make any changes to components, parts or accessory supplies, which it considers necessary to improve the product or which are required for manufacturing or construction reasons.

Not all versions shown in this publication are available in all Countries. The availability of individual versions should be confirmed with the official Piaggio sales network.

"© Copyright 2007 - PIAGGIO & C. S.p.A. Pontedera. All rights reserved. Reproduction of this publication in whole or in part is prohibited."

PIAGGIO & C. S.p.A. - After-Sales

V.le Rinaldo Piaggio, 23 - 56025 PONTEDERA (Pi)