

Vespa would like to thank you

for choosing one of its products. We have prepared this manual to help you to get the very best from your vehicle. Please read it carefully before riding the vehicle for the first time. It contains information, tips and precautions for using your vehicle. It also describes features, details and devices to assure you that you have made the right choice. We believe that if you follow our suggestions, you will soon get to know your new scooter and it will serve you well for a long time to come. This booklet forms an integral part of the vehicle; should the vehicle be sold, it must be transferred to the new owner.

VESPA PRIMAVERA 50 2T



The instructions given in this manual are intended to provide a clear, simple guide to using your vehicle; this booklet also details routine maintenance procedures and regular checks that should be carried out on the vehicle at an **authorised Dealer or Service Centre**. The booklet also contains instructions for simple repairs. Any operations not specifically described in this booklet require the use of special tools and/or particular technical knowledge: to carry out these operations, refer to any **authorised Dealer or Service Centres**.



Personal safety

Failure to completely observe these instructions will result in serious risk of personal injury.



Safeguarding the environment

Sections marked with this symbol indicate the correct use of the vehicle to prevent damaging the environment.



Vehicle intactness

The incomplete or non-observance of these regulations leads to the risk of serious damage to the vehicle and sometimes even the invalidity of the guarantee.

The signs that you see on this page are very important. They are used to highlight parts of the booklet that should be read with particular care. The different symbols are used to make each topic in the manual simple and quick to locate.

INDEX

VEHICLE..... 7

- Dashboard..... 8
- Analogue instrument panel..... 9
- Digital lcd display..... 11
 - Setting the hour/minutes function..... 12
 - *MODE* button..... 13
- Keyswitch..... 13
 - Locking the steering wheel..... 14
 - Releasing the steering wheel..... 14
- Switch direction indicators..... 15
- Horn button..... 15
- Light switch..... 16
- Start-up button..... 16
- Fuel tank..... 17
- Mixture oil reservoir..... 18
 - Opening the saddle..... 18
- Opening the side panels..... 19
- Keys..... 20
- Identification..... 20
- Rear top box opening..... 21
- Bag clip..... 22

USE..... 23

- Checks..... 24
- Refuelling..... 24
- Tyre pressure..... 27
- Running in..... 28
- Starting up the engine..... 28
- Difficult start up..... 30
- Stopping the engine..... 31
- Catalytic silencer..... 31
- Stand..... 32
- Automatic transmission..... 33
- Safe driving..... 33

MAINTENANCE..... 37

- Hub oil level..... 38
- Tyres..... 39
- Spark plug dismantlement..... 40
- Removing the air filter..... 41
- Secondary air system..... 42
- Checking the brake oil level..... 42
 - Braking system fluid top up..... 43
- Battery..... 45
 - Use of a new battery..... 46
 - Checking the electrolyte level..... 47
- Long periods of inactivity..... 47
- Fuses..... 49
- Front light group..... 51
 - Head light adjustment..... 53
- Front direction indicators..... 54
- Rear optical unit..... 55
- Rear turn indicators..... 56
- Rear-view mirrors..... 57
- Idle adjustment..... 57
- Front disc brake..... 58
- Rear drum brake..... 59
- Puncture..... 60
- Inactivity of the vehicle..... 60
 - Cleaning the vehicle..... 61

TECHNICAL DATA..... 67

- Data..... 68
- Tool kit..... 71

SPARE PARTS AND ACCESSORIES..... 73

- Warnings..... 74

SCHEDULED MAINTENANCE..... 75

- Scheduled servicing table..... 76

VESPA PRIMAVERA 50 2T

Vespa®



**Chap. 01
Vehicle**

Dashboard (01_01)

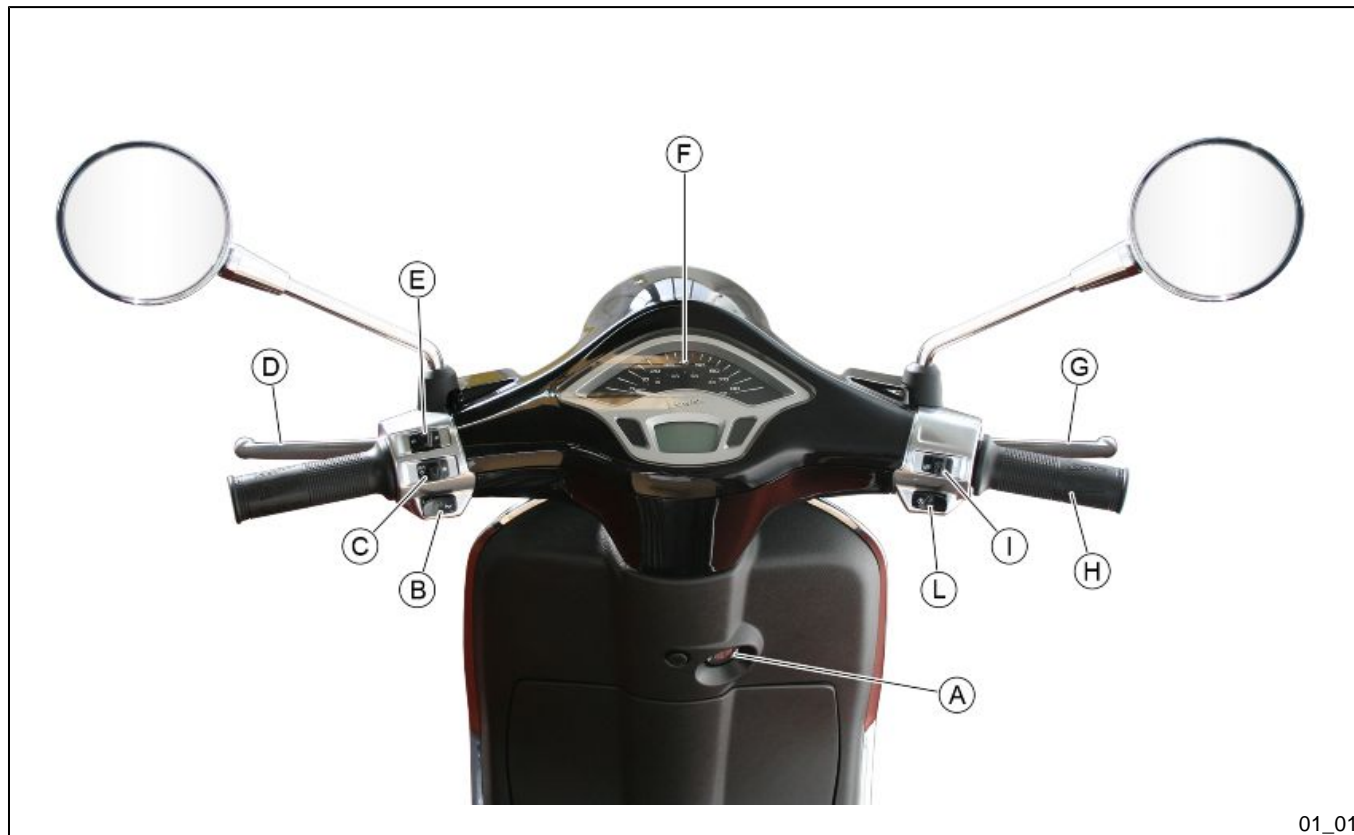

01_01

A = Ignition switch

B = Horn button

C = Turn indicator switch

D = Rear brake lever

E = Light switches

F = Instrument panel

G = Front brake lever

H = Throttle grip

I = MODE button

L = Start-up button

Analogue instrument panel (01_02)

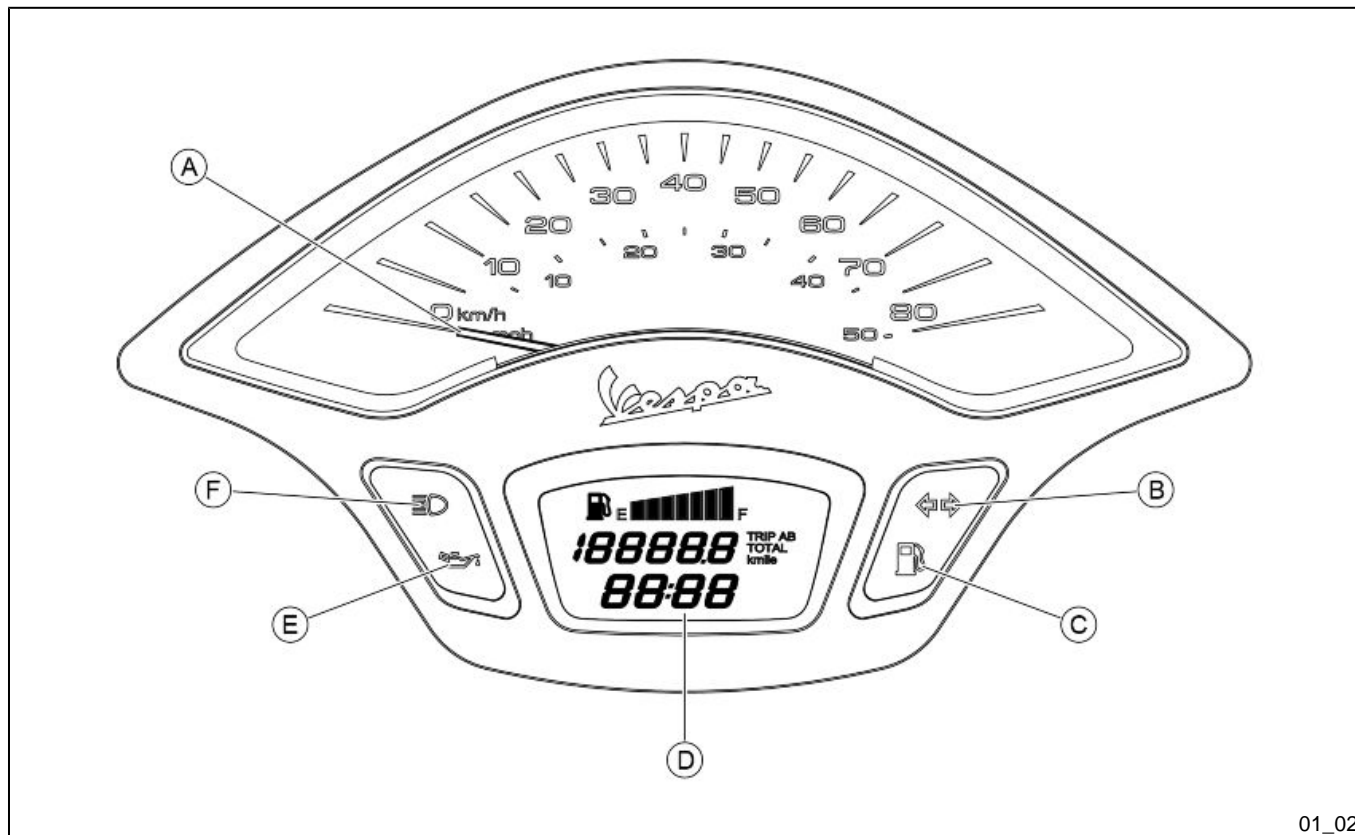

01_02

A = Speedometer

B = Turn indicator warning light

C = Fuel reserve warning light

D = Digital display

E= Mixer low oil warning light

F = High-beam warning light

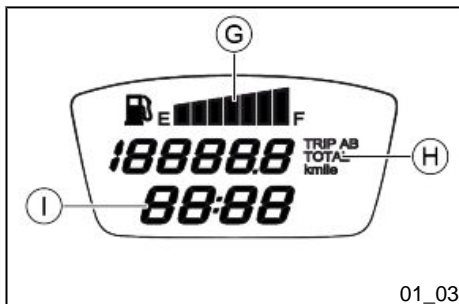

Digital lcd display (01_03)

G = Fuel gauge with petrol symbol

H = Total and partial odometer

I = Clock

By turning the ignition key to the «**ON**» position all the digital display functions will light up for a few seconds.

TOTAL AND PARTIAL ODOMETER «H»

Acting on the MODE button this indicator displays the following functions in sequence:

- Total odometer (TOTAL)
- Partial odometer A (TRIP A)
- Partial odometer B (TRIP B)

The unit of measurement can be changed (from Km to Miles) with the following procedure:

- turn the key to the «**OFF**» position;

- press the MODE button;
- Holding in the MODE button, turn the key to the «ON» position;
- after about 2 seconds release the MODE button.

N.B.

THE NAVIGATION OF THE DISPLAY DEFINES:

- «SHORT PRESS»: PRESSING THE BUTTON INDICATED FOR LESS THAN TWO SECONDS;
- «LONG PRESS»: PRESSING THE BUTTON INDICATED FOR MORE THAN TWO SECONDS.

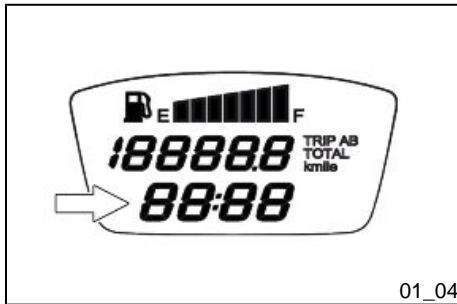

Setting the hour/minutes function (01_04)

To set or adjust the clock, with vehicle running or with key inserted in «ON» position, proceed as follows:

- short press the MODE button in sequence until the total odometer appears on the display;
- long press to enter the hour display;
- adjust the hour by short pressing the MODE button;
- with a long press, the set value is confirmed (or present value if not modified) and it goes on to the minutes display.
- adjust the minutes by short pressing the MODE button;
- with a long press, the set value is confirmed (or present value if not modified) and the set or changed time will be displayed.

WARNING

FOR SAFETY REASONS THE TIME SETTING IS ONLY POSSIBLE WITH THE VEHICLE AT A STANDSTILL.

WARNING

DISCONNECTING THE BATTERY CABLES WILL RESULT IN A RESET OF THE CLOCK WHICH WILL INDICATE "12:00" UNTIL THE TIME IS SET AGAIN.

***MODE* button (01_05)**

With the vehicle on or with the key in the «**ON**» position, short press the MODE button «**I**», to change the odometer display (TOTAL, TRIP A, TRIP B).

With a long press of the MODE button, the following is possible:

- on the TOTAL screen page, proceed with clock adjustment;
- on the TRIP A or TRIP B screen page, reset the relative counter.

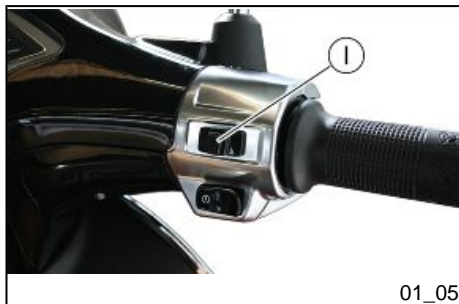

01_05

Keyswitch (01_06)

The key switch «**A**» is located on the knee-guard panel.

SWITCH POSITIONS

ON «1»: Ready to start position, non-extractable key, mechanical antitheft device disabled.

OFF «2»: Ignition disabled, extractable key, mechanical antitheft device disabled.

LOCK «3»: Ignition disabled, extractable key, mechanical antitheft device enabled.



01_06



Locking the steering wheel (01_07)

Turn the handlebar to the left (as far as it will go), turn the key to «**LOCK**» and remove the key.

CAUTION



NEVER TURN THE KEY TO «LOCK» OR «OFF» WHILE RIDING.



Releasing the steering wheel (01_08)

Reinsert the key and turn it to «**OFF**».

CAUTION



NEVER TURN THE KEY TO «LOCK» OR «OFF» WHILE RIDING.

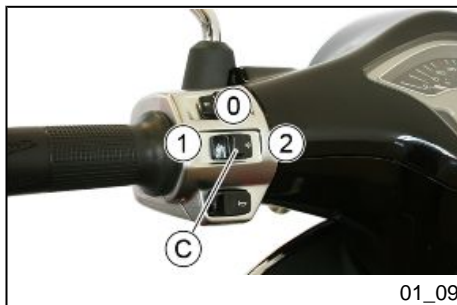

Switch direction indicators (01_09)

The left turn indicators turn on by moving the turn indicator switch «C» to the left, to position «1».

The right turn indicators turn on by moving the switch «C» to the right, to position «2».

The turn indicator switch «C» turns automatically to position «0», keeping the requested function.

To cancel the request and turn off the activated indicators, press the switch button «C».

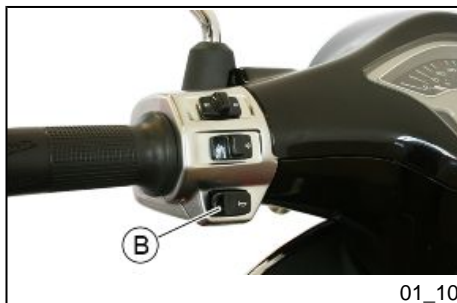

Horn button (01_10)

Push the button «B» to sound the horn.

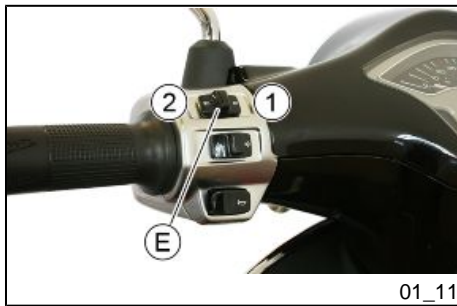

Light switch (01_11)

When the light switch «E» is set to «1», the low-beam light is on. When set to «2», the high-beam light is activated.

CAUTION



DO NOT PLACE, TRANSPORT OBJECTS AND/OR CLOTHES OVER THE FRONT HEADLIGHT ASSEMBLY, WHEN THE HEADLIGHT IS TURNED ON OR OFF. FAILURE TO FOLLOW THIS PRECAUTION MAY CAUSE OVERHEATING AND THE SUBSEQUENT FUSION OF THE GLASS.

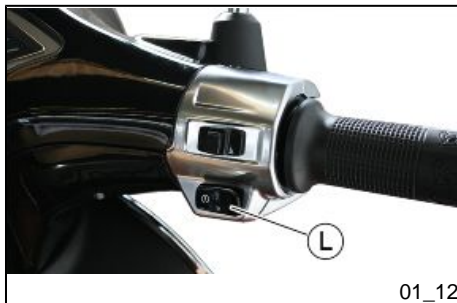

Start-up button (01_12)

To start the engine, pull either of the two brake levers and then push the button «L».

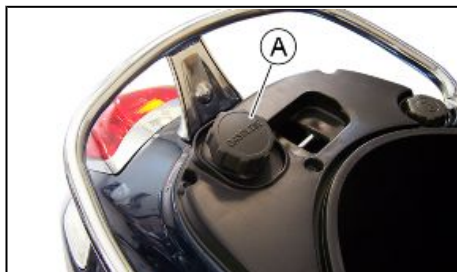

01_13

Fuel tank (01_13)

The fuel tank cap «A» is under the saddle. To reach it, tip the saddle forwards.

CAUTION



DURING THE FUEL REFUELLING, AVOID THE USE OF ELECTRONIC DEVICES AND/OR CELLULAR PHONES, WHICH MAY CAUSE FIRE FROM FUEL VAPOURS WITH POSSIBLE DAMAGE TO OBJECTS AND/OR PERSONAL INJURIES.

CAUTION

WARNING



DURING REFUELLING INSERT THE NOZZLE ALL THE WAY INTO THE TANK. AT THE FIRST STOP INTERRUPT FUELLING AND DO NOT CONTINUE FILLING IN ORDER TO PREVENT FUEL SPILLS WHICH MAY OCCUR EVEN AFTER REFUELLING.

CAUTION



DURING THE REFUELLING, AVOID FUEL LEAKAGE WHICH MAY CAUSE DAMAGE TO OBJECTS AND/OR PERSONAL INJURIES AND FIRE HAZARD.

N.B.

WITH THE VEHICLE STOPPED AND THE ENGINE HOT A BRIEF NOISE MAY OCCUR REPEATED AT REGULAR INTERVALS UNTIL THE ENGINE COOLS.

THIS IS NOT A MALFUNCTION BUT IS RATHER THE NORMAL BEHAVIOUR OF VALVES WHICH ARE PRESENT ON THE VEHICLE.

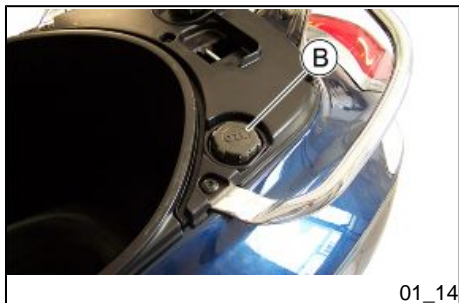

Mixture oil reservoir (01_14)

The oil mix tank cap «B» is under the saddle. To reach it, insert the key into the saddle lock, turn it anticlockwise and tip the saddle forwards.

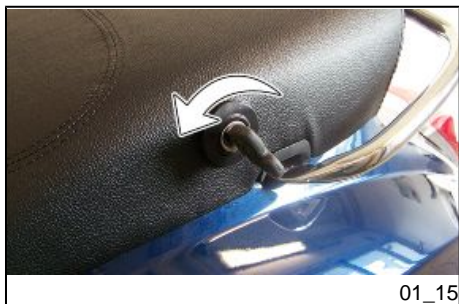

Opening the saddle (01_15)

Insert the key into the saddle lock and turn it anticlockwise to open it.

When lifting the saddle, you access the:

- fuel tank cap,
- oil mix tank cap;
- helmet compartment.

Opening the side panels (01_16, 01_17, 01_18)

To remove the front cover, proceed as follows:

- remove the clip-on badge, paying attention to the vehicle bodyworks.



01_16



01_17

- Undo the fixing screw.
- Turn the handlebar until the end of one side.
- Remove the front cover towards the base, releasing the housing tongues.



01_18

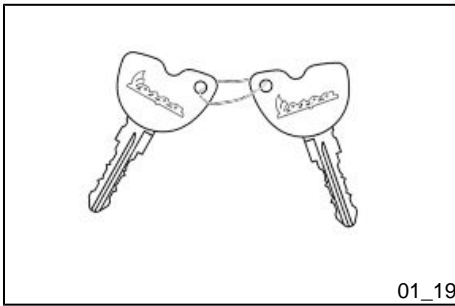

Keys (01_19)

The vehicle is supplied with two keys (one spare) which serve to start the engine and unlock the saddle compartment. The keys are accompanied by a tag marked with the identification code to be quoted when ordering duplicates.

WARNING

WE RECOMMEND KEEPING THE DUPLICATE KEY TOGETHER WITH ITS CODE IN A SAFE PLACE AND NOT ON THE VEHICLE

Identification (01_20, 01_21)

Identification registration numbers are made up of a prefix and a number, stamped on the chassis and on the engine. These numbers must always be quoted when ordering spare parts. We recommend checking that the chassis registration number stamped on the vehicle corresponds with that on the vehicle documentation.

CAUTION



PLEASE REMIND THAT ALTERING IDENTIFICATION REGISTRATION NUMBERS CAN LEAD TO SERIOUS PENAL SANCTIONS (IMPOUNDING OF THE VEHICLE, ETC.).



01_20

Chassis number

The chassis number «A» is stamped near the fuel tank.

To read it, proceed as follows:

- lift the saddle;
- lift the helmet compartment by removing it.

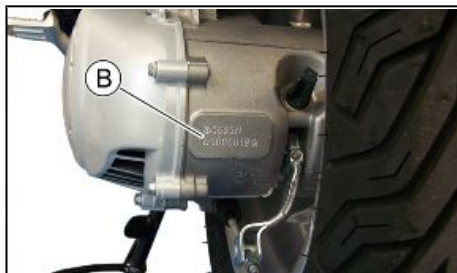

01_21

Engine number

The engine number «B» is stamped near the rear left shock absorber lower support.



01_22

Rear top box opening (01_22)

With the key in position «OFF» or «ON», press it to open the case. When the key is set to «LOCK», the glove-box is locked.



Bag clip (01_23)

The bag hook is placed on the saddle end.

To use the hook, slide it off from the front.



Maximum applicable load: 1.5 kg



FOR THE USER SAFETY, THE DIMENSIONS OF THE LOAD SHOULD NOT BE EXCEEDED BY THE PERIMETER OF THE VEHICLE OR PREVENT AT ALL THE RIDING.

VESPA PRIMAVERA 50 2T

Vespa®



Chap. 02
Use

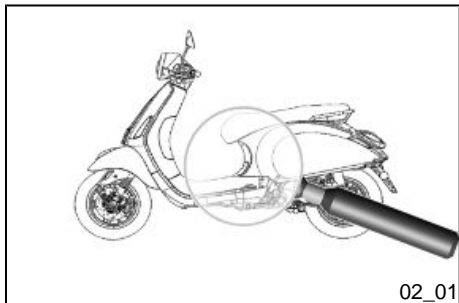

Checks (02_01)

Before using the vehicle, check:

1. That the petrol tank and the oil reservoir are full.
2. Rear hub oil level.
3. That the tyres are properly inflated.
4. The correct functioning of headlights, rear light and turn indicators.
5. The correct functioning of front and rear brakes.
6. The fluid level in the brake pump reservoir.

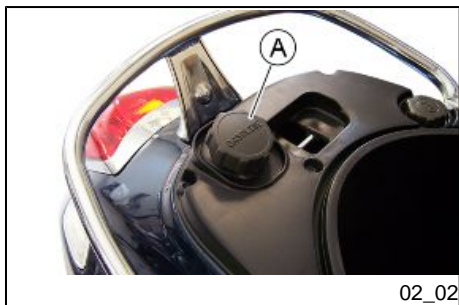

Refuelling (02_02, 02_03)

Fill the fuel tank «A» with unleaded petrol with a minimum octane rating of 95.

The rider is informed when fuel is low by the fuel warning light on the instrument panel (see the "Dashboard" section).

Top up oil tank «B» using recommended oil. The oil warning light on the instrument panel turns on to signal oil minimum level (see "Dashboard" section).

Should this warning light turn on, the oil tank should be topped-up at the following refuelling and in any case before travelling another 150 km.

When turning the key to «ON», the oil warning light turns on for a few seconds indicating the correct functioning of the bulb and oil reserve circuit.

If the warning light fails to come on, it is faulty. Should this happen, contact an **Authorised Service Centre**.

CAUTION



SHUT OFF THE ENGINE BEFORE REFUELLING WITH PETROL. PETROL IS HIGHLY FLAMMABLE. DO NOT LET PETROL SPILL FROM THE TANK OR WHILE REFUELLING

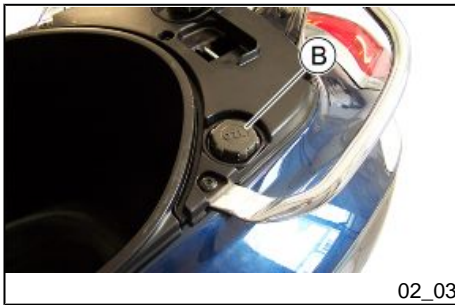

02_03

CAUTION



DO NOT BRING NAKED FLAMES OR CIGARETTES NEAR THE MOUTH OF THE FUEL TANK: FIRE HAZARD. ALSO AVOID INHALING HARMFUL VAPOURS.



IMPORTANT: NEVER EMPTY THE MIXER OIL RESERVOIR.

CAUTION



THE USE OF OILS AND SPARK PLUGS OTHER THAN THOSE RECOMMENDED CAN SHORTEN THE LIFE OF THE ENGINE.

CAUTION



DURING THE FUEL REFUELLING, AVOID THE USE OF ELECTRONIC DEVICES AND/OR CELLULAR PHONES, WHICH MAY CAUSE FIRE FROM FUEL VAPOURS WITH POSSIBLE DAMAGE TO OBJECTS AND/OR PERSONAL INJURIES.

CAUTION

WARNING



DURING REFUELLING INSERT THE NOZZLE ALL THE WAY INTO THE TANK. AT THE FIRST STOP INTERRUPT FUELLING AND DO NOT CONTINUE FILLING IN ORDER TO PREVENT FUEL SPILLS WHICH MAY OCCUR EVEN AFTER REFUELLING.

CAUTION



DURING THE REFUELLING, AVOID FUEL LEAKAGE WHICH MAY CAUSE DAMAGE TO OBJECTS AND/OR PERSONAL INJURIES AND FIRE HAZARD.

Recommended products

eni i-Ride PG 2s

*Synthetic based lubricant for low smoke 2-stroke engines and additives.
API TC - JASO FC - ISO-L-EGD*

Characteristic

Fuel tank capacity

6.4 ± 0.1 l

Oil mix tank capacity

~ 1.3 l

N.B.

WITH THE VEHICLE STOPPED AND THE ENGINE HOT A BRIEF NOISE MAY OCCUR REPEATED AT REGULAR INTERVALS UNTIL THE ENGINE COOLS. THIS IS NOT A MALFUNCTION BUT IS RATHER THE NORMAL BEHAVIOUR OF VALVES WHICH ARE PRESENT ON THE VEHICLE.

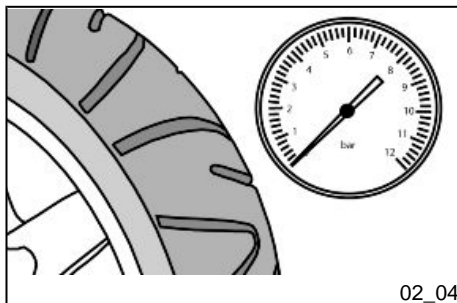

Tyre pressure (02_04)

Check tyre pressure as indicated in the scheduled maintenance table.

CAUTION



TYRE PRESSURE SHOULD BE CHECKED WHEN TYRES ARE COLD. INCORRECT TYRE PRESSURE CAUSES ABNORMAL TYRE WEAR AND MAKES RIDING DANGEROUS.

TYRES MUST BE REPLACED WHEN THE TREAD REACHES THE WEAR LIMITS SET FORTH BY LAW.

TYRE INFLATION PRESSURE

Front tyre pressure	1.6 bar
Rear tyre pressure	1.8 bar

TYRES

Front tyre	Tubeless, 110/70 - 11" 45L
Rear tyre	Tubeless, 120/70 - 11" 56L

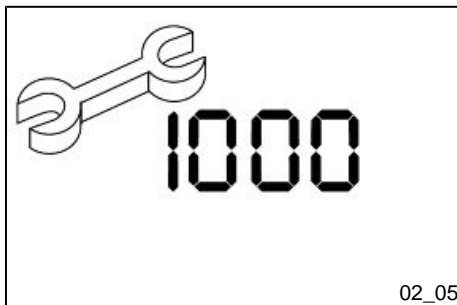

02_05

Running in (02_05)

WARNING



DURING THE FIRST 1000 KM DO NOT RIDE THE VEHICLE OVER 80% OF ITS MAXIMUM SPEED. AVOID TWISTING THE THROTTLE GRIP FULLY OR KEEPING A CONSTANT SPEED ALONG LONG SECTIONS OF ROAD. AFTER THE FIRST 1000 KM, GRADUALLY INCREASE SPEED UNTIL REACHING THE MAXIMUM PERFORMANCE.



02_06

Starting up the engine (02_06, 02_07, 02_08, 02_09)

The vehicle is fitted with automatic transmission with a regulator and centrifugal clutch. Therefore always start the engine with the throttle at idle speed; to start-off from stationary position, progressively twist the throttle grip.

The vehicle is equipped with a fuel valve and a starter which switch on automatically as soon as the engine is started.

To start it up, it is necessary to:

- Rest the vehicle on its centre stand, ensuring the rear wheel is not touching the ground.
- Insert the key into the ignition switch and turn it to « **ON** ».
- After pulling the front brake lever « **B** » or the rear brake lever « **C** », push the starter button « **A** » by slightly and gradually turning the throttle grip.

CAUTION



DO NOT CARRY OUT THESE OPERATIONS IN CLOSED AREAS SINCE EXHAUST GASES ARE TOXIC.



02_07

CAUTION



DUE TO THE HIGH TEMPERATURES THE CATALYTIC CONVERTER CAN REACH, ALWAYS TAKE CARE, WHEN PARKING THE VEHICLE, THAT THE SILENCER DOES NOT COME INTO CONTACT WITH FLAMMABLE MATERIALS, TO AVOID SERIOUS BURNS.



02_08



02_09



02_10

Difficult start up (02_10)

If there is a problem you can follow the instructions below:

1. Flooded engine

Place the vehicle on its centre stand and check that the rear wheel is off the ground. Open the throttle fully and press the starter button for five seconds and then stop for five seconds. If the engine does not start after a few attempts, let the engine sit for a few minutes and then repeat the above operations. In any case do not operate the starter motor longer than 20" in an attempt to start the engine.

2. Battery or starter motor inefficiency

Place the vehicle on its stand; make sure that the rear wheel is off the ground, turn the ignition switch to the «ON» position and use the kick-starter **D**.

3. Empty fuel tank

After refuelling the vehicle, start the engine by pressing the starter button with the throttle at a minimum to provide maximum aspiration for the tap. If the vehicle fails to start even after carrying out the steps described above, contact an **Authorised Service Centre**.

CAUTION



ALWAYS PLACE THE VEHICLE ON ITS STAND BEFORE KICK STARTING.

WARNING



TAMPERING MAY CAUSE SERIOUS ENGINE MALFUNCTION.



02_11

Stopping the engine (02_11)

After having stopped the vehicle, with the accelerator throttle grip fully closed, turn the key to **OFF** (removable key).

CAUTION



DUE TO THE HIGH TEMPERATURES THAT CAN BE REACHED IN THE CATALYTIC CONVERTER, WHEN PARKING THE VEHICLE, PAY ATTENTION TO THE MUFFLER: TO AVOID SERIOUS BURNS OR FIRE, THE MUFFLER SHOULD NEVER COME INTO CONTACT WITH FLAMMABLE MATERIALS.

CAUTION



DO NOT SHUT OFF THE ENGINE WHILE THE VEHICLE IS MOVING. UNBURNED FUEL COULD ENTER THE CATALYTIC CONVERTER AND BURN, CAUSING THE CONVERTER TO OVERHEAT AND POSSIBLY DESTROYING IT.



02_12

Catalytic silencer (02_12)

CAUTION



TAMPERING WITH THE CATALYTIC SILENCER MAY CAUSE SEVERE DAMAGE TO THE ENGINE.

CAUTION

DUE TO THE HIGH TEMPERATURES THAT CAN BE REACHED IN THE CATALYTIC CONVERTER, WHEN PARKING THE VEHICLE, PAY ATTENTION TO THE MUFFLER: TO AVOID SERIOUS BURNS OR FIRE, THE MUFFLER SHOULD NEVER COME INTO CONTACT WITH FLAMMABLE MATERIALS.

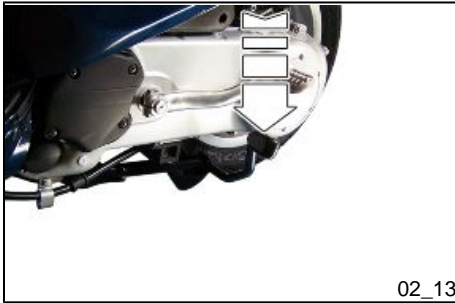

02_13

Stand (02_13)**Centre stand**

Push with your foot on the centre stand's fork "A" while lifting the vehicle backward, using the handlebar.

CAUTION

PARK THE MOTORCYCLE ON SAFE AND LEVEL GROUND.

CAUTION

DUE TO THE HIGH TEMPERATURES THE CATALYTIC CONVERTER CAN REACH, ALWAYS TAKE CARE, WHEN PARKING THE VEHICLE, THAT THE SILENCER DOES NOT COME INTO CONTACT WITH FLAMMABLE MATERIALS, TO AVOID SERIOUS BURNS.



02_14

Automatic transmission (02_14)

To ensure simple, pleasurable riding, the vehicle is equipped with automatic transmission with regulator and centrifugal clutch. The system is designed to give the best possible performance in terms of both acceleration and consumption, on level ground and uphill, thanks to the adjustments made to engine speed and transmitted torque. If you have to stop on an uphill slope (traffic lights, traffic jam, etc.) only use the brake to keep the vehicle still, leaving the motor running at idling speed. Using the motor to keep the vehicle still can cause the clutch to overheat. This problem is due to the friction of the clutch parts on the clutch bell. It is therefore recommended to avoid conditions of prolonged clutch slippage leading to clutch overheating (for example, as well as the situation described above, riding uphill fully laden on steep slopes or starting off on slopes greater than 25%, etc.):

1. Do not continue riding in such conditions.
2. Let the clutch cool down with the motor at idling speed for a few minutes

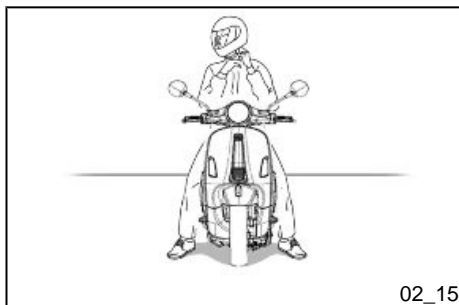

02_15

Safe driving (02_15)

Some simple tips are provided below that will enable you to use your vehicle on a daily basis in greater safety and peace of mind. Your skill and your mechanical knowledge are the basis of a safe ride. We recommend trying out the vehicle in traffic - free zones, in order to acquire a good knowledge of the vehicle itself.

1. Before riding off, remember to put the helmet on and fasten it correctly.
2. Reduce speed on rough roads and ride with care.
3. After riding on a long stretch of wet road without using the brakes, braking can be poor at the beginning. In these conditions, it is a good idea to apply the brakes from time to time.
4. Do not brake hard on wet, unsurfaced or slippery roads.

5. Avoid riding off by mounting the scooter when it is resting on its support. In any case, in order to avoid abrupt departures, the rear wheel should not be turning when it comes into contact with the ground.

6. If the vehicle is used on roads covered with sand, mud, snow mixed with salt, etc., clean the brake disc frequently with a mild detergent in order to prevent abrasive particles from building up inside the holes, which can result in early brake pad wear.

CAUTION

ALWAYS RIDE WITHIN YOUR LIMITS. RIDING UNDER THE INFLUENCE OF ALCOHOL OR OTHER DRUGS AND CERTAIN MEDICINES IS EXTREMELY DANGEROUS.

CAUTION

ANY ELABORATION THAT MODIFIES THE VEHICLE'S PERFORMANCES, SUCH AS TAMPERING WITH ORIGINAL STRUCTURAL PARTS IS STRICTLY FORBIDDEN BY LAW, AND RENDERS THE VEHICLE NO LONGER CONFORMING TO THE APPROVED TYPE AND DANGEROUS FOR RIDING.

CAUTION

DO NOT ADJUST THE MIRRORS WHILE RIDING. THIS COULD CAUSE YOU TO LOOSE CONTROL OF THE VEHICLE.

WARNING

IN ORDER TO PREVENT ANY ACCIDENTS RIDE VERY CAREFULLY AFTER ADDING ACCESSORIES AND WHILE CARRYING LUGGAGE. THE ADDITION OF

ACCESSORIES AND LUGGAGE CAN REDUCE YOUR SCOOTER STABILITY AND PERFORMANCE, AS WELL AS THE LEVEL OF SAFETY DURING USE. (SEE THE «SPARE PARTS AND ACCESSORIES» SECTION)

VESPA PRIMAVERA 50 2T

Vespa®



**Chap. 03
Maintenance**



03_01

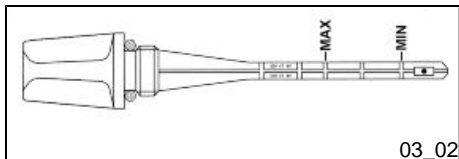

03_02

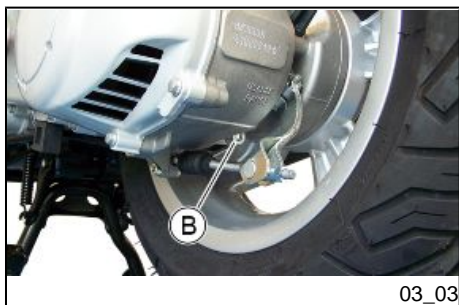

03_03

Hub oil level (03_01, 03_02, 03_03)

To check the hub oil level, proceed as follows:

1. Place the vehicle on its stand on a level surface;
2. Unscrew the oil dipstick «A», dry it with a clean rag and then reinsert it, **screwing it tightly into place**;
3. Unscrew the dipstick again and check that the oil level barely reaches the **2nd notch from the bottom**;
4. Screw the dipstick back into place completely.

The screw «B» is the hub oil drainage plug.

CAUTION



RUNNING THE ENGINE WITH INSUFFICIENT LUBRICATION OR WITH THE INADEQUATE LUBRICANTS ACCELERATES WEAR AND TEAR OF THE MOVING PARTS AND CAN CAUSE IRRETRIEVABLE DAMAGE.

CAUTION



USED OILS CONTAIN SUBSTANCES HARMFUL TO THE ENVIRONMENT. FOR OIL REPLACEMENT, CONTACT AN AUTHORISED SERVICE CENTRE WHICH IS EQUIPPED TO DISPOSE OF USED OILS IN AN ENVIRONMENTALLY FRIENDLY AND LEGAL WAY.

N.B.

THE NOTCHES ON THE HUB OIL LEVEL DIPSTICK, EXCEPT THE ONE INDICATING THE MAXIMUM AND MINIMUM LEVEL, REFER TO OTHER MODELS BY THE MANUFACTURER AND HAVE NO SPECIFIC FUNCTION FOR THIS MODEL.

Recommended products

AGIP GEAR SAE 80W-90

Lubricant for gearboxes and transmissions.
API GL-4

Characteristic

Transmission oil

80 cm³

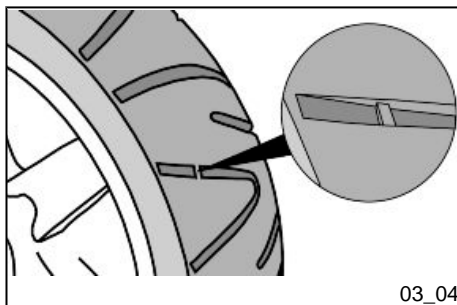

Tyres (03_04)

Periodically check the inflation pressure of each tyre (when cold).

Tyres are fitted with wear indicators; tyres should be replaced as soon as these indicators become visible on the tyre tread. Also check that the tyres do not show signs of splitting at the sides or irregular tread wear; If this occurs, go to an authorised workshop or at least a workshop adequately equipped to remove and refit tyres.

CAUTION



TYRE PRESSURE SHOULD BE CHECKED WHEN TYRES ARE COLD. INCORRECT TYRE PRESSURE CAUSES ABNORMAL TYRE WEAR AND MAKES RIDING DANGEROUS.

TYRES MUST BE REPLACED WHEN THE TREAD REACHES THE WEAR LIMITS SET FORTH BY LAW.

TYRES

Front tyre	Tubeless, 110/70 - 11" 45L
Rear tyre	Tubeless, 120/70 - 11" 56L

TYRE INFLATION PRESSURE

Front tyre pressure	1.6 bar
Rear tyre pressure	1.8 bar

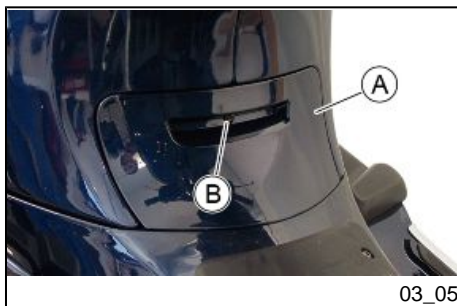

Spark plug dismantlement (03_05, 03_06)

Removal

In order to inspect the spark plug, follow the operation described when the engine is cold:

- Slide off the spark plug inspection cover «A» by unscrewing the screw «B».
- Slide off the spark plug tube «C».
- Remove the spark plug using the box-spanner supplied.

Fitting

- Use the box-spanner to refit the spark plug in its saddle, then tighten it. Care should be taken while installing and fixing it with the correct inclination.
- Insert the spark plug tube «C».
- Place the inspection cover «A» and tighten the screw «B».

CAUTION



FOLLOW THESE PROCEDURES VERY CAREFULLY TO AVOID ANY SEVERE DAMAGE THAT MAY BE CAUSED BY THE VERY POWERFUL IGNITION SYSTEM.

CAUTION

THE SPARK PLUG MUST BE REMOVED WHEN THE ENGINE IS COLD.

USING IGNITION ELECTRONIC CENTRAL UNITS OR SPARK PLUGS OTHER THAN THE TYPES PRESCRIBED (SEE «TECHNICAL DATA» SECTION) CAN CAUSE SERIOUS DAMAGE TO THE ENGINE.

CAUTION

PROCEED WITH CAUTION.

DO NOT DAMAGE THE TONGUES OR THEIR SEATS. HANDLE THE PAINTED AND PLASTIC COMPONENTS CAREFULLY. DO NOT SCRATCH OR DAMAGE THEM.

Characteristic

Spark plug

CHAMPION RN3C

Removing the air filter

To remove and clean the air filter, follow the indications in the scheduled maintenance table, contact an **Authorised Service Centre**.

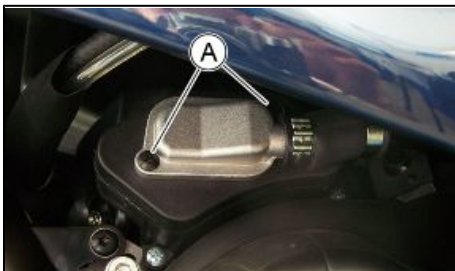

03_07

Secondary air system (03_07)

Remove the two screws «A» from the aluminium SAS cover. Release the metal tube from the rubber housing on the cover without extracting the tube from the cover/sleeve. Remove the tab and plastic cover, extract the sponge and wash it in water and soap.

Dry it with compressed air before refitting it, making sure to correctly fit the tab in the housing on the two plastic and aluminium covers. Every time the filter is removed, replace the housing O-ring seal of the cover.

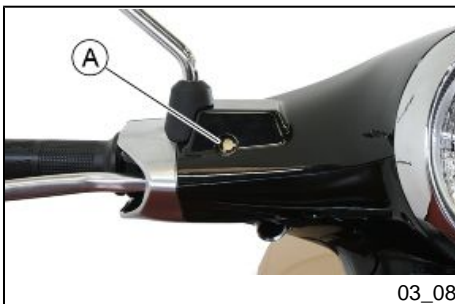

03_08

Checking the brake oil level (03_08)

The tank of the brake fluid is placed on the right side of the handlebar, under the handlebar cover.

To control the brake fluid level, proceed as follows:

- rest the vehicle on its centre stand and with the handlebars perfectly horizontal;
- control the level with the relative inspection sight glass «A», visible on the right front side of the handlebar cover:
 - if the sight glass is **full**, the brake fluid level is correct.
 - If the brake fluid level is certified to the reference «**MIN**», go to an **Authorised Service Centre** or carry out the top-up as indicated.
 - If the brake fluid level is lower than the reference «**MIN**», do not use the vehicle and contact an **Authorised Service Centre**.

Braking system fluid top up (03_09, 03_10, 03_11, 03_12)

To access the brake fluid tank, the upper handlebar cover must be removed, proceed as follows:

- Remove the rear-view mirrors.
- Remove on both sides of the vehicle the screw «A» fixing the surround of the headlight assembly.
- Remove the surround of the headlight assembly by releasing it from the upper fixing.

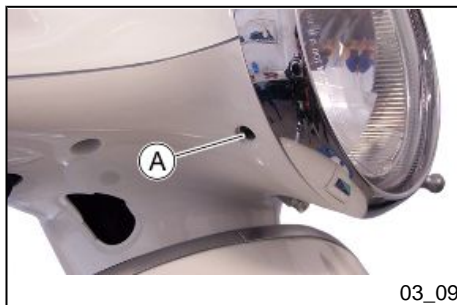

- Remove the two screws «B».

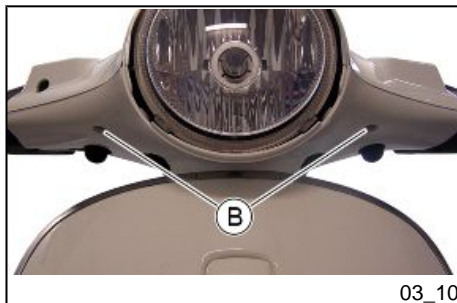

- Remove the two screws «C».

- Detach the upper handlebar cover, complete with instrument panel, from the lower one, supporting it on the leg shield back plate and paying attention to the instrument panel connector.



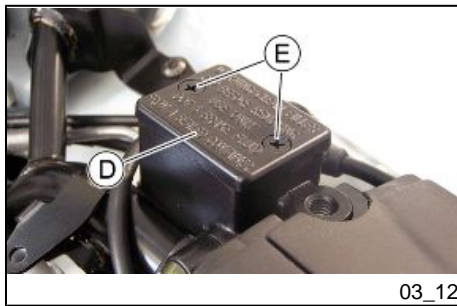

- Remove the tank cover «D» after sliding off the two fixing screws «E».
- Refill with the prescribed brake fluid type only, paying attention not to exceed the maximum allowed level and indicated by the inspection sight glass.

Under standard climatic conditions, replace fluid as indicated in the scheduled maintenance table. This operation must be carried out by trained technicians, please contact your nearest **Dealer or Authorised Service Centre**.

WARNING



ONLY USE DOT 4 CLASS BRAKE FLUIDS. BRAKING CIRCUIT FLUIDS ARE HIGHLY CORROSIVE. MAKE SURE THAT IT DOES NOT COME INTO CONTACT WITH THE PAINTWORK.

CAUTION



AVOID CONTACT OF BRAKE FLUID WITH EYES, SKIN, AND CLOTHING. IN CASE OF CONTACT, RINSE WITH WATER. THE BRAKING CIRCUIT FLUID IS HYGROSCOPIC, THAT IS, IT ABSORBS HUMIDITY FROM THE SURROUNDING AIR. IF THE HUMIDITY IN THE BRAKING FLUID EXCEEDS A CERTAIN VALUE, IT WILL LEAD TO INEFFICIENT BRAKING. NEVER USE BRAKING FLUID KEPT IN CONTAINERS THAT HAVE ALREADY BEEN OPENED, OR PARTIALLY USED.

Recommended products

AGIP BRAKE 4

Brake fluid.

Synthetic fluid SAE J 1703 - FMVSS 116 - DOT 3/4 - ISO 4925 - CUNA NC 956 DOT 4

FITTING

To fit the removed components to access the brake fluid tank, work in reverse order what is described in the instructions of this paragraph.

Battery (03_13, 03_14)

To access the battery, it is necessary to proceed as follows:

- Undo the four screws «**A**» and remove the rubber cover at the centre of the footrest.
- Remove the battery fixing bracket by unscrewing the two screws «**B**».

The battery is the electrical device that requires the most frequent attention and the most thorough maintenance.

WARNING

USED BATTERIES ARE HARMFUL FOR THE ENVIRONMENT. COLLECTION AND DISPOSAL SHOULD BE CARRIED OUT IN COMPLIANCE WITH REGULATIONS IN FORCE.

CAUTION

ELECTROLYTE CONTAINS SULPHURIC ACID: AVOID CONTACT WITH EYES, SKIN AND CLOTHES. IN CASE OF ACCIDENTAL CONTACT, RINSE WITH ABUNDANT WATER AND CONSULT A DOCTOR.

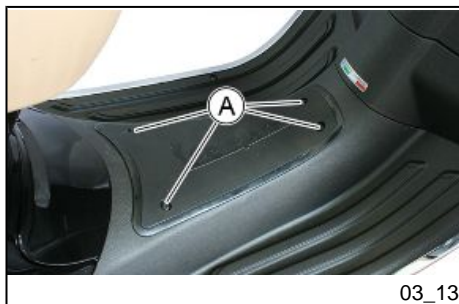

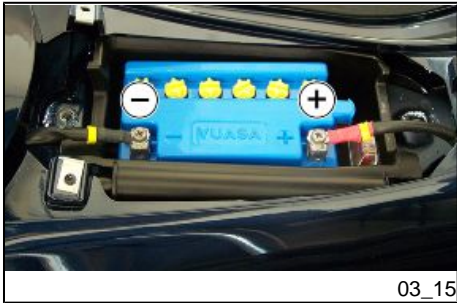
**CAUTION**

IN ORDER TO AVOID DAMAGING THE ELECTRICAL SYSTEM, NEVER DISCONNECT THE WIRING WHILE THE ENGINE IS RUNNING. DO NOT TIP THE VEHICLE TOO MUCH IN ORDER TO AVOID DANGEROUS LEAKAGE OF THE BATTERY ELECTROLYTE.

Use of a new battery (03_15)

To install a new battery:

- Place the battery in its housing.
- Connect the positive pole «+» first and then the negative pole «-».
- Place the fixing bracket and the battery cover, working in reverse order what is described in the instructions of the «Battery» paragraph.

CAUTION

DO NOT REVERSE THE POLARITY: RISK OF SHORT CIRCUIT AND DAMAGE TO THE ELECTRICAL SYSTEM.

WARNING

USED BATTERIES ARE HARMFUL FOR THE ENVIRONMENT. COLLECTION AND DISPOSAL SHOULD BE CARRIED OUT IN COMPLIANCE WITH REGULATIONS IN FORCE.

Characteristic

Battery

12 V / 4 Ah

Checking the electrolyte level

The electrolyte level, which should be checked regularly, must always be at the maximum level. To reach this level, use only distilled water. Should it become necessary to top up the battery with water too frequently, check the vehicle's electrical system because the battery is being overloaded, causing it to lose power quickly.

CAUTION



ELECTROLYTE CONTAINS SULPHURIC ACID: AVOID CONTACT WITH EYES, SKIN AND CLOTHES. IN CASE OF ACCIDENTAL CONTACT, RINSE WITH ABUNDANT WATER AND CONSULT A DOCTOR.

Long periods of inactivity (03_16)

Battery performance will be poor if the vehicle is not used for a long time. This is the result of the natural phenomenon of battery discharging, and may be due to residual absorption by vehicle components with constant power consumption. Poor battery performance may also be due to environmental conditions and the cleanliness of the poles. In order to avoid difficult starts and/or irreversible damage to the battery, follow any of these steps:

- **At least once a month** start the engine and run it slightly above idle speed for 10-15 minutes. This keeps all the engine components, as well as the battery, in good working order.



- Take your vehicle to a garage (as indicated in the «Vehicle not used for extended periods» section) to have the battery removed. Have the battery cleaned, charged fully and stored in a dry, ventilated place. Recharge **at least once every two months**.

N.B.

THE BATTERY MUST BE CHARGED WITH A CURRENT EQUAL TO 1/10 OF THE RATED CAPACITY OF THE BATTERY AND FOR NOT LONGER THAN 10 HOURS. CONTACT AN AUTHORISED SERVICE CENTRE TO CARRY OUT THIS OPERATION SAFELY. WHEN REFITTING THE BATTERY MAKE SURE THE LEADS ARE CORRECTLY CONNECTED TO THE TERMINALS.

WARNING

DO NOT DISCONNECT THE BATTERY CABLES WITH THE ENGINE RUNNING, THIS CAN CAUSE IRREPARABLE DAMAGE TO THE VEHICLE'S ELECTRONIC CONTROL UNIT.

WARNING

USED BATTERIES ARE HARMFUL FOR THE ENVIRONMENT. COLLECTION AND DISPOSAL SHOULD BE CARRIED OUT IN COMPLIANCE WITH REGULATIONS IN FORCE.



03_17

Fuses (03_17)

The electrical system is protected by a fuse valve «A» located in the battery compartment. Before replacing a blown fuse, find and solve the problem that caused it to blow. Do not replace the fuse with any alternative form of conductor

Electric characteristic

Fuse

10 A

CAUTION



BEFORE REPLACING THE FUSE IT IS NECESSARY TO FIND AND SOLVE THE FAILURE THAT CAUSED IT TO BLOW.

DO NOT REPLACE THE FUSE WITH ANY ALTERNATIVE FORM OF CONDUCTOR.

CAUTION



IN ORDER TO AVOID DAMAGING THE ELECTRICAL SYSTEM, NEVER DISCONNECT THE WIRING WHILE THE ENGINE IS RUNNING. DO NOT TIP THE VEHICLE TOO MUCH IN ORDER TO AVOID DANGEROUS LEAKAGE OF THE BATTERY ELECTROLYTE.

CAUTION



MODIFICATIONS OR REPAIRS TO THE ELECTRICAL SYSTEM, PERFORMED INCORRECTLY OR WITHOUT STRICT ATTENTION TO THE TECHNICAL SPEC-

IFICATIONS OF THE SYSTEM CAN CAUSE MALFUNCTIONING AND RISK OF FIRE.

CAUTION



PROCEED WITH CAUTION.

DO NOT DAMAGE THE TONGUES OR THEIR SEATS. HANDLE THE PAINTED AND PLASTIC COMPONENTS CAREFULLY. DO NOT SCRATCH OR DAMAGE THEM.

BULBS

High/low beam light bulb	Type: Halogen (HS1) Power: 12V - 35/35W Quantity: 1
--------------------------	--

Stop light bulb	Type: LED Quantity: 1
-----------------	--

rear daylight running light bulb	Type: Incandescent Power: 12V - 10W Quantity: 1
----------------------------------	--

Front turn indicator light bulb	Type: Halogen, BAZ9s base, Amber
---------------------------------	---

Power: 12V - 6W

Quantity: 1 RHS + 1 LHS

Rear turn indicator light bulb

Type: Halogen, BAZ9s base, Amber

Power: 12V - 6W

Quantity: 1 RHS + 1 LHS

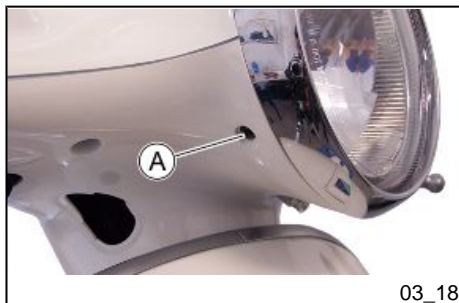

Front light group (03_18, 03_19, 03_20, 03_21, 03_22)

To access the bulb of the front headlight assembly, the upper handlebar cover must be removed, proceed as follows:

- Remove the rear-view mirrors.
- Remove on both sides of the vehicle the screw «A» fixing the surround of the headlight assembly.
- Remove the surround of the headlight assembly by releasing it from the upper fixing.



- Remove the two screws «B».



03_20

- Remove the two screws «C».

- Detach the upper handlebar cover, complete with instrument panel, from the lower one, supporting it on the leg shield back plate and paying attention to the instrument panel connector.

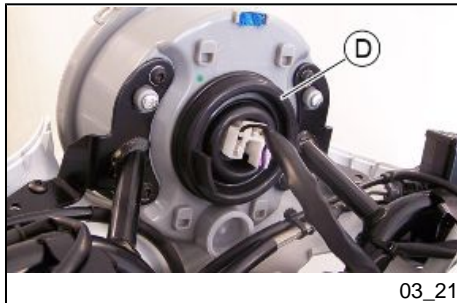

03_21

HIGH/LOW BEAM LIGHT BULB

- Disconnect, by sliding the electric connector off.

- Remove the rubber protection «D».

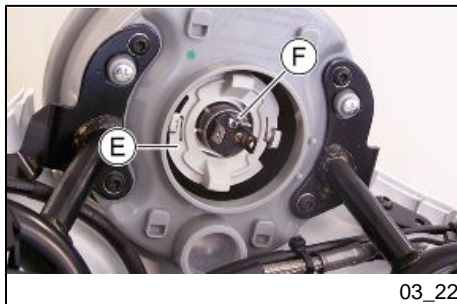

03_22

- Turn it anticlockwise, remove the ring nut «E».

- Slide off the bulb «F» and replace it with one of the same electric characteristics.

- When refitting, pay attention to the correct positioning of the rubber protection.

CAUTION

DO NOT PULL THE ELECTRICAL CABLES WHEN TAKING OUT THE BULB ELECTRICAL CONNECTOR.

N.B.

IF MISTING IS NOTICED ON THE INSIDE OF THE TAIL LIGHT, CHECK THAT IT DISAPPEARS AFTER SOME MINUTES OF IGNITION OF THE TAIL LIGHT. IT IS

A COMMON PHENOMENON AND IS ATTRIBUTABLE TO HUMIDITY AND/OR TO LOW TEMPERATURES; DOES NOT SHOW FAILURE.

THE PRESENCE OF DROPS OF WATER, ON THE OTHER HAND, COULD INDICATE THAT WATER IS INFILTRATING. CONTACT AN AUTHORISED SERVICE CENTRE.

CAUTION



DO NOT PLACE, TRANSPORT OBJECTS AND/OR CLOTHES OVER THE FRONT HEADLIGHT ASSEMBLY, WHEN THE HEADLIGHT IS TURNED ON OR OFF. FAILURE TO FOLLOW THIS PRECAUTION MAY CAUSE OVERHEATING AND THE SUBSEQUENT FUSION OF THE GLASS.

Head light adjustment (03_23, 03_24)

Proceed as follows:

- Position the vehicle in running order and with the tyres inflated to the prescribed pressure, onto a flat surface, 10 m away from a half-lit white screen; ensure that the longitudinal axis of the vehicle is perpendicular to the screen;
- Turn on the headlight and check that the borderline of the projected light beam on the screen is not higher than $9/10$ or lower than $7/10$ of the distance from the ground to the centre of the vehicle headlamp;
- If this is not the case, adjust the headlight by operating the screw «A».

N.B.

THE ABOVE PROCEDURE COMPLIES WITH THE EUROPEAN STANDARDS REGARDING MAXIMUM AND MINIMUM HEIGHT OF LIGHT BEAMS. REFER TO THE STATUTORY REGULATIONS IN FORCE IN EVERY COUNTRY WHERE THE VEHICLE IS USED.

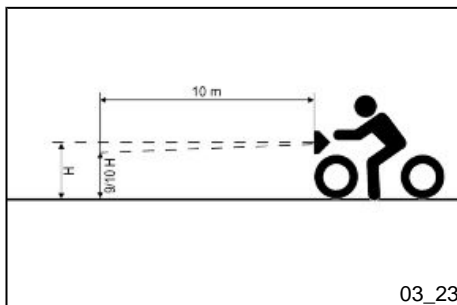

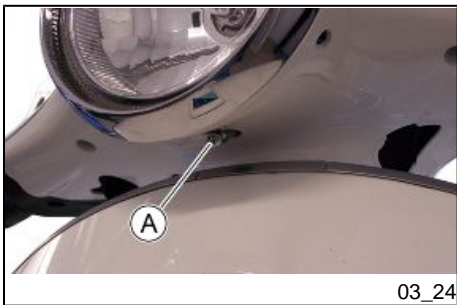

Front direction indicators (03_25, 03_26)

To replace the bulbs:

- Open the front case and remove the rubber cap «A».

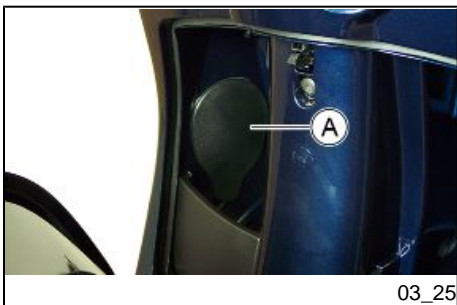

- Take out the bulb holder «B» from its fitting by turning it anticlockwise.
- Press the bulb, turn it anticlockwise and then take it out.

To refit, proceed in reverse order.

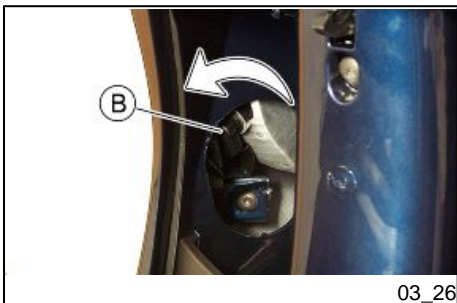



03_27

Rear optical unit (03_27, 03_28, 03_29)

To replace the taillight bulb:

- Remove the knob-type head «A» fixing the rear headlight assembly, can be reached from the wheel housing on the left side of the vehicle.
- Slide off the headlight assembly by pulling it towards the base and releasing the two upper fixings.
- Take out the bulb holder «B» from its fitting by turning it anticlockwise.
- Press the bulb, turn it anticlockwise and then take it out.

To refit, proceed in reverse order.

N.B.

IF MISTING IS NOTICED ON THE INSIDE OF THE HEADLAMP GLASS, THIS DOES NOT INDICATE A FAULT AND IS ATTRIBUTABLE TO HUMIDITY AND/OR TO LOW TEMPERATURES.

THE PHENOMENON SHOULD QUICKLY DISAPPEAR WHEN THE LIGHT IS SWITCHED ON.

THE PRESENCE OF DROPS OF WATER, ON THE OTHER HAND, COULD INDICATE THAT WATER IS INFILTRATING. CONTACT THE AFTER-SALES SERVICE NETWORK.



03_28

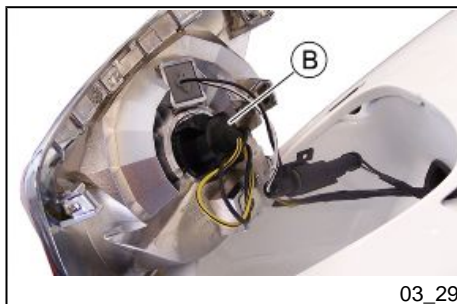

03_29



Rear turn indicators (03_30, 03_31)

To replace the bulbs:

- remove the turn indicator from its seat by undoing the screw «A».

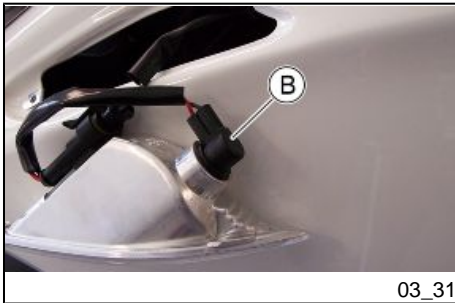

- Take out the bulb holder «B» from its fitting by turning it anticlockwise.

- Press the bulb, turn it anticlockwise and then take it out.

To refit, proceed in reverse order.

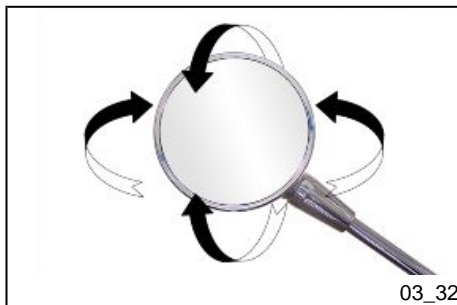

03_32

Rear-view mirrors (03_32, 03_33)

The mirrors can be set to the desired position by adjusting the mirror frame.

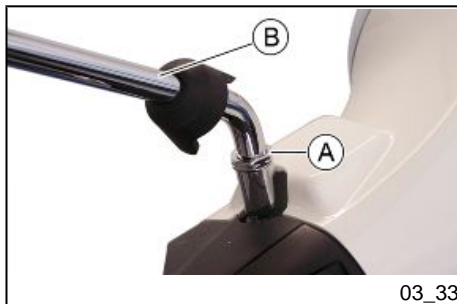

03_33

To remove the rear view mirror, lift the rubber protection, unscrew the lock nut «A» slightly to unlock the stem. Unscrew the stem «B» until removing it.

CAUTION



DO NOT ADJUST THE MIRRORS WHILE RIDING. THIS COULD CAUSE YOU TO LOOSE CONTROL OF THE VEHICLE.

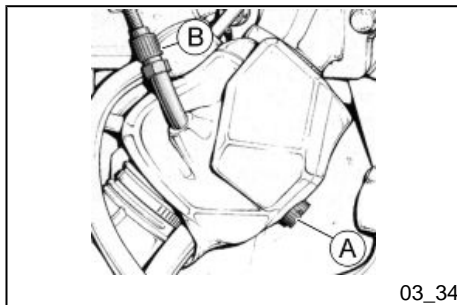

03_34

Idle adjustment (03_34)

The idle speed is adjusted by means of the idle speed adjuster screw «A» located on the carburettor.

To do this, proceed as shown in the diagram. Turn the set screw for clearance adjustment of the throttle control transmission «B», then replace the rubber protection cap.

Adjust idle speed with the rear wheel off the ground (vehicle on stand) and with a warm engine. Screw or unscrew the knob-type head screw until the engine idles smoothly, **i.e. without the rear wheel being moved by the engine.**

If the adjustment in these conditions is difficult, contact an **Authorised Service Centre**.

CAUTION



WHEN ADJUSTING IDLE SPEED, BE CAREFUL NOT TO TOUCH HOT PARTS OF THE ENGINE TO AVOID BURNS.

Characteristic

Engine idle speed

1,800 ± 100 rpm



Front disc brake (03_35)

The brake disc and pad wear is automatically compensated, therefore it has no effect on the functioning of the front and rear brakes. For this reason it is not necessary to adjust the brakes. An excessively elastic brake lever stroke may indicate the presence of air in the braking circuit or a failure in the braking system. In this case, mainly due to the importance of brakes to guarantee safe riding conditions, the vehicle should be taken to an **Authorised Service Centre or Dealer**.

CAUTION



BRAKING SHOULD BEGIN AFTER ABOUT 1/3 OF THE BRAKE LEVER STROKE.

CAUTION



HAVE THE BRAKE PADS CHECKED BY THE DEALER ACCORDING TO THE CHECKS SPECIFIED IN THE SCHEDULED MAINTENANCE TABLE. HOWEVER, IN THE EVENT OF NOISES COMING FROM THE FRONT AND/OR REAR BRAKING SYSTEM DURING OPERATION, IT IS ADVISABLE TO HAVE THE BRAKING SYSTEM CHECKED BY AN AUTHORISED SERVICE CENTRE OR DEALER. AFTER REPLACING THE BRAKE PADS, DO NOT USE THE SCOOTER UNTIL YOU HAVE OPERATED THE BRAKE LEVER SEVERAL TIMES IN ORDER TO ALLOW THE PLUNGERS TO SETTLE AND THE LEVER STROKE TO BE SET TO THE CORRECT POSITION.

CAUTION



THE PRESENCE OF SAND, MUD, SNOW MIXED WITH SALT, ETC. ON THE ROAD, CAN DRASTICALLY REDUCE THE LIFE OF THE BRAKE PADS. IN ORDER TO AVOID THIS, WE RECOMMEND WASHING THE VEHICLE FREQUENTLY WHEN RIDING IN THESE ROAD CONDITIONS.

Rear drum brake (03_36)

Operate adjusting nut «B» and loosen lock nut «A» shown in the figure. Note that when the throttle is in idle **the wheel should rotate free**. After the adjustment, screw lock nut «A».

CAUTION



BRAKING SHOULD BEGIN AFTER ABOUT 1/3 OF THE BRAKE LEVER STROKE.

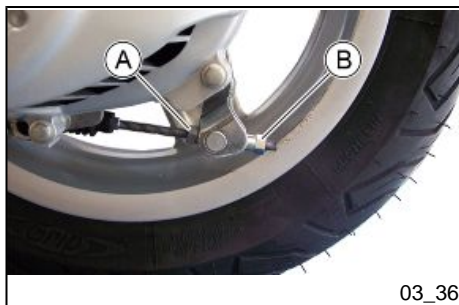

03_36

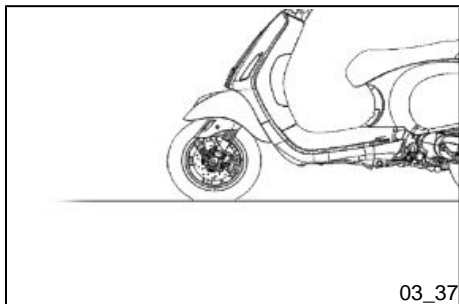

03_37

Puncture (03_37)

The vehicle is equipped with Tubeless tyres (without inner tube). In the event of a puncture, Tubeless tyres - unlike tyres with inner tubes - go flat very slowly, resulting in a greater steering safety. In the event of a puncture, an emergency repair can be carried out using an "inflate and repair" spray can. For a final repair, take your vehicle to an **Authorised Service Centre or Dealer**. The replacement of a tyre involves removing the wheel in question. Take your vehicle to an **Authorised Service Centre or Dealer** for these operations.

CAUTION



TO USE THE "INFLATE AND REPAIR" SPRAY CAN PROPERLY, FOLLOW THE INSTRUCTIONS ON THE PACKAGING.



03_38

Inactivity of the vehicle (03_38)

The following operations are recommended:

1. Clean the scooter thoroughly and then cover it with a canvas;
2. With the engine off, remove the spark plug and pour 1 - 2 cm³ of oil through its hole (greater quantities are harmful to the integrity of the engine itself). Operate the starter button 1-2 times for roughly 1 second to turn the engine over slowly, then insert the spark plug again;
3. Drain all the fuel from the scooter; spread anti rust grease on the uncoated metal parts; keep the wheels lifted above the ground by resting the chassis on two wooden wedges;
4. As regards the battery, follow the instructions in the «Battery» section.

Recommended products

eni i-Ride PG 2s

Synthetic based lubricant for low smoke 2-stroke engines and additives.

API TC - JASO FC - ISO-L-EGD

Cleaning the vehicle

Use a low pressure jet of water to soften the caked dirt and mud deposited on the painted surfaces. Once softened, sponge off mud and dirt using a car body sponge soaked in a car body shampoo and water solution (2-4% of car shampoo in water). Then rinse with abundant water, and dry with a shammy cloth. For the engine exterior, use petrol, a brush and clean cloths. Petrol can damage paintwork. Remember that any polishing with silicone wax must always be preceded by washing.

CAUTION



DETERGENTS CAN POLLUTE WATER. THE VEHICLE MUST BE WASHED AT A WASH STATION EQUIPPED WITH A SPECIAL WATER PURIFICATION SYSTEM.

CAUTION



DO NOT USE A HIGH-PRESSURE WATER JET MACHINE TO CLEAN THE ENGINE AND/OR VEHICLE; HOWEVER, IF NO OTHER MEANS ARE AVAILABLE, IT IS THEN NECESSARY TO:

- **ONLY USE A FAN-LIKE SPRAY JET.**
- **DO NOT PLACE THE NOZZLE CLOSER THAN 60 CM.**
- **DO NOT USE WATER AT TEMPERATURES OVER 40°C.**

- DO NOT USE HIGH-PRESSURE WATER JETS.
- DO NOT STEAM WASH.
- DO NOT AIM THE JET AT: THE ENGINE, THE WIRING, THE COOLING SLITS ON THE TRANSMISSION OR SCROLL COVERS.

CAUTION



NEVER WASH THE SCOOTER IN DIRECT SUNLIGHT, ESPECIALLY IN SUMMER WHEN THE BODYWORK IS STILL HOT AS THE SHAMPOO COULD DAMAGE THE PAINTWORK IF IT DRIES BEFORE BEING RINSED OFF. NEVER USE CLOTHS SOAKED IN ALCOHOL, PETROL, DIESEL OIL OR KEROSENE FOR CLEANING THE PAINTED OR PLASTIC SURFACES, IN ORDER NOT TO DAMAGE THE LUSTRE FINISH OR ALTER THEIR MECHANICAL PROPERTIES. USING SILICONE-BASED WAX CAN DAMAGE THE PAINTED SURFACES, DEPENDING ON THE VEHICLE COLOUR (SATIN COLOURS). FOR FURTHER INFORMATION ON THIS MATTER, CONTACT AN AUTHORISED SERVICE CENTRE.

WARNING



CLEAN YOUR SCOOTER FREQUENTLY SO AS TO AVOID POSSIBLE DIRT OR MUD DEPOSITS THAT COULD CAUSE MALFUNCTIONING IN THE THROTTLE GRIP TRANSMISSION AND/OR OTHER COMPONENTS.

DIFFICULT STARTING

No fuel in tank

Refuel

Filters, jets or carburettor body dirty or clogged.	Contact an Authorised Service Centre .
Insufficient battery charge	Kick-start. Recharge the battery.

IGNITION PROBLEMS

No spark from spark plug. Due to the presence of high voltage, this check should only be carried out by an expert.	Make sure the electrodes are properly adjusted. Check that they are (clean with pure petrol and a metal brush or with emery cloth). Check the spark plug insulator: Replace the spark plug if the insulator is cracked or broken. If the spark plug is in good conditions, contact an Authorised Service Centre .
--	--

LACK OF COMPRESSION

Spark plug loose. Loose cylinder head, worn piston retaining rings.	Contact an Authorised Service Centre .
---	---

HIGH CONSUMPTION AND LOW PERFORMANCE

Air filter blocked or dirty.	Contact an Authorised Service Centre .
------------------------------	---

INEFFICIENT BRAKING

Oil on drum or disc. Worn Pads/ Shoes	Contact an Authorised Service Centre
--	---

incorrect rear brake adjustment	Adjust
---------------------------------	--------

INEFFICIENT SUSPENSION

Oil leak; worn limit switch bumpers; worn shock absorber attachment points	Contact an Authorised Service Centre
--	---

AUTOMATIC TRANSMISSION PROBLEMS

Deteriorated roller housing or belt.	Contact an Authorised Service Centre.
--------------------------------------	--

INCREASED EXHAUST NOISE

Deterioration of the SAS system and/or of the tab	Contact an Authorised Service Centre.
--	--

STAND DOES NOT RETURN TO POSITION

Presence of dirt

Clean and grease

STARTER LEVER DOES NOT RETURN TO CORRECT POSITION

Presence of dirt

Clean and grease

VESPA PRIMAVERA 50 2T

Vespa®



Chap. 04
Technical data

Data (04_01)

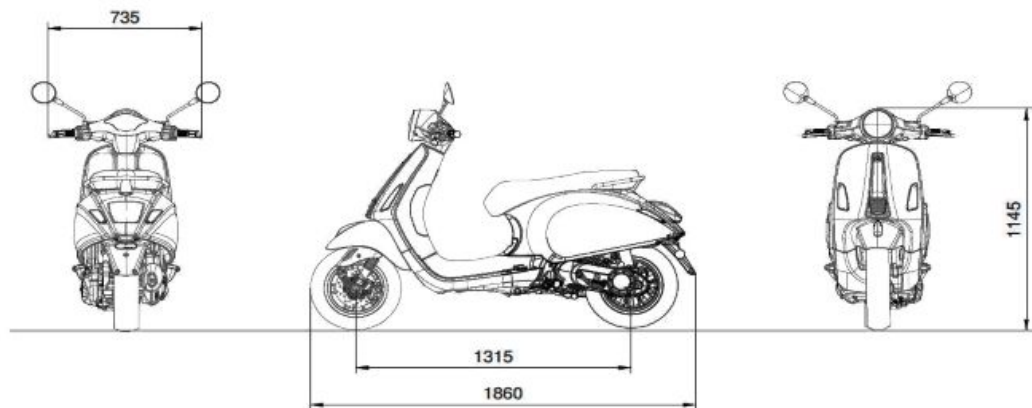

VEHICLE SPECIFICATIONS

Chassis	Stamped plate body with welded structural reinforcements.
Front suspension	Single arm with helical spring and single double-acting hydraulic shock absorber.
Rear suspension	Single-chamber shock absorber.
Front brake	Ø 200-mm disc brake with hydraulic control activated by handlebar right-side lever.
Rear drum	Ø 110-mm drum brake with mechanical control activated by handlebar left-side lever.
Wheel rim type	Light alloy.
Front wheel rim	11" x 2.50
Rear wheel rim	11" x 3.00
Front tyre	Tubeless, 110/70 - 11" 45L
Rear tyre	Tubeless, 120/70 - 11" 56L
Front tyre pressure	1.6 bar
Rear tyre pressure	1.8 bar
Kerb weight	102 ± 5 kg
Maximum weight allowed	295 kg
Battery	12 V / 4 Ah

ENGINE SPECIFICATIONS

Type	single-cylinder, two-stroke
Engine capacity	49 cm ³
Bore x stroke	40 X 39.3 mm
Compression ratio	9.9 ± 0.5: 1
Engine idle speed	1,800 ± 100 rpm
Max. power	3.2 kW at 7,500 rpm
MAX. torque	4.4 Nm at 6,500 rpm
Transmission	Automatic expandable pulley variator with torque server, V-belt, automatic centrifugal dry clutch.
Final reduction gear	Gear reduction unit in oil bath.
Lubrication	Lubrication of the engine with fuel mixture oil.
Cooling	Forced-air circulation cooling.
Starter	Starter and kick starter
Ignition	Capacitive discharge ignition, with variable advance and separate HV coil.
Spark plug	CHAMPION RN3C
Fuel system	DELL'ORTO PHVA 17.5 carburettor
Fuel	Unleaded petrol (95 RON) and oil.
Exhaust silencer	Absorption-type exhaust muffler with catalytic converter.

CAPACITIES

Transmission oil	80 cm ³
Fuel tank capacity	6.4 ± 0.1 l
Oil mix tank capacity	~ 1.3 l

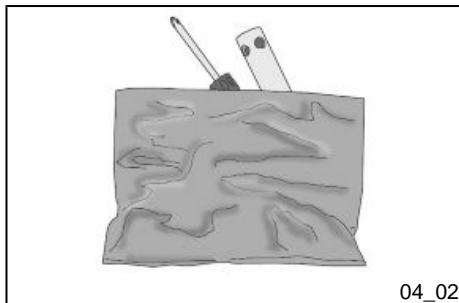
**Tool kit (04_02)**

The toolkit comprises:

- one box-spanner;
- one twin screwdriver;
- one fuse puller;
- one torx wrench.

The tools are stored in the helmet compartment.

VESPA PRIMAVERA 50 2T

Vespa®



**Chap. 05
Spare parts and
accessories**



Warnings (05_01)

WARNING



IT IS RECOMMENDED THAT "ORIGINAL PIAGGIO SPARE PARTS" BE USED, AS THESE ARE THE ONLY ONES OFFERING YOU THE SAME QUALITY ASSURANCE AS THOSE INITIALLY FITTED ON THE VEHICLE.

IT SHOULD BE REMEMBERED THAT USING NON-ORIGINAL SPARE PARTS CAUSES YOUR WARRANTY RIGHTS TO EXPIRE.

WARNING



PIAGGIO MARKETS ITS OWN LINE OF ACCESSORIES THAT ARE RECOGNISED AND GUARANTEED FOR USE. IT IS THEREFORE ESSENTIAL TO CONTACT AN AUTHORISED DEALER OR SERVICE CENTRE IN ORDER TO CHOOSE AND FIT ACCESSORIES CORRECTLY. THE USE OF NON-ORIGINAL ACCESSORIES MAY AFFECT THE STABILITY AND OPERATION OF YOUR VEHICLE AND REDUCE SAFETY LEVELS WITH POTENTIAL RISKS FOR THE RIDER.

VESPA PRIMAVERA 50 2T

Vespa®



**Chap. 06
Scheduled
maintenance**



06_01

Scheduled servicing table (06_01)

Adequate maintenance is fundamental to ensure long-lasting, optimum operation and performance of your vehicle.

To this end, a series of checks and maintenance operations (at the owner's expense) have been suggested, which are included in the summary table on the following page. Any minor faults should be reported without delay to an **Authorised Service Centre or Dealer** without waiting until the next scheduled service to solve it.

It is necessary to have your vehicle serviced to the prescribed intervals of time, even if you have not reached the predicted mileage. Carrying out scheduled services on time is essential for the validity of your warranty. For any further information concerning Warranty procedures and 'Scheduled Maintenance', please refer to the 'Warranty Booklet'.

SCHEDULED MAINTENANCE TABLE

km x 1,000	1	5	10	15	20	25	30	35	40	45	50	55	60
Safety fasteners	I		I		I		I		I		I		I
Spark plug		I	R	I	R	I	R	I	R	I	R	I	R
Drive belt			I	R	I		R		I	R	I		R
Mixer belt					R				R				R
Throttle control - mixer	A	A	A	A	A	A	A	A	A	A	A	A	A
Air filter		C	C	C	C	C	C	C	C	C	C	C	C
SAS filter			I	C	I		C		I	C	I		C
Electrical system and battery	I	I	I	I	I	I	I	I	I	I	I	I	I
Cylinder cooling system					I				I				
Brake levers	L	L	L	L	L	L	L	L	L	L	L	L	L

km x 1,000	1	5	10	15	20	25	30	35	40	45	50	55	60
Brake fluid **	I	I	I	I	I	I	I	I	I	I	I	I	I
Mixer	I	I	I	I	I	I	I	I	I	I	I	I	I
Mixer oil*	I	I	I	I	I	I	I	I	I	I	I	I	I
Hub oil	R	I	R	I	R	I	R	I	R	I	R	I	R
Headlight direction adjustment			A		A		A		A		A		A
Brake pads/shoes	I	I	I	I	I	I	I	I	I	I	I	I	I
Sliding shoes / CVT rollers			R		R		R		R		R		R
Tyre pressure and wear	I	I	I	I	I	I	I	I	I	I	I	I	I
Vehicle road test	I	I	I	I	I	I	I	I	I	I	I	I	I
Idle speed	A		A		A		A		A		A		A
Suspension			I		I		I		I		I		I
Steering	A		I		I		I		I		I		I
Transmission			L		L		L		L		L		L
Mixer oil pipes	I		I		I		I		I		I		I

I: INSPECT AND CLEAN, ADJUST, LUBRICATE OR REPLACE IF NECESSARY

C: CLEAN, R: REPLACE, A: ADJUST, L: LUBRICATE

Clean the SAS air filter every 2 years

** Check level every 500 km*

*** Replace every 2 years*

RECOMMENDED PRODUCTS TABLE

Product	Description	Specifications
AGIP GEAR SAE 80W-90	Lubricant for gearboxes and transmissions.	API GL-4
AGIP BRAKE 4	Brake fluid.	Synthetic fluid SAE J 1703 - FMVSS 116 - DOT 3/4 - ISO 4925 - CUNA NC 956 DOT 4
eni i-Ride PG 2s	Synthetic based lubricant for low smoke 2-stroke engines and additives.	API TC - JASO FC - ISO-L-EGD
AGIP FILTER OIL	Special product for the treatment of foam filters.	-
AGIP GREASE MU3	Yellow-brown, lithium-base, medium-fibre multipurpose grease.	ISO L-X-BCHA 3 - DIN 51 825 K3K -20
AGIP GP 330	Water repellent stringy calcium spray grease.	R.I.D./A.D.R. 2 10°b) 2 R.I.Na. 2.42 - I.A.T.A. 2 - I.M.D.G. class 2 UN 1950 Page 9022 EM 25-89

UNIT OF MEASURE - CONVERSION - ENGLISH SYSTEM TO INTERNATIONAL SYSTEM (IS).

1 Inch (in)	25.4 Millimetres (mm)
1 Foot (ft)	0.305 Meter (m)
1 Mile (mi)	1.609 Kilometre (km)
1 US Gallon (USgal)	3.785 Litre (l)
1 Pound (lb)	0.454 Kilogram (kg)
1 Cubic inch (in ³)	16.4 Cubic centimetres (cm ³)
1 Foot pound (lb ft)	1,356 Newton meter (Nm)

1 Miles per hour (mi/h)	1.602 Kilometres per hour (km/h)
1 Pound per square inch (PSI)	0.069 (bar)
1 Fahrenheit (°F)	$32 + (9/5)$ Celsius (°C)

TABLE OF CONTENTS

A

Air filter: 41

B

Battery: 45, 46
Brake: 42, 58, 59

C

Checks: 24

D

Disc brake: 58
Display: 11

F

Fuel: 17
Fuses: 49

H

Horn: 15
Hub oil: 38

I

Identification: 20
Instrument panel: 9

K

Keys: 20

L

Light switch: 16

M

Maintenance: 37, 75
Mirrors: 57

P

Puncture: 60

R

Refuelling: 24

S

Saddle: 18
Scheduled maintenance: 75
Spark plug: 40
Stand: 32
Start-up: 16
Switch: 15, 16

T

Tank: 17
Technical Data: 67
Top box: 21
Transmission: 33
Turn indicators: 56

Tyre pressure: 27

Tyres: 39

V

Vehicle: 7, 60, 61



The descriptions and images in this publication are given for illustrative purposes only and are not binding. While the basic characteristics as described and illustrated in this booklet remain unchanged, Piaggio & C. S.p.A. reserves the right, at any time and without being required to update this publication beforehand, to make any changes to components, parts or accessories, which it considers necessary to improve the product or which are required for manufacturing or construction reasons.

Not all versions/models shown in this publication are available in all countries. The availability of each model should be checked at the official PIAGGIO sales network.

© Copyright 2013 - Piaggio & C. S.p.A. All rights reserved. Reproduction of this publication in whole or in part is prohibited.

Piaggio & C. S.p.A. Viale Rinaldo Piaggio, 25 - 56025 PONTEDERA (PI), Italy

www.piaggio.com